

Agilent InfiniiVision 7000A Series Oscilloscopes

Programmer's Guide



Agilent Technologies

Notices

© Agilent Technologies, Inc. 2005-2010

No part of this manual may be reproduced in any form or by any means (including electronic storage and retrieval or translation into a foreign language) without prior agreement and written consent from Agilent Technologies, Inc. as governed by United States and international copyright laws.

Trademarks

Microsoft®, MS-DOS®, Windows®, Windows 2000®, and Windows XP® are U.S. registered trademarks of Microsoft Corporation.

Adobe®, Acrobat®, and the Acrobat Logo® are trademarks of Adobe Systems Incorporated.

Manual Part Number

Version 06.00.0000

Edition

January 21, 2010

Available in electronic format only

Agilent Technologies, Inc.
1900 Garden of the Gods Road
Colorado Springs, CO 80907 USA

Warranty

The material contained in this document is provided “as is,” and is subject to being changed, without notice, in future editions. Further, to the maximum extent permitted by applicable law, Agilent disclaims all warranties, either express or implied, with regard to this manual and any information contained herein, including but not limited to the implied warranties of merchantability and fitness for a particular purpose. Agilent shall not be liable for errors or for incidental or consequential damages in connection with the furnishing, use, or performance of this document or of any information contained herein. Should Agilent and the user have a separate written agreement with warranty terms covering the material in this document that conflict with these terms, the warranty terms in the separate agreement shall control.

Technology Licenses

The hardware and/or software described in this document are furnished under a license and may be used or copied only in accordance with the terms of such license.

Restricted Rights Legend

If software is for use in the performance of a U.S. Government prime contract or sub-contract, Software is delivered and licensed as “Commercial computer software” as defined in DFAR 252.227-7014 (June 1995), or as a “commercial item” as defined in FAR 2.101(a) or as “Restricted computer software” as defined in FAR 52.227-19 (June 1987) or any equivalent

agency regulation or contract clause. Use, duplication or disclosure of Software is subject to Agilent Technologies’ standard commercial license terms, and non-DOD Departments and Agencies of the U.S. Government will receive no greater than Restricted Rights as defined in FAR 52.227-19(c)(1-2) (June 1987). U.S. Government users will receive no greater than Limited Rights as defined in FAR 52.227-14 (June 1987) or DFAR 252.227-7015 (b)(2) (November 1995), as applicable in any technical data.

Safety Notices

CAUTION

A **CAUTION** notice denotes a hazard. It calls attention to an operating procedure, practice, or the like that, if not correctly performed or adhered to, could result in damage to the product or loss of important data. Do not proceed beyond a **CAUTION** notice until the indicated conditions are fully understood and met.

WARNING

A **WARNING** notice denotes a hazard. It calls attention to an operating procedure, practice, or the like that, if not correctly performed or adhered to, could result in personal injury or death. Do not proceed beyond a **WARNING** notice until the indicated conditions are fully understood and met.

In This Book

This book is your guide to programming the 7000A Series oscilloscopes:

Table 1 InfiniiVision 7000A Series Oscilloscope Models

Channels	Input Bandwidth			
	1 GHz	500 MHz	350 MHz	100 MHz
4 analog + 16 digital (mixed-signal)	MS07104A	MS07054A	MS07034A	MS07014A
2 analog + 16 digital (mixed-signal)		MS07052A	MS07032A	MS07012A
4 analog	DS07104A	DS07054A	DS07034A	DS07014A
2 analog		DS07052A	DS07032A	DS07012A

The first few chapters describe how to set up and get started:

- Chapter 1, [Chapter 1](#), “What's New,” starting on page 21, describes programming command changes in the latest version of oscilloscope software.
- Chapter 2, [Chapter 2](#), “Setting Up,” starting on page 35, describes the steps you must take before you can program the oscilloscope.
- Chapter 3, [Chapter 3](#), “Getting Started,” starting on page 45, gives a general overview of oscilloscope program structure and shows how to program the oscilloscope using a few simple examples.
- Chapter 4, [Chapter 4](#), “Commands Quick Reference,” starting on page 59, is a brief listing of the 7000 Series oscilloscope commands and syntax.

The next chapters provide reference information:

- Chapter 5, [Chapter 5](#), “Commands by Subsystem,” starting on page 111, describes the set of commands that belong to an individual subsystem and explains the function of each command. Command arguments and syntax are described. Some command descriptions have example code.
- Chapter 6, [Chapter 6](#), “Commands A-Z,” starting on page 653, contains an alphabetical listing of all command elements.
- Chapter 7, [Chapter 7](#), “Obsolete and Discontinued Commands,” starting on page 687, describes obsolete commands which still work but have been replaced by newer commands and discontinued commands which are no longer supported.

- Chapter 8, [Chapter 8](#), “Error Messages,” starting on page 743, lists the instrument error messages that can occur while programming the oscilloscope.

The command descriptions in this reference show upper and lowercase characters. For example, :AUToscale indicates that the entire command name is :AUTOSCALE. The short form, :AUT, is also accepted by the oscilloscope.

Then, there are chapters that describe programming topics and conceptual information in more detail:

- Chapter 9, [Chapter 9](#), “Status Reporting,” starting on page 751, describes the oscilloscope's status registers and how to check the status of the instrument.
- Chapter 10, [Chapter 10](#), “Synchronizing Acquisitions,” starting on page 775, describes how to wait for acquisitions to complete before querying measurement results or performing other operations with the captured data.
- Chapter 11, [Chapter 11](#), “More About Oscilloscope Commands,” starting on page 785, contains additional information about oscilloscope programming commands.

Finally, there is a chapter that contains programming examples:

- Chapter 12, [Chapter 12](#), “Programming Examples,” starting on page 811.

Mixed-Signal Oscilloscope Channel Differences

Because both the "analog channels only" oscilloscopes (DSO models) and the mixed-signal oscilloscopes (MSO models) have analog channels, topics that describe analog channels refer to all oscilloscope models. Whenever a topic describes digital channels, that information applies only to the mixed-signal oscilloscope models.

See Also

- For more information on using the SICL, VISA, and VISA COM libraries in general, see the documentation that comes with the Agilent IO Libraries Suite.
- For information on controller PC interface configuration, see the documentation for the interface card used (for example, the Agilent 82350A GPIB interface).
- For information on oscilloscope front-panel operation, see the *User's Guide*.
- For detailed connectivity information, refer to the *Agilent Technologies USB/LAN/GPIB Connectivity Guide*. For a printable electronic copy of the *Connectivity Guide*, direct your Web browser to "www.agilent.com" and search for "Connectivity Guide".
- For the latest versions of this and other manuals, see: "<http://www.agilent.com/find/7000manual>"

Contents

In This Book 3

1 What's New

What's New in Version 6.00	22
What's New in Version 5.25	25
What's New in Version 5.20	27
What's New in Version 5.15	30
What's New in Version 5.10	32
Version 5.00 at Introduction	33

2 Setting Up

Step 1. Install Agilent IO Libraries Suite software	36
Step 2. Connect and set up the oscilloscope	37
Using the USB (Device) Interface	37
Using the LAN Interface	37
Step 3. Verify the oscilloscope connection	39

3 Getting Started

Basic Oscilloscope Program Structure	46
Initializing	46
Capturing Data	46
Analyzing Captured Data	47

Programming the Oscilloscope	48
Referencing the IO Library	48
Opening the Oscilloscope Connection via the IO Library	49
Initializing the Interface and the Oscilloscope	49
Using :AUToscale to Automate Oscilloscope Setup	50
Using Other Oscilloscope Setup Commands	50
Capturing Data with the :DIGitize Command	51
Reading Query Responses from the Oscilloscope	53
Reading Query Results into String Variables	54
Reading Query Results into Numeric Variables	54
Reading Definite-Length Block Query Response Data	54
Sending Multiple Queries and Reading Results	55
Checking Instrument Status	56
Other Ways of Sending Commands	57
Telnet Sockets	57
Sending SCPI Commands Using Browser Web Control	57

4 Commands Quick Reference

Command Summary	60
Syntax Elements	108
Number Format	108
<NL> (Line Terminator)	108
[] (Optional Syntax Terms)	108
{ } (Braces)	108
::= (Defined As)	108
< > (Angle Brackets)	109
... (Ellipsis)	109
n,...,p (Value Ranges)	109
d (Digits)	109
Quoted ASCII String	109
Definite-Length Block Response Data	109

5 Commands by Subsystem

Common (*) Commands	113
*CLS (Clear Status)	117
*ESE (Standard Event Status Enable)	118
*ESR (Standard Event Status Register)	120
*IDN (Identification Number)	122
*LRN (Learn Device Setup)	123
*OPC (Operation Complete)	124

*OPT (Option Identification)	125
*RCL (Recall)	127
*RST (Reset)	128
*SAV (Save)	131
*SRE (Service Request Enable)	132
*STB (Read Status Byte)	134
*TRG (Trigger)	136
*TST (Self Test)	137
*WAI (Wait To Continue)	138
Root (:) Commands	139
:ACTivity	142
:AER (Arm Event Register)	143
:AUToscale	144
:AUToscale:AMODE	146
:AUToscale:CHANnels	147
:BLANK	148
:CDISplay	149
:DIGitize	150
:HWEenable (Hardware Event Enable Register)	152
:HWERegister:CONDition (Hardware Event Condition Register)	154
:HWERegister[:EVENT] (Hardware Event Event Register)	156
:MERGE	158
:MTEenable (Mask Test Event Enable Register)	159
:MTERegister[:EVENT] (Mask Test Event Event Register)	161
:OPEE (Operation Status Enable Register)	163
:OPERegister:CONDition (Operation Status Condition Register)	165
:OPERegister[:EVENT] (Operation Status Event Register)	167
:OVLenable (Overload Event Enable Register)	169
:OVLRegister (Overload Event Register)	171
:PRINt	173
:RUN	174
:SERial	175
:SINGle	176
:STATus	177
:STOP	178
:TER (Trigger Event Register)	179
:VIEW	180
:ACQuire Commands	181
:ACQuire:AALias	183
:ACQuire:COMPLete	184
:ACQuire:COUNt	185

:ACQuire:DAALias	186
:ACQuire:MODE	187
:ACQuire:POINts	188
:ACQuire:RSIGnal	189
:ACQuire:SEGMedent:ANALyze	190
:ACQuire:SEGMedent:COUNT	191
:ACQuire:SEGMedent:INDex	192
:ACQuire:SRATe	195
:ACQuire:TYPE	196
:BUS<n> Commands	198
:BUS<n>:BIT<m>	200
:BUS<n>:BITS	201
:BUS<n>:CLEar	203
:BUS<n>:DISPlay	204
:BUS<n>:LABel	205
:BUS<n>:MASK	206
:CALibrate Commands	207
:CALibrate:DATE	209
:CALibrate:LABel	210
:CALibrate:OUTPut	211
:CALibrate:STARt	212
:CALibrate:STATus	213
:CALibrate:SWITCh	214
:CALibrate:TEMPerature	215
:CALibrate:TIME	216
:CHANnel<n> Commands	217
:CHANnel<n>:BWLimit	220
:CHANnel<n>:COUPling	221
:CHANnel<n>:DISPlay	222
:CHANnel<n>:IMPedance	223
:CHANnel<n>:INVert	224
:CHANnel<n>:LABel	225
:CHANnel<n>:OFFSet	226
:CHANnel<n>:PROBe	227
:CHANnel<n>:PROBe:HEAD[:TYPE]	228
:CHANnel<n>:PROBe:ID	229
:CHANnel<n>:PROBe:SKEW	230
:CHANnel<n>:PROBe:STYPe	231
:CHANnel<n>:PROTection	232
:CHANnel<n>:RANGe	233

:CHANnel<n>:SCALE	234
:CHANnel<n>:UNITs	235
:CHANnel<n>:VERNier	236
:DIGital<n> Commands	237
:DIGital<n>:DISPlay	239
:DIGital<n>:LABel	240
:DIGital<n>:POSition	241
:DIGital<n>:SIZE	242
:DIGital<n>:THReshold	243
:DISPlay Commands	244
:DISPlay:CLEar	246
:DISPlay:DATA	247
:DISPlay:LABel	249
:DISPlay:LABList	250
:DISPlay:PERsistence	251
:DISPlay:SOURce	252
:DISPlay:VECTors	253
:EXTernal Trigger Commands	254
:EXTernal:BWLimit	256
:EXTernal:IMPedance	257
:EXTernal:PROBe	258
:EXTernal:PROBe:ID	259
:EXTernal:PROBe:STYPe	260
:EXTernal:PROTection	261
:EXTernal:RANGe	262
:EXTernal:UNITs	263
:FUNction Commands	264
:FUNction:CENTer	267
:FUNction:DISPlay	268
:FUNction:GOFT:OPERation	269
:FUNction:GOFT:SOURce1	270
:FUNction:GOFT:SOURce2	271
:FUNction:OFFSet	272
:FUNction:OPERation	273
:FUNction:RANGe	274
:FUNction:REFerence	275
:FUNction:SCALE	276
:FUNction:SOURce1	277
:FUNction:SOURce2	278
:FUNction:SPAN	279

:FUNction:WINDow	280
:HARDcopy Commands	281
:HARDcopy:AREA	283
:HARDcopy:APRinter	284
:HARDcopy:FACTors	285
:HARDcopy:FFEed	286
:HARDcopy:INKSaver	287
:HARDcopy:LAYout	288
:HARDcopy:PALette	289
:HARDcopy:PRINter:LIST	290
:HARDcopy:STARt	291
:LISTer Commands	292
:LISTer:DATA	293
:LISTer:DISPlay	294
:MARKer Commands	295
:MARKer:MODE	297
:MARKer:X1Position	298
:MARKer:X1Y1source	299
:MARKer:X2Position	300
:MARKer:X2Y2source	301
:MARKer:XDELta	302
:MARKer:Y1Position	303
:MARKer:Y2Position	304
:MARKer:YDELta	305
:MEASure Commands	306
:MEASure:CLEar	314
:MEASure:COUNter	315
:MEASure:DEFine	316
:MEASure:DELay	319
:MEASure:DUTYcycle	321
:MEASure:FALLtime	322
:MEASure:FREQuency	323
:MEASure:NWIDth	324
:MEASure:OVERshoot	325
:MEASure:PERiod	327
:MEASure:PHASe	328
:MEASure:PREShoot	329
:MEASure:PWIDth	330
:MEASure:RESults	331
:MEASure:RISetime	334

:MEASure:SDEVIation	335
:MEASure:SHOW	336
:MEASure:SOURce	337
:MEASure:STATistics	339
:MEASure:STATistics:INCRement	340
:MEASure:STATistics:RESet	341
:MEASure:TEDGE	342
:MEASure:TVALue	344
:MEASure:VAMPLitude	346
:MEASure:VAverage	347
:MEASure:VBASe	348
:MEASure:VMAX	349
:MEASure:VMIN	350
:MEASure:VPP	351
:MEASure:VRATio	352
:MEASure:VRMS	353
:MEASure:VTIME	354
:MEASure:VTOP	355
:MEASure:XMAX	356
:MEASure:XMIN	357
:MTESt Commands	358
:MTESt:AMASk:CREate	363
:MTESt:AMASk:SOURce	364
:MTESt:AMASk:UNITs	365
:MTESt:AMASk:XDELta	366
:MTESt:AMASk:YDELta	367
:MTESt:COUNt:FWAVEforms	368
:MTESt:COUNt:RESet	369
:MTESt:COUNt:TIME	370
:MTESt:COUNt:WAVEforms	371
:MTESt:DATA	372
:MTESt:DELeTe	373
:MTESt:ENABle	374
:MTESt:LOCK	375
:MTESt:OUTPut	376
:MTESt:RMODE	377
:MTESt:RMODE:FACTion:MEASure	378
:MTESt:RMODE:FACTion:PRINt	379
:MTESt:RMODE:FACTion:SAVE	380
:MTESt:RMODE:FACTion:STOP	381
:MTESt:RMODE:SIGMa	382

:MTESt:RMODe:TIME	383
:MTESt:RMODe:WAVeforms	384
:MTESt:SCALe:BIND	385
:MTESt:SCALe:X1	386
:MTESt:SCALe:XDELta	387
:MTESt:SCALe:Y1	388
:MTESt:SCALe:Y2	389
:MTESt:SOURce	390
:MTESt:TITLe	391
:POD Commands	392
:POD<n>:DISPlay	393
:POD<n>:SIZE	394
:POD<n>:THReshold	395
:RECall Commands	397
:RECall:FILename	398
:RECall:IMAGe[:STARt]	399
:RECall:MASK[:STARt]	400
:RECall:PWD	401
:RECall:SETup[:STARt]	402
:SAVE Commands	403
:SAVE:FILename	405
:SAVE:IMAGe[:STARt]	406
:SAVE:IMAGe:AREA	407
:SAVE:IMAGe:FACTors	408
:SAVE:IMAGe:FORMat	409
:SAVE:IMAGe:INKSaver	410
:SAVE:IMAGe:PALette	411
:SAVE:LISTer[:STARt]	412
:SAVE:MASK[:STARt]	413
:SAVE:PWD	414
:SAVE:SETup[:STARt]	415
:SAVE:WAVeform[:STARt]	416
:SAVE:WAVeform:FORMat	417
:SAVE:WAVeform:LENGth	418
:SAVE:WAVeform:SEGMENTed	419
:SBUS Commands	420
:SBUS:CAN:COUNT:ERRor	422
:SBUS:CAN:COUNT:OVERload	423
:SBUS:CAN:COUNT:RESet	424
:SBUS:CAN:COUNT:TOTal	425

:SBUS:CAN:COUNT:UTILization	426
:SBUS:DISPlay	427
:SBUS:FLEXray:COUNT:NULL	428
:SBUS:FLEXray:COUNT:RESet	429
:SBUS:FLEXray:COUNT:SYNC	430
:SBUS:FLEXray:COUNT:TOTal	431
:SBUS:I2S:BASE	432
:SBUS:IIC:ASIZe	433
:SBUS:LIN:PARity	434
:SBUS:M1553:BASE	435
:SBUS:MODE	436
:SBUS:SPI:BITorder	437
:SBUS:SPI:WIDTh	438
:SBUS:UART:BASE	439
:SBUS:UART:COUNT:ERRor	440
:SBUS:UART:COUNT:RESet	441
:SBUS:UART:COUNT:RXFRames	442
:SBUS:UART:COUNT:TXFRames	443
:SBUS:UART:FRAMing	444
:SYSTem Commands	445
:SYSTem:DATE	446
:SYSTem:DSP	447
:SYSTem:ERRor	448
:SYSTem:LOCK	449
:SYSTem:PRECIision	450
:SYSTem:PROTection:LOCK	451
:SYSTem:SETup	452
:SYSTem:TIME	454
:TIMebase Commands	455
:TIMebase:MODE	457
:TIMebase:POSIition	458
:TIMebase:RANGe	459
:TIMebase:REFClock	460
:TIMebase:REFerence	461
:TIMebase:SCALe	462
:TIMebase:VERNier	463
:TIMebase:WINDow:POSIition	464
:TIMebase:WINDow:RANGe	465
:TIMebase:WINDow:SCALe	466
:TRIGger Commands	467

General :TRIGger Commands	470
:TRIGger:HFReject	471
:TRIGger:HOLDoff	472
:TRIGger:MODE	473
:TRIGger:NREject	474
:TRIGger:PATtern	475
:TRIGger:SWEep	477
:TRIGger:CAN Commands	478
:TRIGger:CAN:PATtern:DATA	480
:TRIGger:CAN:PATtern:DATA:LENGth	481
:TRIGger:CAN:PATtern:ID	482
:TRIGger:CAN:PATtern:ID:MODE	483
:TRIGger:CAN:SAMPlepoint	484
:TRIGger:CAN:SIGNal:BAUDrate	485
:TRIGger:CAN:SOURce	486
:TRIGger:CAN:TRIGger	487
:TRIGger:DURation Commands	489
:TRIGger:DURation:GREaterthan	490
:TRIGger:DURation:LESSthan	491
:TRIGger:DURation:PATtern	492
:TRIGger:DURation:QUALifier	493
:TRIGger:DURation:RANGe	494
:TRIGger:EBURst Commands	495
:TRIGger:EBURst:COUNt	496
:TRIGger:EBURst:IDLE	497
:TRIGger:EBURst:SLOPe	498
:TRIGger[:EDGE] Commands	499
:TRIGger[:EDGE]:COUPling	500
:TRIGger[:EDGE]:LEVel	501
:TRIGger[:EDGE]:REJect	502
:TRIGger[:EDGE]:SLOPe	503
:TRIGger[:EDGE]:SOURce	504
:TRIGger:FLEXray Commands	505
:TRIGger:FLEXray:AUTOsetup	506
:TRIGger:FLEXray:BAUDrate	507
:TRIGger:FLEXray:CHANnel	508
:TRIGger:FLEXray:ERRor:TYPE	509
:TRIGger:FLEXray:EVENT:TYPE	510
:TRIGger:FLEXray:FRAME:CCBase	511
:TRIGger:FLEXray:FRAME:CCRepetition	512
:TRIGger:FLEXray:FRAME:ID	513
:TRIGger:FLEXray:FRAME:TYPE	514

:TRIGger:FLEXray:SOURce	515
:TRIGger:FLEXray:TRIGger	516
:TRIGger:GLITch Commands	517
:TRIGger:GLITch:GREaterthan	519
:TRIGger:GLITch:LESSthan	520
:TRIGger:GLITch:LEVel	521
:TRIGger:GLITch:POLarity	522
:TRIGger:GLITch:QUALifier	523
:TRIGger:GLITch:RANGe	524
:TRIGger:GLITch:SOURce	525
:TRIGger:I2S Commands	526
:TRIGger:I2S:ALIGNment	528
:TRIGger:I2S:AUDio	529
:TRIGger:I2S:CLOCK:SLOPe	530
:TRIGger:I2S:PATtern:DATA	531
:TRIGger:I2S:PATtern:FORMat	533
:TRIGger:I2S:RANGe	534
:TRIGger:I2S:RWIDth	536
:TRIGger:I2S:SOURce:CLOCK	537
:TRIGger:I2S:SOURce:DATA	538
:TRIGger:I2S:SOURce:WSElect	539
:TRIGger:I2S:TRIGger	540
:TRIGger:I2S:TWIDth	542
:TRIGger:I2S:WSLow	543
:TRIGger:IIC Commands	544
:TRIGger:IIC:PATtern:ADDRes	545
:TRIGger:IIC:PATtern:DATA	546
:TRIGger:IIC:PATtern:DATA2	547
:TRIGger:IIC[:SOURce]:CLOCK	548
:TRIGger:IIC[:SOURce]:DATA	549
:TRIGger:IIC:TRIGger:QUALifier	550
:TRIGger:IIC:TRIGger[:TYPE]	551
:TRIGger:LIN Commands	553
:TRIGger:LIN:ID	555
:TRIGger:LIN:PATtern:DATA	556
:TRIGger:LIN:PATtern:DATA:LENGth	558
:TRIGger:LIN:PATtern:FORMat	559
:TRIGger:LIN:SAMPlepoint	560
:TRIGger:LIN:SIGNal:BAUDrate	561
:TRIGger:LIN:SOURce	562
:TRIGger:LIN:STANdard	563
:TRIGger:LIN:SYNCbreak	564

:TRIGger:LIN:TRIGger	565
:TRIGger:M1553 Commands	566
:TRIGger:M1553:AUTosetup	567
:TRIGger:M1553:PATtern:DATA	568
:TRIGger:M1553:RTA	569
:TRIGger:M1553:SOURce:LOWer	570
:TRIGger:M1553:SOURce:UPPer	571
:TRIGger:M1553:TYPE	572
:TRIGger:SEQuence Commands	573
:TRIGger:SEQuence:COUNT	574
:TRIGger:SEQuence:EDGE	575
:TRIGger:SEQuence:FIND	576
:TRIGger:SEQuence:PATtern	577
:TRIGger:SEQuence:RESet	578
:TRIGger:SEQuence:TIMer	579
:TRIGger:SEQuence:TRIGger	580
:TRIGger:SPI Commands	581
:TRIGger:SPI:CLOCK:SLOPe	582
:TRIGger:SPI:CLOCK:TIMeout	583
:TRIGger:SPI:FRAMing	584
:TRIGger:SPI:PATtern:DATA	585
:TRIGger:SPI:PATtern:WIDTh	586
:TRIGger:SPI:SOURce:CLOCK	587
:TRIGger:SPI:SOURce:DATA	588
:TRIGger:SPI:SOURce:FRAMe	589
:TRIGger:TV Commands	590
:TRIGger:TV:LINE	591
:TRIGger:TV:MODE	592
:TRIGger:TV:POLarity	593
:TRIGger:TV:SOURce	594
:TRIGger:TV:STANdard	595
:TRIGger:UART Commands	596
:TRIGger:UART:BASE	598
:TRIGger:UART:BAUDrate	599
:TRIGger:UART:BITorder	600
:TRIGger:UART:BURSt	601
:TRIGger:UART:DATA	602
:TRIGger:UART:IDLE	603
:TRIGger:UART:PARity	604
:TRIGger:UART:POLarity	605
:TRIGger:UART:QUALifier	606
:TRIGger:UART:SOURce:RX	607

:TRIGger:UART:SOURce:TX	608
:TRIGger:UART:TYPE	609
:TRIGger:UART:WIDTh	610
:TRIGger:USB Commands	611
:TRIGger:USB:SOURce:DMINus	612
:TRIGger:USB:SOURce:DPLus	613
:TRIGger:USB:SPEed	614
:TRIGger:USB:TRIGger	615
:WAVeform Commands	616
:WAVeform:BYTeorder	624
:WAVeform:COUNt	625
:WAVeform:DATA	626
:WAVeform:FORMat	628
:WAVeform:POINts	629
:WAVeform:POINts:MODE	631
:WAVeform:PREamble	633
:WAVeform:SEGMented:COUNt	636
:WAVeform:SEGMented:TTAG	637
:WAVeform:SOURce	638
:WAVeform:SOURce:SUBSource	642
:WAVeform:TYPE	643
:WAVeform:UNSigned	644
:WAVeform:VIEW	645
:WAVeform:XINCrement	646
:WAVeform:XORigin	647
:WAVeform:XREFerence	648
:WAVeform:YINCrement	649
:WAVeform:YORigin	650
:WAVeform:YREFerence	651

6 Commands A-Z

7 Obsolete and Discontinued Commands

:CHANnel:ACTivity	693
:CHANnel:LABel	694
:CHANnel:THReshold	695
:CHANnel2:SKEW	696
:CHANnel<n>:INPut	697
:CHANnel<n>:PMODE	698
:DISPlay:CONNect	699
:DISPlay:ORDer	700

:ERASe 701
 :EXtErnal:INPut 702
 :EXtErnal:PMODE 703
 :FUNcTION:SOURce 704
 :FUNcTION:VIEW 705
 :HARDcopy:DEStination 706
 :HARDcopy:DEVice 707
 :HARDcopy:FILEname 708
 :HARDcopy:FORMat 709
 :HARDcopy:GRAYscale 710
 :HARDcopy:IGColors 711
 :HARDcopy:PDRIver 712
 :MEASure:LOWer 713
 :MEASure:SCRatch 714
 :MEASure:TDELta 715
 :MEASure:THResholds 716
 :MEASure:TMAX 717
 :MEASure:TMIN 718
 :MEASure:TStArt 719
 :MEASure:TStOp 720
 :MEASure:TVOLt 721
 :MEASure:UPPer 723
 :MEASure:VDELta 724
 :MEASure:VStArt 725
 :MEASure:VStOp 726
 :MTESt:AMASk:{SAVE | StORe} 727
 :MTESt:AVERage 728
 :MTESt:AVERage:COUNt 729
 :MTESt:LOAD 730
 :MTESt:RUMode 731
 :MTESt:RUMode:SOFailure 732
 :MTESt:{StARt | StOP} 733
 :MTESt:TRIGger:SOURce 734
 :PRINt? 735
 :TIMebase:DELay 737
 :TRIGger:CAN:ACKNowledge 738
 :TRIGger:CAN:SIGNal:DEFinition 739
 :TRIGger:LIN:SIGNal:DEFinition 740
 :TRIGger:THReshold 741
 :TRIGger:TV:TVMode 742

8 Error Messages

9 Status Reporting

Status Reporting Data Structures	754
Status Byte Register (STB)	757
Service Request Enable Register (SRE)	759
Trigger Event Register (TER)	760
Output Queue	761
Message Queue	762
(Standard) Event Status Register (ESR)	763
(Standard) Event Status Enable Register (ESE)	764
Error Queue	765
Operation Status Event Register (:OPERRegister[:EVENT])	766
Operation Status Condition Register (:OPERRegister:CONDition)	767
Arm Event Register (AER)	768
Overload Event Register (:OVLRegister)	769
Hardware Event Event Register (:HWERegister[:EVENT])	770
Hardware Event Condition Register (:HWERegister:CONDition)	771
Mask Test Event Event Register (:MTERegister[:EVENT])	772
Clearing Registers and Queues	773
Status Reporting Decision Chart	774

10 Synchronizing Acquisitions

Synchronization in the Programming Flow	776
Set Up the Oscilloscope	776
Acquire a Waveform	776
Retrieve Results	776
Blocking Synchronization	777
Polling Synchronization With Timeout	778
Synchronizing with a Single-Shot Device Under Test (DUT)	780
Synchronization with an Averaging Acquisition	782

11 More About Oscilloscope Commands

Command Classifications	786
Core Commands	786
Non-Core Commands	786
Obsolete Commands	786
Valid Command/Query Strings	787
Program Message Syntax	787
Command Tree	791
Duplicate Mnemonics	805
Tree Traversal Rules and Multiple Commands	806
Query Return Values	808
All Oscilloscope Commands Are Sequential	809

12 Programming Examples

VISA COM Examples	812
VISA COM Example in Visual Basic	812
VISA COM Example in C#	822
VISA COM Example in Visual Basic .NET	834
VISA Examples	845
VISA Example in C	845
VISA Example in Visual Basic	854
VISA Example in C#	864
VISA Example in Visual Basic .NET	877
SICL Examples	891
SICL Example in C	891
SICL Example in Visual Basic	900

Index

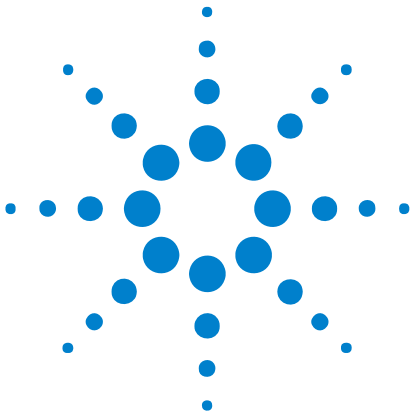

1 What's New

What's New in Version 6.00	22
What's New in Version 5.25	25
What's New in Version 5.20	27
What's New in Version 5.15	30
What's New in Version 5.10	32
Version 5.00 at Introduction	33



What's New in Version 6.00

New features in version 6.00 of the InfiniiVision 7000 Series oscilloscope software are:

- The ability to perform measurements and math functions on a 128K-point (maximum) precision analysis data record.
- Support for the new N5469A MIL-STD 1553 triggering and decode option (Option 553).
- Support for the new N5432C FlexRay triggering and decode option (Option FLX) which replaces previous FlexRay triggering and serial decode options.

More detailed descriptions of the new and changed commands appear below.

New Commands

Command	Description
:SBUS:M1553:BASE (see page 435)	Determines the base to use for the MIL-STD 1553 decode display.
:SBUS:SPI:BITorder (see page 437)	Selects the bit order used when displaying data in the SPI serial decode waveform and in the Lister.
:SYSTem:PRECision (see page 450)	Allows measurements and math functions to be performed on a <i>precision analysis record</i> (at the expense of waveform update rate).
:TRIGger:FLEXray:AUTOsetup (see page 506)	Performs automated oscilloscope setup for FlexRay triggering and decode.
:TRIGger:FLEXray:BAUDrate (see page 507)	Specifies the baud rate of the FlexRay signal.
:TRIGger:FLEXray:CHANnel (see page 508)	Specified whether the FlexRay input signal is for bus type A or B.
:TRIGger:FLEXray:SOURce (see page 515)	Specifies the input source channel probing the FlexRay signal.
:TRIGger:M1553 Commands (see page 566)	Commands for triggering on MIL-STD 1553 signals.

Changed Commands

Command	Differences
:SBUS:MODE (see page 436)	You can now select the M1553 serial bus decode mode.
:TRIGger:FLEXray:ERRor:TYPE (see page 509)	Now, only the FCRC, HCRC, or ALL error types can be selected.

Command	Differences
:TRIGger:FLEXray:EVENT:TYPE (see page 510)	The BSS (Byte Start Sequence) has been added and the FSS (Frame Start Sequence) has been removed.
:TRIGger:FLEXray:TRIGger (see page 516)	The TIME trigger type is no longer supported.
:TRIGger:MODE (see page 473)	You can now select the M1553 trigger mode.
:WAVEform:POINts (see page 631)	In the RAW or MAXimum waveform points modes, you can now specify 4,000,000 or 8,000,000 points in place of the previous 5,000,000 option.
:WAVEform:POINts:MODE (see page 631)	Command syntax is the same, but the NORMal mode returns: <ul style="list-style-type: none"> • The <i>measurement record</i> when :SYSTem:PRECision is OFF. • The <i>precision analysis record</i> when :SYSTem:PRECision is ON.

Discontinued Commands

Most of the following commands have been discontinued because they are not supported by the new N5432C FlexRay triggering and decode option (Option FLX) which replaces previous FlexRay triggering and serial decode options.

Discontinued Command	Current Command Equivalent	Comments
:DISPlay:FREeze	none	
:SBUS:BUSDoctor:ADDRes	none	The VPT1000 (BusDoctor) vehicle protocol tester module is not used with the new FLX option.
:SBUS:BUSDoctor:BAUDrate	none	The VPT1000 (BusDoctor) vehicle protocol tester module is not used with the new FLX option. You now specify the baud rate using the :TRIGger:FLEXray:BAUDrate (see page 507) command.
:SBUS:BUSDoctor:CHANnel	none	The VPT1000 (BusDoctor) vehicle protocol tester module is not used with the new FLX option. You now specify bus A or B using the :TRIGger:FLEXray:CHANnel (see page 508) command.

1 What's New

Discontinued Command	Current Command Equivalent	Comments
:SBUS:BUSDoctor:MODE	none	The VPT1000 (BusDoctor) vehicle protocol tester module is not used with the new FLX option.
:TRIGger:FLEXray:TIME:CBAS e	none	Time triggering not supported by new FLX option.
:TRIGger:FLEXray:TIME:CREPe tition	none	Time triggering not supported by new FLX option.
:TRIGger:FLEXray:TIME:SEGM ent	none	Time triggering not supported by new FLX option.
:TRIGger:FLEXray:TIME:SLOT	none	Time triggering not supported by new FLX option.
:TRIGger:FLEXray:EVENT:LEVel	none	The :TRIGger[:EDGE]:LEVel (see page 501) command is used instead, as with other trigger modes.
:TRIGger:FLEXray:EVENT:SOU Rce	none	The input source channels are now specified using the :TRIGger:FLEXray:SOURce (see page 515) command.

What's New in Version 5.25

New features in version 5.25 of the InfiniiVision 7000 Series oscilloscope software are:

- The Lister display for showing decoded serial data in tabular format.
- The ability to trigger on and decode I2S serial bus data with a four-channel oscilloscope that includes the Option SND license.
- FlexRay event triggering.

More detailed descriptions of the new and changed commands appear below.

New Commands

Command	Description
:CHANnel<n>:PROBe:HEAD[:TYPE] (see page 228)	Sets an analog channel probe head type and dB value.
:DISPlay:FREeze	Freezes the display without stopping currently running acquisitions.
:LISTer Commands (see page 292)	Commands for turning the Lister display on/off and for returning the Lister data.
:MTESt:RMODE:FACTion:MEASure (see page 378)	Lets you enable or disable measurements on mask test failures.
:SAVE:LISTer[:START] (see page 412)	Saves the Lister display data to a file.
:SBUS:I2S:BASE (see page 432)	Determines the base to use for the I2S decode display.
:TRIGger:FLEXray:EVENT:AUTOset	Automatically changes oscilloscope settings for the selected FlexRay event trigger type.
:TRIGger:FLEXray:EVENT:LEVel	Lets you fine-tune the voltage level for the FlexRay event trigger.
:TRIGger:FLEXray:EVENT:SOURce	Specifies the FlexRay event trigger source.
:TRIGger:FLEXray:EVENT:TYPE (see page 510)	Specifies the FlexRay event type to trigger on.
:TRIGger:I2S Commands (see page 526)	Commands for triggering on I2S signals.
:TRIGger:LIN:PATtern:DATA (see page 556)	Sets the data value when triggering on a LIN frame ID and data.
:TRIGger:LIN:PATtern:DATA:LENGth (see page 558)	Sets the byte length of the LIN data string.
:TRIGger:LIN:PATtern:FORMat (see page 559)	Sets the entry (and query) number base used by the :TRIGger:LIN:PATtern:DATA command.

1 What's New

Changed Commands

Command	Differences
:SBUS:MODE (see page 436)	You can now select the I2S serial bus decode mode.
:TRIGger:FLEXray:TRIGger (see page 516)	You can now select FlexRay EVENT triggers.
:TRIGger:LIN:TRIGger (see page 565)	You can now select the DATA option for triggering on a LIN frame ID and data.
:TRIGger:MODE (see page 473)	You can now select the I2S trigger mode.
:TRIGger:TV:STANdard (see page 595)	The P1080L50HZ and P1080L60HZ standards have been added.

What's New in Version 5.20

New features in version 5.20 of the InfiniiVision 7000 Series oscilloscope software are:

- Mask testing, enabled with Option LMT.
- Tracking cursors (markers) have been added.
- Measurement statistics have been added.
- Labels can now be up to 10 characters.

More detailed descriptions of the new and changed commands appear below.

New Commands

Command	Description
:ACQuire:SEGmented:ANALyze (see page 190)	Calculates measurement statistics and/or infinite persistence over all segments that have been acquired.
:CALibrate:OUTPut (see page 211)	Selects the signal output on the rear panel TRIG OUT BNC.
:HARDcopy:LAYout (see page 288)	Sets the hardcopy layout mode.
:MEASure:RESults (see page 331)	Returns measurement statistics values.
:MEASure:STATistics (see page 339)	Sets the type of measurement statistics to return.
:MEASure:STATistics:INCRement (see page 340)	Updates the statistics once (incrementing the count by one) using the current measurement values.
:MEASure:STATistics:RESet (see page 341)	Resets the measurement statistics values.
:MTEenable (Mask Test Event Enable Register) (see page 159)	Sets a mask in the Mask Test Event Enable register.
:MTEregister[:EVENT] (Mask Test Event Event Register) (see page 161)	Returns the integer value contained in the Mask Test Event Event Register and clears the register.
:MTESt Commands (see page 358)	Commands and queries to control the mask test (Option LMT) features.
:RECall:MASK[:START] (see page 413)	Recalls a mask.
:SAVE:MASK[:START] (see page 413)	Saves the current mask.
:SAVE:WAVEform:SEGmented (see page 419)	Specifies which segments are included when the waveform is saved.
:TRIGger:UART:BASE (see page 598)	Selects the front panel UART/RS232 trigger setup data selection option from HEX or BINary.

Changed Commands

Command	Differences
:BUS<n>:LABel (see page 205)	Labels can now be up to 10 characters.
:CHANnel<n>:LABel (see page 225)	Labels can now be up to 10 characters.
:DIGital<n>:LABel (see page 240)	Labels can now be up to 10 characters.
:DISPlay:LABList (see page 250)	Labels can now be up to 10 characters.
:MARKer:MODE (see page 297)	You can now select the WAVeform tracking cursors mode.
:RECall:PWD (see page 401)	You can set the present working directory in addition to querying for this information.
:SAVE:IMAGe[:START] (see page 406)	The file extension specified will change the :SAVE:IMAGe:FORMat setting if it is a valid image file extension.
:SAVE:PWD (see page 414)	You can set the present working directory in addition to querying for this information.
:SAVE:WAVeform[:START] (see page 406)	The file extension specified will change the :SAVE:WAVeform:FORMat setting if it is a valid waveform file extension.
:TRIGger:CAN:SIGNal:BAUDrate (see page 485)	The baud rate value can now be set in 100 b/s increments.
:TRIGger:LIN:SIGNal:BAUDrate (see page 561)	The baud rate value can now be set in 100 b/s increments.
:TRIGger:UART:BAUDrate (see page 599)	The baud rate value can now be set in 100 b/s increments and the maximum baud rate is now 3 Mb/s.
:TRIGger:UART:DATA (see page 602)	You can now specify the data value using a quoted ASCII character.

Obsolete Commands

Obsolete Command	Current Command Equivalent	Behavior Differences
:MTESt:AMASK:{SAVE STORE} (see page 727)	:SAVE:MASK[:START] (see page 413)	
:MTESt:AVERage (see page 728)	:ACQuire:TYPE AVERage (see page 196)	
:MTESt:AVERage:COUNT (see page 729)	:ACQuire:COUNT (see page 185)	
:MTESt:LOAD (see page 730)	:RECall:MASK[:START] (see page 400)	
:MTESt:RUMode (see page 731)	:MTESt:RMODE (see page 377)	

Obsolete Command	Current Command Equivalent	Behavior Differences
:MTESt:RUMode:SOFailure (see page 732)	:MTESt:RMODE:FACTion:STOP (see page 381)	
:MTESt:{START STOP} (see page 733)	:RUN (see page 174) or :STOP (see page 178)	
:MTESt:TRIGger:SOURce (see page 734)	:TRIGger Commands (see page 467)	There are various commands for setting the source with different types of triggers.

What's New in Version 5.15

New features in version 5.15 of the InfiniiVision 7000 Series oscilloscope software are:

- Waveform math can be performed using channels 3 and 4, and there is a new ADD operator.
- Ratio of AC RMS values measurement.
- Analog channel impedance protection lock.

More detailed descriptions of the new and changed commands appear below.

New Commands

Command	Description
:FUNction:GOFT:OPERation (see page 269)	Selects the math operation for the internal g(t) source that can be used as the input to the FFT, INTegrate, DIFFerentiate, and SQRT functions.
:FUNction:GOFT:SOURce1 (see page 270)	Selects the first input channel for the g(t) source.
:FUNction:GOFT:SOURce2 (see page 271)	Selects the second input channel for the g(t) source.
:FUNction:SOURce1 (see page 277)	Selects the first source for the ADD, SUBTract, and MULTiPLY arithmetic operations or the single source for the FFT, INTegrate, DIFFerentiate, and SQRT functions.
:FUNction:SOURce2 (see page 278)	Selects the second input channel for the ADD, SUBTract, and MULTiPLY arithmetic operations.
:MEASure:VRATio (see page 352)	Measures and returns the ratio of AC RMS values of the specified sources expressed in dB.
:SYSTem:PROTection:LOCK (see page 451)	Disables/enables the fifty ohm input impedance setting.

Changed Commands

Command	Differences
:ACQuire:COUNt (see page 185)	The :ACQuire:COUNt 1 command has been deprecated. The AVERage acquisition type with a count of 1 is functionally equivalent to the HRESolution acquisition type; however, you should select the high-resolution acquisition mode with the :ACQuire:TYPE HRESolution command instead.
:FUNction:OPERation (see page 273)	The ADD parameter is new, and now that waveform math can be performed using channels 3 and 4, this command selects the operation only.
:FUNction:WINDow (see page 280)	You can now select the Blackman-Harris FFT window.

Obsolete Commands

Obsolete Command	Current Command Equivalent	Behavior Differences
:FUNction:SOURce (see page 704)	:FUNction:SOURce1 (see page 277)	Obsolete command has ADD, SUBTract, and MULTIpLy parameters; current command has GOFT parameter.

What's New in Version 5.10

New features in version 5.10 of the InfiniiVision 7000 Series oscilloscope software are:

- Segmented memory acquisition mode, enabled with Option SGM.

More detailed descriptions of the new and changed commands appear below.

New Commands

Command	Description
:ACQuire:SEGMented:COUNT (see page 191)	Sets the number of memory segments.
:ACQuire:SEGMented:INDEX (see page 192)	Selects the segmented memory index.
:WAVEform:SEGMented:COUNT (see page 636)	Returns the number of segments in the currently acquired waveform data.
:WAVEform:SEGMented:TTAG (see page 637)	Returns the time tag for the selected segmented memory index.

Changed Commands

Command	Differences
:ACQuire:MODE (see page 187)	You can now select the SEGMented memory mode.

Version 5.00 at Introduction

The Agilent InfiniiVision 7000 Series oscilloscopes were introduced with version 5.00 of oscilloscope operating software. The command set is based on the 6000 Series oscilloscopes (and the 54620/54640 Series oscilloscopes before them).

1 What's New

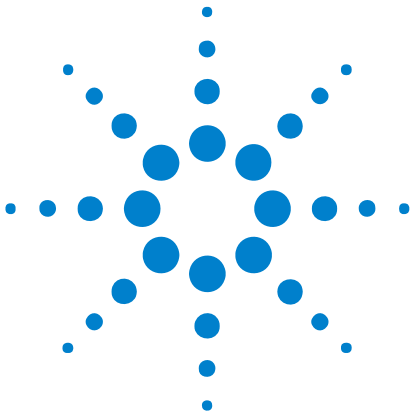

2 Setting Up

- Step 1. Install Agilent IO Libraries Suite software [36](#)
- Step 2. Connect and set up the oscilloscope [37](#)
- Step 3. Verify the oscilloscope connection [39](#)

This chapter explains how to install the Agilent IO Libraries Suite software, connect the oscilloscope to the controller PC, set up the oscilloscope, and verify the oscilloscope connection.



Step 1. Install Agilent IO Libraries Suite software

Insert the Automation-Ready CD that was shipped with your oscilloscope into the controller PC's CD-ROM drive, and follow its installation instructions.

You can also download the Agilent IO Libraries Suite software from the web at:

- "<http://www.agilent.com/find/iolib>"

Step 2. Connect and set up the oscilloscope

The 7000 Series oscilloscope has two different interfaces you can use for programming: USB (device) or LAN.

Both interfaces are "live" by default, but you can turn them off if desired. To access these settings press the **Utility** key on the front panel, then press the **I/O** softkey, then press the **Control** softkey.

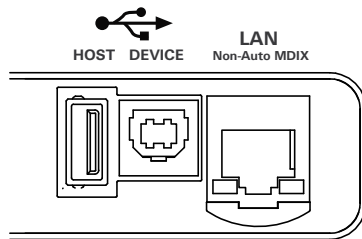

Figure 1 Control Connectors on Rear Panel

Using the USB (Device) Interface

- 1 Connect a USB cable from the controller PC's USB port to the "USB DEVICE" port on the back of the oscilloscope.

This is a USB 2.0 high-speed port.

- 2 On the oscilloscope, verify that the controller interface is enabled:
 - a Press the **Utility** button.
 - b Using the softkeys, press **I/O** and **Control**.
 - c Ensure the box next to **USB** is selected (). If not () , use the Entry knob to select **USB**; then, press the **Control** softkey again.

Using the LAN Interface

- 1 If the controller PC isn't already connected to the local area network (LAN), do that first.
- 2 Get the oscilloscope's network parameters (hostname, domain, IP address, subnet mask, gateway IP, DNS IP, etc.) from your network administrator.
- 3 Connect the oscilloscope to the local area network (LAN) by inserting LAN cable into the "LAN" port on the back of the oscilloscope.

- 4 On the oscilloscope, verify that the controller interface is enabled:
 - a Press the **Utility** button.
 - b Using the softkeys, press **I/O** and **Control**.
 - c Ensure the box next to **LAN** is selected (■). If not (□), use the Entry knob to select **LAN**; then, press the **Control** softkey again.
- 5 Configure the oscilloscope's LAN interface:
 - a Press the **Configure** softkey until "LAN" is selected.
 - b Press the **LAN Settings** softkey.
 - c Press the **Addresses** softkey. Use the **IP Options** softkey and the Entry knob to select DHCP, AutoIP, or netBIOS. Use the **Modify** softkey (and the other softkeys and the Entry knob) to enter the IP Address, Subnet Mask, Gateway IP, and DNS IP values. When you are done, press the return (up arrow) softkey.
 - d Press the **Domain** softkey. Use the **Modify** softkey (and the other softkeys and the Entry knob) to enter the Host name and the Domain name. When you are done, press the return (up arrow) softkey.

Step 3. Verify the oscilloscope connection

- 1 On the controller PC, click on the Agilent IO Control icon in the taskbar and choose **Agilent Connection Expert** from the popup menu.

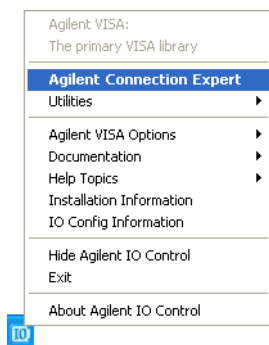

- 2 In the Agilent Connection Expert application, instruments connected to the controller's USB and GPIB interfaces should automatically appear. (You can click Refresh All to update the list of instruments on these interfaces.)

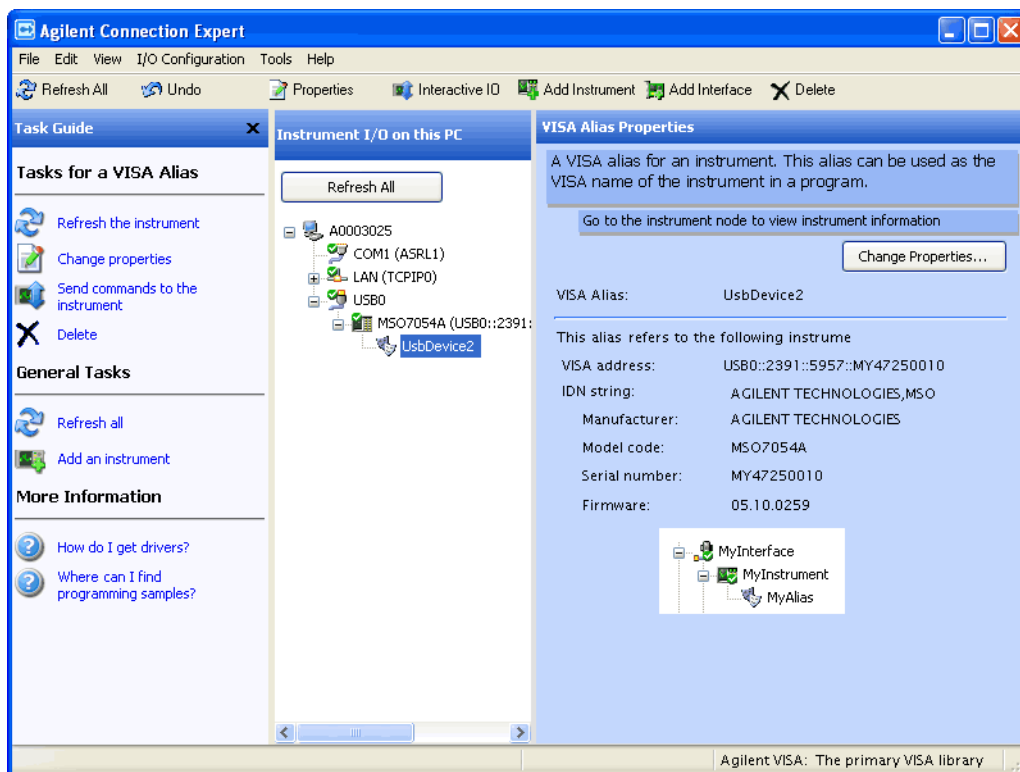

2 Setting Up

You must manually add instruments on LAN interfaces:

- a Right-click on the LAN interface, choose **Add Instrument** from the popup menu

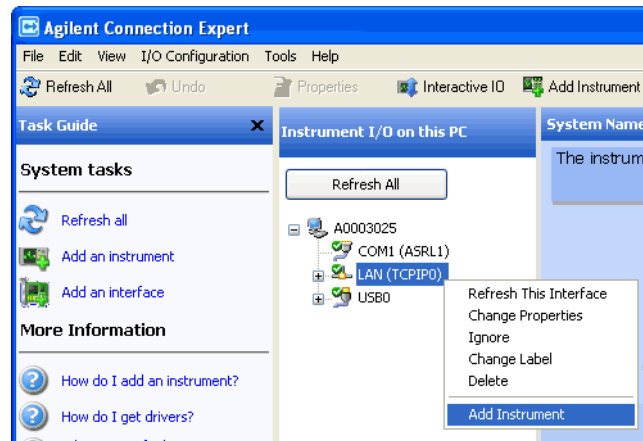

- b If the oscilloscope is on the same subnet, select it, and click **OK**.

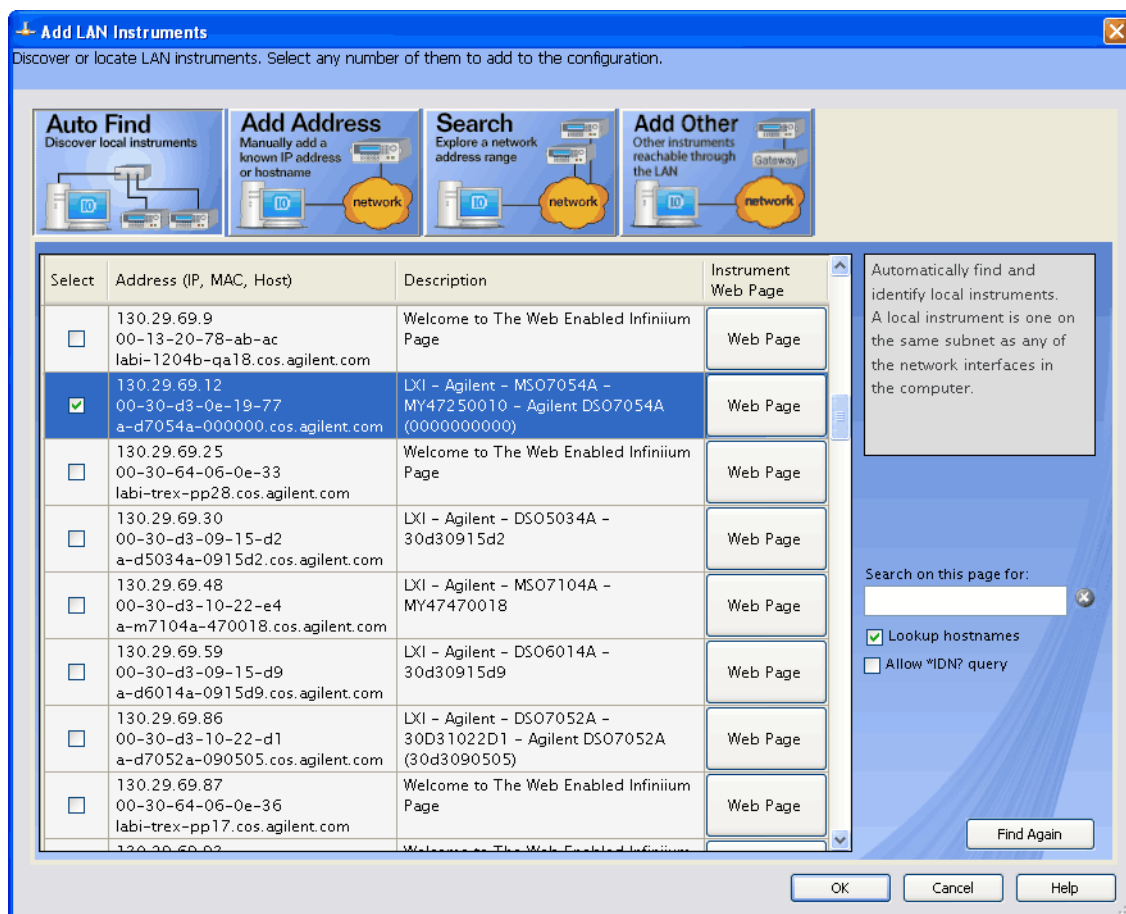

Otherwise, if the instrument is not on the same subnet, click **Add Address**.

- i In the next dialog, select either **Hostname** or **IP address**, and enter the oscilloscope's hostname or IP address.
- ii Click **Test Connection**.

2 Setting Up

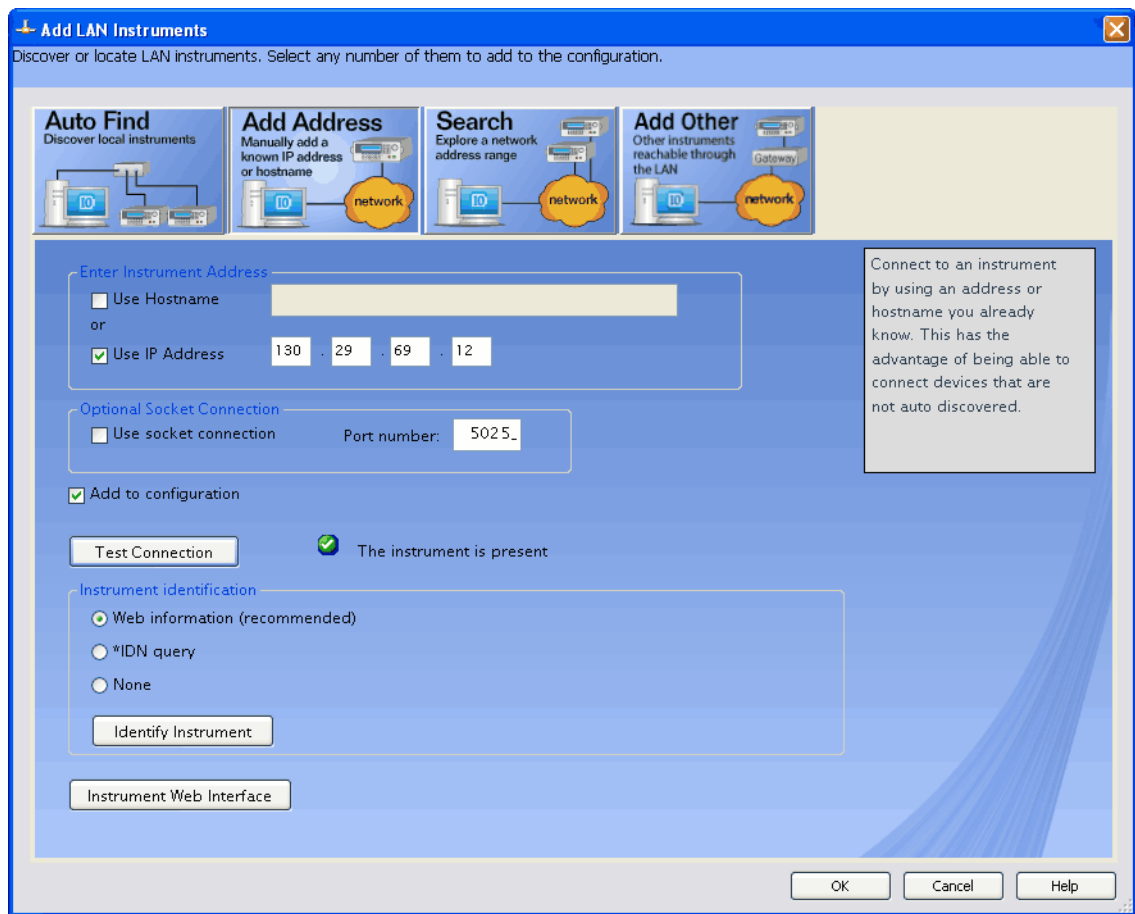

- iii If the instrument is successfully opened, click **OK** to close the dialog. If the instrument is not opened successfully, go back and verify the LAN connections and the oscilloscope setup.

- 3 Test some commands on the instrument:
 - a Right-click on the instrument and choose **Send Commands To This Instrument** from the popup menu.

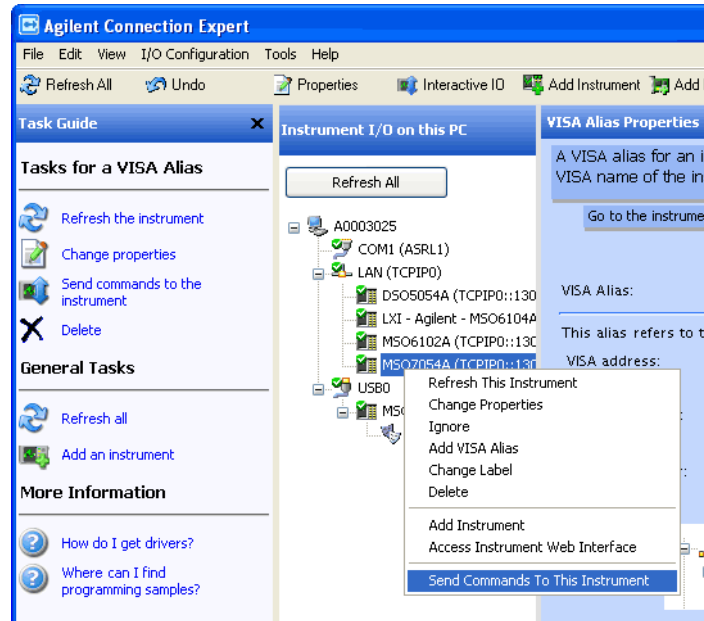

- b In the Agilent Interactive IO application, enter commands in the **Command** field and press **Send Command**, **Read Response**, or **Send&Read**.

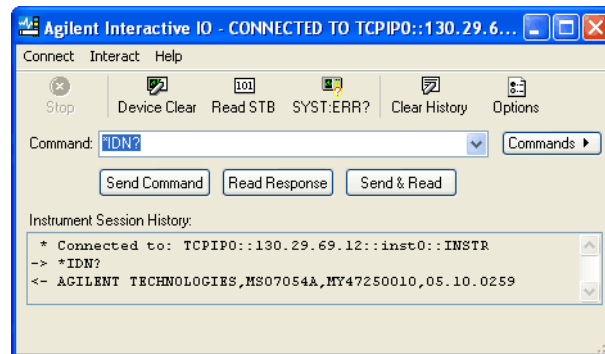

- c Choose **Connect>Exit** from the menu to exit the Agilent Interactive IO application.
- 4 In the Agilent Connection Expert application, choose **File>Exit** from the menu to exit the application.

2 Setting Up

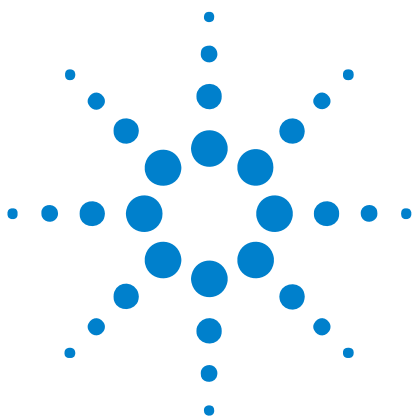

3 Getting Started

Basic Oscilloscope Program Structure	46
Programming the Oscilloscope	48
Other Ways of Sending Commands	57

This chapter gives you an overview of programming the 7000 Series oscilloscopes. It describes basic oscilloscope program structure and shows how to program the oscilloscope using a few simple examples.

The getting started examples show how to send oscilloscope setup, data capture, and query commands, and they show how to read query results.

NOTE

Language for Program Examples

The programming examples in this guide are written in Visual Basic using the Agilent VISA COM library.



Basic Oscilloscope Program Structure

The following figure shows the basic structure of every program you will write for the oscilloscope.

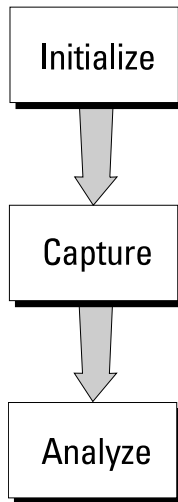

Initializing

To ensure consistent, repeatable performance, you need to start the program, controller, and oscilloscope in a known state. Without correct initialization, your program may run correctly in one instance and not in another. This might be due to changes made in configuration by previous program runs or from the front panel of the oscilloscope.

- Program initialization defines and initializes variables, allocates memory, or tests system configuration.
- Controller initialization ensures that the interface to the oscilloscope is properly set up and ready for data transfer.
- Oscilloscope initialization sets the channel configuration, channel labels, threshold voltages, trigger specification, trigger mode, timebase, and acquisition type.

Capturing Data

Once you initialize the oscilloscope, you can begin capturing data for analysis. Remember that while the oscilloscope is responding to commands from the controller, it is not performing acquisitions. Also, when you change the oscilloscope configuration, any data already captured will most likely be rendered.

To collect data, you use the `:DIGitize` command. This command clears the waveform buffers and starts the acquisition process. Acquisition continues until acquisition memory is full, then stops. The acquired data is displayed by the oscilloscope, and the captured data can be measured, stored in trace memory in the oscilloscope, or transferred to the controller for further analysis. Any additional commands sent while `:DIGitize` is working are buffered until `:DIGitize` is complete.

You could also put the oscilloscope into run mode, then use a wait loop in your program to ensure that the oscilloscope has completed at least one acquisition before you make a measurement. Agilent does not recommend this because the needed length of the wait loop may vary, causing your program to fail. `:DIGitize`, on the other hand, ensures that data capture is complete. Also, `:DIGitize`, when complete, stops the acquisition process so that all measurements are on displayed data, not on a constantly changing data set.

Analyzing Captured Data

After the oscilloscope has completed an acquisition, you can find out more about the data, either by using the oscilloscope measurements or by transferring the data to the controller for manipulation by your program. Built-in measurements include: frequency, duty cycle, period, positive pulse width, and negative pulse width.

Using the `:WAVEform` commands, you can transfer the data to your controller. You may want to display the data, compare it to a known good measurement, or simply check logic patterns at various time intervals in the acquisition.

Programming the Oscilloscope

- "Referencing the IO Library" on page 48
- "Opening the Oscilloscope Connection via the IO Library" on page 49
- "Using :AUToscale to Automate Oscilloscope Setup" on page 50
- "Using Other Oscilloscope Setup Commands" on page 50
- "Capturing Data with the :DIGitize Command" on page 51
- "Reading Query Responses from the Oscilloscope" on page 53
- "Reading Query Results into String Variables" on page 54
- "Reading Query Results into Numeric Variables" on page 54
- "Reading Definite-Length Block Query Response Data" on page 54
- "Sending Multiple Queries and Reading Results" on page 55
- "Checking Instrument Status" on page 56

Referencing the IO Library

No matter which instrument programming library you use (SICL, VISA, or VISA COM), you must reference the library from your program.

In C/C++, you must tell the compiler where to find the include and library files (see the Agilent IO Libraries Suite documentation for more information).

To reference the Agilent VISA COM library in Visual Basic for Applications (VBA, which comes with Microsoft Office products like Excel):

- 1 Choose **Tools>References...** from the main menu.
- 2 In the References dialog, check the "VISA COM 3.0 Type Library".

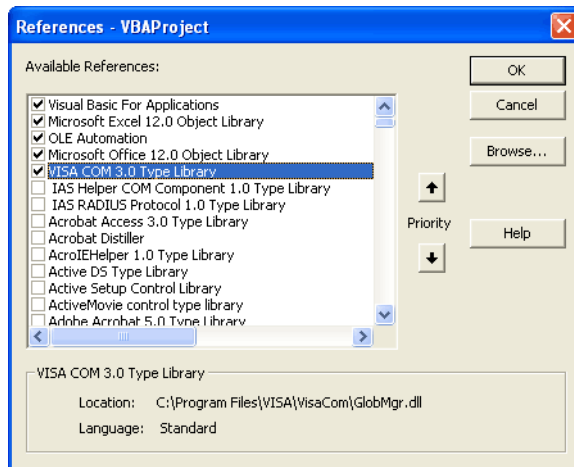

3 Click **OK**.

To reference the Agilent VISA COM library in Microsoft Visual Basic 6.0:

1 Choose **Project>References...** from the main menu.

2 In the References dialog, check the "VISA COM 3.0 Type Library".

3 Click **OK**.

Opening the Oscilloscope Connection via the IO Library

PC controllers communicate with the oscilloscope by sending and receiving messages over a remote interface. Once you have opened a connection to the oscilloscope over the remote interface, programming instructions normally appear as ASCII character strings embedded inside write statements of the programming language. Read statements are used to read query responses from the oscilloscope.

For example, when using the Agilent VISA COM library in Visual Basic (after opening the connection to the instrument using the ResourceManager object's Open method), the FormattedIO488 object's WriteString, WriteNumber, WriteList, or WriteIEEEBlock methods are used for sending commands and queries. After a query is sent, the response is read using the ReadString, ReadNumber, ReadList, or ReadIEEEBlock methods.

The following Visual Basic statements open the connection and send a command that turns on the oscilloscope's label display.

```
Dim myMgr As VisaComLib.ResourceManager
Dim myScope As VisaComLib.FormattedIO488

Set myMgr = New VisaComLib.ResourceManager
Set myScope = New VisaComLib.FormattedIO488

' Open the connection to the oscilloscope. Get the VISA Address from the
' Agilent Connection Expert (installed with Agilent IO Libraries Suite).
Set myScope.IO = myMgr.Open("<VISA Address>")

' Send a command.
myScope.WriteString ":DISPlay:LABel ON"
```

The ":DISPLAY:LABEL ON" in the above example is called a *program message*. Program messages are explained in more detail in "[Program Message Syntax](#)" on page 787.

Initializing the Interface and the Oscilloscope

To make sure the bus and all appropriate interfaces are in a known state, begin every program with an initialization statement. When using the Agilent VISA COM library, you can use the resource session object's Clear method to clear the interface buffer:

```
Dim myMgr As VisaComLib.ResourceManager
Dim myScope As VisaComLib.FormattedIO488

Set myMgr = New VisaComLib.ResourceManager
Set myScope = New VisaComLib.FormattedIO488

' Open the connection to the oscilloscope. Get the VISA Address from the
' Agilent Connection Expert (installed with Agilent IO Libraries Suite).
Set myScope.IO = myMgr.Open("<VISA Address>")

' Clear the interface buffer.
myScope.IO.Clear
```

When you are using GPIB, CLEAR also resets the oscilloscope's parser. The parser is the program which reads in the instructions which you send it.

After clearing the interface, initialize the instrument to a preset state:

```
myScope.WriteString "*RST"
```

NOTE

Information for Initializing the Instrument

The actual commands and syntax for initializing the instrument are discussed in "[Common \(*\) Commands](#)" on page 113.

Refer to the Agilent IO Libraries Suite documentation for information on initializing the interface.

Using :AUToscale to Automate Oscilloscope Setup

The :AUToscale command performs a very useful function for unknown waveforms by setting up the vertical channel, time base, and trigger level of the instrument.

The syntax for the autoscale command is:

```
myScope.WriteString ":AUToscale"
```

Using Other Oscilloscope Setup Commands

A typical oscilloscope setup would set the vertical range and offset voltage, the horizontal range, delay time, delay reference, trigger mode, trigger level, and slope. An example of the commands that might be sent to the oscilloscope are:

```
myScope.WriteString ":CHANnel1:PROBe 10"
myScope.WriteString ":CHANnel1:RANGe 16"
myScope.WriteString ":CHANnel1:OFFSet 1.00"
myScope.WriteString ":TIMEbase:MODE MAIN"
myScope.WriteString ":TIMEbase:RANGe 1E-3"
myScope.WriteString ":TIMEbase:DELay 100E-6"
```

Vertical is set to 16 V full-scale (2 V/div) with center of screen at 1 V and probe attenuation set to 10. This example sets the time base at 1 ms full-scale (100 ms/div) with a delay of 100 μ s.

Example Oscilloscope Setup Code

This program demonstrates the basic command structure used to program the oscilloscope.

```
' Initialize the instrument interface to a known state.
myScope.IO.Clear

' Initialize the instrument to a preset state.
myScope.WriteString "*RST"

' Set the time base mode to normal with the horizontal time at
' 50 ms/div with 0 s of delay referenced at the center of the
' graticule.
myScope.WriteString ":TIMEbase:RANGe 5E-4" ' Time base to 50 us/div.
myScope.WriteString ":TIMEbase:DELay 0" ' Delay to zero.
myScope.WriteString ":TIMEbase:REFerence CENTER" ' Display ref. at
' center.

' Set the vertical range to 1.6 volts full scale with center screen
' at -0.4 volts with 10:1 probe attenuation and DC coupling.
myScope.WriteString ":CHANnel:PROBE 10" ' Probe attenuation
' to 10:1.
myScope.WriteString ":CHANnel:RANGe 1.6" ' Vertical range
' 1.6 V full scale.
myScope.WriteString ":CHANnel:OFFSet -.4" ' Offset to -0.4.
myScope.WriteString ":CHANnel:COUPLing DC" ' Coupling to DC.

' Configure the instrument to trigger at -0.4 volts with normal
' triggering.
myScope.WriteString ":TRIGger:SWEep NORMal" ' Normal triggering.
myScope.WriteString ":TRIGger:LEVel -.4" ' Trigger level to -0.4.
myScope.WriteString ":TRIGger:SLOPe POSitive" ' Trigger on pos. slope.

' Configure the instrument for normal acquisition.
myScope.WriteString ":ACQuire:TYPE NORMal" ' Normal acquisition.
```

Capturing Data with the :DIGitize Command

The :DIGitize command captures data that meets the specifications set up by the :ACquire subsystem. When the digitize process is complete, the acquisition is stopped. The captured data can then be measured by the instrument or transferred to the controller for further analysis. The captured data consists of two parts: the waveform data record, and the preamble.

NOTE**Ensure New Data is Collected**

When you change the oscilloscope configuration, the waveform buffers are cleared. Before doing a measurement, send the :DIGitize command to the oscilloscope to ensure new data has been collected.

When you send the :DIGitize command to the oscilloscope, the specified channel signal is digitized with the current :ACQUIRE parameters. To obtain waveform data, you must specify the :WAVEFORM parameters for the SOURCE channel, the FORMAT type, and the number of POINTs prior to sending the :WAVEFORM:DATA? query.

NOTE**Set :TIMEbase:MODE to MAIN when using :DIGitize**

:TIMEbase:MODE must be set to MAIN to perform a :DIGitize command or to perform any :WAVEFORM subsystem query. A "Settings conflict" error message will be returned if these commands are executed when MODE is set to ROLL, XY, or WINDOW (zoomed). Sending the *RST (reset) command will also set the time base mode to normal.

The number of data points comprising a waveform varies according to the number requested in the :ACQUIRE subsystem. The :ACQUIRE subsystem determines the number of data points, type of acquisition, and number of averages used by the :DIGitize command. This allows you to specify exactly what the digitized information contains.

The following program example shows a typical setup:

```
myScope.WriteString ":ACQUIRE:TYPE AVERage"  
myScope.WriteString ":ACQUIRE:COMPLETE 100"  
myScope.WriteString ":ACQUIRE:COUNT 8"  
myScope.WriteString ":DIGitize CHANNEL1"  
myScope.WriteString ":WAVEFORM:SOURCE CHANNEL1"  
myScope.WriteString ":WAVEFORM:FORMAT BYTE"  
myScope.WriteString ":WAVEFORM:POINTS 500"  
myScope.WriteString ":WAVEFORM:DATA?"
```

This setup places the instrument into the averaged mode with eight averages. This means that when the :DIGitize command is received, the command will execute until the signal has been averaged at least eight times.

After receiving the :WAVEFORM:DATA? query, the instrument will start passing the waveform information.

Digitized waveforms are passed from the instrument to the controller by sending a numerical representation of each digitized point. The format of the numerical representation is controlled with the :WAVEFORM:FORMAT command and may be selected as BYTE, WORD, or ASCII.

The easiest method of transferring a digitized waveform depends on data structures, formatting available and I/O capabilities. You must scale the integers to determine the voltage value of each point. These integers are passed starting with the left most point on the instrument's display.

For more information, see the waveform subsystem commands and corresponding program code examples in "[:WAVEform Commands](#)" on page 616.

NOTE**Aborting a Digitize Operation Over the Programming Interface**

When using the programming interface, you can abort a digitize operation by sending a Device Clear over the bus (for example, `myScope.IO.Clear`).

Reading Query Responses from the Oscilloscope

After receiving a query (command header followed by a question mark), the instrument interrogates the requested function and places the answer in its output queue. The answer remains in the output queue until it is read or another command is issued. When read, the answer is transmitted across the interface to the designated listener (typically a controller).

The statement for reading a query response message from an instrument's output queue typically has a format specification for handling the response message.

When using the VISA COM library in Visual Basic, you use different read methods (`ReadString`, `ReadNumber`, `ReadList`, or `ReadIEEEBlock`) for the various query response formats. For example, to read the result of the query command `:CHANnel1:COUPling?` you would execute the statements:

```
myScope.WriteString ":CHANnel1:COUPling?"
Dim strQueryResult As String
strQueryResult = myScope.ReadString
```

This reads the current setting for the channel one coupling into the string variable `strQueryResult`.

All results for queries (sent in one program message) must be read before another program message is sent.

Sending another command before reading the result of the query clears the output buffer and the current response. This also causes an error to be placed in the error queue.

Executing a read statement before sending a query causes the controller to wait indefinitely.

The format specification for handling response messages depends on the programming language.

Reading Query Results into String Variables

The output of the instrument may be numeric or character data depending on what is queried. Refer to the specific command descriptions in [Chapter 5](#), “Commands by Subsystem,” starting on page 111 for the formats and types of data returned from queries.

NOTE

Express String Variables Using Exact Syntax

In Visual Basic, string variables are case sensitive and must be expressed exactly the same each time they are used.

The following example shows numeric data being returned to a string variable:

```
myScope.WriteString ":CHANnel1:RANGe?"
Dim strQueryResult As String
strQueryResult = myScope.ReadString
MsgBox "Range (string):" + strQueryResult
```

After running this program, the controller displays:

Range (string): +40.0E+00

Reading Query Results into Numeric Variables

The following example shows numeric data being returned to a numeric variable:

```
myScope.WriteString ":CHANnel1:RANGe?"
Dim varQueryResult As Variant
strQueryResult = myScope.ReadNumber
MsgBox "Range (variant):" + CStr(varQueryResult)
```

After running this program, the controller displays:

Range (variant): 40

Reading Definite-Length Block Query Response Data

Definite-length block query response data allows any type of device-dependent data to be transmitted over the system interface as a series of 8-bit binary data bytes. This is particularly useful for sending large quantities of data or 8-bit extended ASCII codes. The syntax is a pound sign (#) followed by a non-zero digit representing the number of digits in the decimal integer. After the non-zero digit is the decimal integer that states the number of 8-bit data bytes being sent. This is followed by the actual data.

For example, for transmitting 1000 bytes of data, the syntax would be:

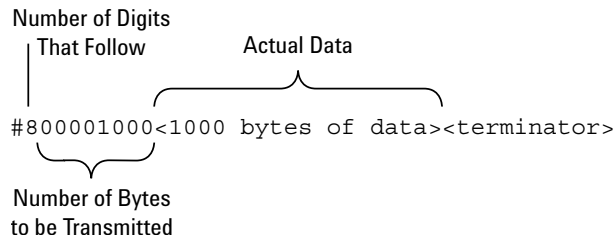

Figure 2 Definite-length block response data

The "8" states the number of digits that follow, and "00001000" states the number of bytes to be transmitted.

The VISA COM library's `ReadIEEEBlock` and `WriteIEEEBlock` methods understand the definite-length block syntax, so you can simply use variables that contain the data:

```
' Read oscilloscope setup using ":SYSTEM:SETup?" query.
myScope.WriteString ":SYSTEM:SETup?"
Dim varQueryResult As Variant
varQueryResult = myScope.ReadIEEEBlock(BinaryType_UI1)

' Write learn string back to oscilloscope using ":SYSTEM:SETup" command:
myScope.WriteIEEEBlock ":SYSTEM:SETup ", varQueryResult
```

Sending Multiple Queries and Reading Results

You can send multiple queries to the instrument within a single command string, but you must also read them back as a single query result. This can be accomplished by reading them back into a single string variable, multiple string variables, or multiple numeric variables.

For example, to read the `:TIMEbase:RANGE?;DElay?` query result into a single string variable, you could use the commands:

```
myScope.WriteString ":TIMEbase:RANGE?;DElay?"
Dim strQueryResult As String
strQueryResult = myScope.ReadString
MsgBox "Timebase range; delay:" + strQueryResult
```

When you read the result of multiple queries into a single string variable, each response is separated by a semicolon. For example, the output of the previous example would be:

```
Timebase range; delay: <range_value>;<delay_value>
```

To read the `:TIMEbase:RANGE?;DElay?` query result into multiple string variables, you could use the `ReadList` method to read the query results into a string array variable using the commands:

```
myScope.WriteString ":TIMEbase:RANGE?;DElay?"
Dim strResults() As String
```

```
strResults() = myScope.ReadList(ASCIIType_BSTR)
MsgBox "Timebase range: " + strResults(0) + ", delay: " + strResults(1)
```

To read the `:TIMEbase:RANGE?;DElay?` query result into multiple numeric variables, you could use the `ReadList` method to read the query results into a variant array variable using the commands:

```
myScope.WriteString ":TIMEbase:RANGE?;DElay?"
Dim varResults() As Variant
varResults() = myScope.ReadList
MsgBox "Timebase range: " + FormatNumber(varResults(0) * 1000, 4) + _
      " ms, delay: " + FormatNumber(varResults(1) * 1000000, 4) + " us"
```

Checking Instrument Status

Status registers track the current status of the instrument. By checking the instrument status, you can find out whether an operation has been completed, whether the instrument is receiving triggers, and more.

For more information, see [Chapter 9](#), “Status Reporting,” starting on page 751 which explains how to check the status of the instrument.

Other Ways of Sending Commands

Standard Commands for Programmable Instrumentation (SCPI) can be sent via a Telnet socket or through the Browser Web Control.

Telnet Sockets

The following information is provided for programmers who wish to control the oscilloscope with SCPI commands in a Telnet session.

To connect to the oscilloscope via a telnet socket, issue the following command:

```
telnet <hostname> 5024
```

where <hostname> is the hostname of the oscilloscope. This will give you a command line with prompt.

For a command line without a prompt, use port 5025. For example:

```
telnet <hostname> 5025
```

Sending SCPI Commands Using Browser Web Control

To send SCPI commands using the Browser Web Control feature, establish a connection to the oscilloscope via LAN as described in the *7000 Series Oscilloscopes User's Guide*. When you make the connection to the oscilloscope via LAN and the instrument's welcome page is displayed, select the **Browser Web Control** tab, then select the **Remote Programming** link.

3 Getting Started



4 Commands Quick Reference

Command Summary 60

Syntax Elements 108



Command Summary

Table 2 Common (*) Commands Summary

Command	Query	Options and Query Returns																																				
*CLS (see page 117)	n/a	n/a																																				
*ESE <mask> (see page 118)	*ESE? (see page 119)	<p><mask> ::= 0 to 255; an integer in NR1 format:</p> <table border="1"> <thead> <tr> <th>Bit</th> <th>Weight</th> <th>Name</th> <th>Enables</th> </tr> </thead> <tbody> <tr> <td>7</td> <td>128</td> <td>PON</td> <td>Power On</td> </tr> <tr> <td>6</td> <td>64</td> <td>URQ</td> <td>User Request</td> </tr> <tr> <td>5</td> <td>32</td> <td>CME</td> <td>Command Error</td> </tr> <tr> <td>4</td> <td>16</td> <td>EXE</td> <td>Execution Error</td> </tr> <tr> <td>3</td> <td>8</td> <td>DDE</td> <td>Dev. Dependent Error</td> </tr> <tr> <td>2</td> <td>4</td> <td>QYE</td> <td>Query Error</td> </tr> <tr> <td>1</td> <td>2</td> <td>RQL</td> <td>Request Control</td> </tr> <tr> <td>0</td> <td>1</td> <td>OPC</td> <td>Operation Complete</td> </tr> </tbody> </table>	Bit	Weight	Name	Enables	7	128	PON	Power On	6	64	URQ	User Request	5	32	CME	Command Error	4	16	EXE	Execution Error	3	8	DDE	Dev. Dependent Error	2	4	QYE	Query Error	1	2	RQL	Request Control	0	1	OPC	Operation Complete
Bit	Weight	Name	Enables																																			
7	128	PON	Power On																																			
6	64	URQ	User Request																																			
5	32	CME	Command Error																																			
4	16	EXE	Execution Error																																			
3	8	DDE	Dev. Dependent Error																																			
2	4	QYE	Query Error																																			
1	2	RQL	Request Control																																			
0	1	OPC	Operation Complete																																			
n/a	*ESR? (see page 120)	<status> ::= 0 to 255; an integer in NR1 format																																				
n/a	*IDN? (see page 120)	AGILENT TECHNOLOGIES,<model>,<serial number>,X.XX.XX <model> ::= the model number of the instrument <serial number> ::= the serial number of the instrument <X.XX.XX> ::= the software revision of the instrument																																				
n/a	*LRN? (see page 123)	<learn_string> ::= current instrument setup as a block of data in IEEE 488.2 # format																																				
*OPC (see page 124)	*OPC? (see page 124)	ASCII "1" is placed in the output queue when all pending device operations have completed.																																				

Table 2 Common (*) Commands Summary (continued)

Command	Query	Options and Query Returns
n/a	*OPT? (see page 125)	<pre> <return_value> ::= 0,0,<license info> <license info> ::= <All field>, <reserved>, <Factory MSO>, <Upgraded MSO>, <Xilinx FPGA Probe>, <Memory>, <Low Speed Serial>, <Automotive Serial>, <reserved>, <Secure>, <Battery>, <Altera FPGA Probe>, <FlexRay Serial>, <Power Measurements>, <RS-232/UART Serial>, <reserved>, <Segmented Memory>, <Mask Test>, <reserved>, <reserved>, <FlexRay Conformance>, <reserved>, <reserved>, <I2S Serial>, <FlexRay Trigger/Decode>, <reserved>, <reserved>, <MIL-STD 1553 Trigger/Decode>, <reserved> <All field> ::= {0 All} <reserved> ::= 0 <Factory MSO> ::= {0 MSO} <Upgraded MSO> ::= {0 MSO} <Xilinx FPGA Probe> ::= {0 FPG} <Memory> ::= {0 mem2M mem8M} <Low Speed Serial> ::= {0 LSS} <Automotive Serial> ::= {0 AMS} <Secure> ::= {0 SEC} <Battery> ::= {0 BAT} <Altera FPGA Probe> ::= {0 ALT} <FlexRay Serial> ::= {0 FRS} <Power Measurements> ::= {0 PWR} <RS-232/UART Serial> ::= {0 232} <Segmented Memory> ::= {0 SGM} <Mask Test> ::= {0 LMT} <FlexRay Conformance> ::= {0 FRC} <I2S Serial> ::= {0 SND} <FlexRay Trigger/Decode> ::= {0 FLX} <MIL-STD 1553 Trigger/Decode> ::= {0 553} </pre>

4 Commands Quick Reference

Table 2 Common (*) Commands Summary (continued)

Command	Query	Options and Query Returns
*RCL <value> (see page 127)	n/a	<value> ::= {0 1 2 3 4 5 6 7 8 9}
*RST (see page 128)	n/a	See *RST (Reset) (see page 128)
*SAV <value> (see page 131)	n/a	<value> ::= {0 1 2 3 4 5 6 7 8 9}
*SRE <mask> (see page 132)	*SRE? (see page 133)	<p><mask> ::= sum of all bits that are set, 0 to 255; an integer in NR1 format. <mask> ::= following values:</p> <pre> Bit Weight Name Enables ----- 7 128 OPER Operation Status Reg 6 64 ---- (Not used.) 5 32 ESB Event Status Bit 4 16 MAV Message Available 3 8 ---- (Not used.) 2 4 MSG Message 1 2 USR User 0 1 TRG Trigger </pre>
n/a	*STB? (see page 134)	<p><value> ::= 0 to 255; an integer in NR1 format, as shown in the following:</p> <pre> Bit Weight Name "1" Indicates ----- 7 128 OPER Operation status condition occurred. 6 64 RQS/ Instrument is MSS requesting service. 5 32 ESB Enabled event status condition occurred. 4 16 MAV Message available. 3 8 ---- (Not used.) 2 4 MSG Message displayed. 1 2 USR User event condition occurred. 0 1 TRG A trigger occurred. </pre>
*TRG (see page 136)	n/a	n/a
n/a	*TST? (see page 137)	<result> ::= 0 or non-zero value; an integer in NR1 format
*WAI (see page 138)	n/a	n/a

Table 3 Root (:) Commands Summary

Command	Query	Options and Query Returns
:ACTivity (see page 142)	:ACTivity? (see page 142)	<return value> ::= <edges>,<levels> <edges> ::= presence of edges (32-bit integer in NR1 format) <levels> ::= logical highs or lows (32-bit integer in NR1 format)
n/a	:AER? (see page 143)	{0 1}; an integer in NR1 format
:AUToscale [<source>[,...,<source>]] (see page 144)	n/a	<source> ::= CHANNEL<n> for DSO models <source> ::= {CHANNEL<n> DIGital0,...,DIGital15 POD1 POD2} for MSO models <source> can be repeated up to 5 times <n> ::= 1-2 or 1-4 in NR1 format
:AUToscale:AMODE <value> (see page 146)	:AUToscale:AMODE? (see page 146)	<value> ::= {NORMAL CURRENT}}
:AUToscale:CHANNELs <value> (see page 147)	:AUToscale:CHANNELs? (see page 147)	<value> ::= {ALL DISPLAYed}}
:BLANK [<source>] (see page 148)	n/a	<source> ::= {CHANNEL<n>} FUNCTION MATH SBUS} for DSO models <source> ::= {CHANNEL<n> DIGital0,...,DIGital15 POD{1 2} BUS{1 2} FUNCTION MATH SBUS} for MSO models <n> ::= 1-2 or 1-4 in NR1 format
:CDISplay (see page 149)	n/a	n/a
:DIGitize [<source>[,...,<source>]] (see page 150)	n/a	<source> ::= {CHANNEL<n> FUNCTION MATH SBUS} for DSO models <source> ::= {CHANNEL<n> DIGital0,...,DIGital15 POD{1 2} BUS{1 2} FUNCTION MATH SBUS} for MSO models <source> can be repeated up to 5 times <n> ::= 1-2 or 1-4 in NR1 format

4 Commands Quick Reference

Table 3 Root (:) Commands Summary (continued)

Command	Query	Options and Query Returns
:HWEenable <n> (see page 152)	:HWEenable? (see page 152)	<n> ::= 16-bit integer in NR1 format
n/a	:HWEregister:CONDition? (see page 154)	<n> ::= 16-bit integer in NR1 format
n/a	:HWEregister[:EVENT]? (see page 156)	<n> ::= 16-bit integer in NR1 format
:MERGE <pixel memory> (see page 158)	n/a	<pixel memory> ::= {PMEMory{0 1 2 3 4 5 6 7 8 9}}
:MTEenable <n> (see page 159)	:MTEenable? (see page 159)	<n> ::= 16-bit integer in NR1 format
n/a	:MTEregister[:EVENT]? (see page 161)	<n> ::= 16-bit integer in NR1 format
:OPEE <n> (see page 163)	:OPEE? (see page 164)	<n> ::= 16-bit integer in NR1 format
n/a	:OPERregister:CONDition? (see page 165)	<n> ::= 16-bit integer in NR1 format
n/a	:OPERregister[:EVENT]? (see page 167)	<n> ::= 16-bit integer in NR1 format
:OVLenable <mask> (see page 169)	:OVLenable? (see page 170)	<p><mask> ::= 16-bit integer in NR1 format as shown:</p> <pre> Bit Weight Input ----- 10 1024 Ext Trigger Fault 9 512 Channel 4 Fault 8 256 Channel 3 Fault 7 128 Channel 2 Fault 6 64 Channel 1 Fault 4 16 Ext Trigger OVL 3 8 Channel 4 OVL 2 4 Channel 3 OVL 1 2 Channel 2 OVL 0 1 Channel 1 OVL </pre>
n/a	:OVLRegister? (see page 171)	<value> ::= integer in NR1 format. See OVLenable for <value>
:PRINT [<options>] (see page 173)	n/a	<p><options> ::= [<print option>][, ..., <print option>]</p> <p><print option> ::= {COLor GRAYscale PRINter0 BMP8bit BMP PNG NOFactoRs FACToRs}</p> <p><print option> can be repeated up to 5 times.</p>

Table 3 Root (:) Commands Summary (continued)

Command	Query	Options and Query Returns
:RUN (see page 174)	n/a	n/a
n/a	:SERial (see page 175)	<return value> ::= unquoted string containing serial number
:SINGle (see page 176)	n/a	n/a
n/a	:STATus? <display> (see page 177)	{0 1} <display> ::= {CHANnel<n> DIGital0,...,DIGital15 POD{1 2} BUS{1 2} FUNCTION MATH SBUS} <n> ::= 1-2 or 1-4 in NR1 format
:STOP (see page 178)	n/a	n/a
n/a	:TER? (see page 179)	{0 1}
:VIEW <source> (see page 180)	n/a	<source> ::= {CHANnel<n> PMEMory{0 1 2 3 4 5 6 7 8 9} FUNCTION MATH SBUS} for DSO models <source> ::= {CHANnel<n> DIGital0,...,DIGital15 PMEMory{0 1 2 3 4 5 6 7 8 9} POD{1 2} BUS{1 2} FUNCTION MATH SBUS} for MSO models <n> ::= 1-2 or 1-4 in NR1 format

Table 4 :ACQuire Commands Summary

Command	Query	Options and Query Returns
n/a	:ACQuire:AAlias? (see page 183)	{1 0}
:ACQuire:COMplete <complete> (see page 184)	:ACQuire:COMplete? (see page 184)	<complete> ::= 100; an integer in NR1 format
:ACQuire:COUNT <count> (see page 185)	:ACQuire:COUNT? (see page 185)	<count> ::= an integer from 2 to 65536 in NR1 format
:ACQuire:DAALias <mode> (see page 186)	:ACQuire:DAALias? (see page 186)	<mode> ::= {DISable AUTO}
:ACQuire:MODE <mode> (see page 187)	:ACQuire:MODE? (see page 187)	<mode> ::= {RTIME ETIME SEGmented}

4 Commands Quick Reference

Table 4 :ACQUIRE Commands Summary (continued)

Command	Query	Options and Query Returns
n/a	:ACQUIRE:POINTS? (see page 188)	<# points> ::= an integer in NR1 format
:ACQUIRE:RSIGNAL <ref_signal_mode> (see page 189)	:ACQUIRE:RSIGNAL? (see page 189)	<ref_signal_mode> ::= {OFF OUT IN}
:ACQUIRE:SEGMENTED:ANALYZE (see page 190)	n/a	n/a (with Option SGM)
:ACQUIRE:SEGMENTED:COUNT <count> (see page 191)	:ACQUIRE:SEGMENTED:COUNT? (see page 191)	<count> ::= an integer from 2 to 2000 (w/8M memory) in NR1 format (with Option SGM)
:ACQUIRE:SEGMENTED:INDEX <index> (see page 192)	:ACQUIRE:SEGMENTED:INDEX? (see page 192)	<index> ::= an integer from 2 to 2000 (w/8M memory) in NR1 format (with Option SGM)
n/a	:ACQUIRE:SRATE? (see page 195)	<sample_rate> ::= sample rate (samples/s) in NR3 format
:ACQUIRE:TYPE <type> (see page 196)	:ACQUIRE:TYPE? (see page 196)	<type> ::= {NORMAL AVERAGE HRESOLUTION PEAK}

Table 5 :BUS<n> Commands Summary

Command	Query	Options and Query Returns
:BUS<n>:BIT<m> {{0 OFF} {1 ON}} (see page 200)	:BUS<n>:BIT<m>? (see page 200)	{0 1} <n> ::= 1 or 2; an integer in NR1 format <m> ::= 0-15; an integer in NR1 format
:BUS<n>:BITS <channel_list>, {{0 OFF} {1 ON}} (see page 201)	:BUS<n>:BITS? (see page 201)	<channel_list>, {0 1} <channel_list> ::= (@<m>, <m>:<m> ...) where ", " is separator and ":" is range <n> ::= 1 or 2; an integer in NR1 format <m> ::= 0-15; an integer in NR1 format
:BUS<n>:CLEAR (see page 203)	n/a	<n> ::= 1 or 2; an integer in NR1 format
:BUS<n>:DISPLAY {{0 OFF} {1 ON}} (see page 204)	:BUS<n>:DISPLAY? (see page 204)	{0 1} <n> ::= 1 or 2; an integer in NR1 format

Table 5 :BUS<n> Commands Summary (continued)

Command	Query	Options and Query Returns
:BUS<n>:LAbel <string> (see page 205)	:BUS<n>:LAbel? (see page 205)	<string> ::= quoted ASCII string up to 10 characters <n> ::= 1 or 2; an integer in NR1 format
:BUS<n>:MASK <mask> (see page 206)	:BUS<n>:MASK? (see page 206)	<mask> ::= 32-bit integer in decimal, <nondecimal>, or <string> <nondecimal> ::= #Hnn...n where n ::= {0,...,9 A,...,F} for hexadecimal <nondecimal> ::= #Bnn...n where n ::= {0 1} for binary <string> ::= "0xnn...n" where n ::= {0,...,9 A,...,F} for hexadecimal <n> ::= 1 or 2; an integer in NR1 format

Table 6 :CALibrate Commands Summary

Command	Query	Options and Query Returns
n/a	:CALibrate:DATE? (see page 209)	<return value> ::= <day>,<month>,<year>; all in NR1 format
:CALibrate:LAbel <string> (see page 210)	:CALibrate:LAbel? (see page 210)	<string> ::= quoted ASCII string up to 32 characters
:CALibrate:OUTPut <signal> (see page 211)	:CALibrate:OUTPut? (see page 211)	<signal> ::= {TRIGgers SOURce DSOURce MASK}
:CALibrate:STARt (see page 212)	n/a	n/a
n/a	:CALibrate:STATus? (see page 213)	<return value> ::= ALL,<status_code>,<status_string > <status_code> ::= an integer status code <status_string> ::= an ASCII status string
n/a	:CALibrate:SWITCh? (see page 214)	{PROtected UNPRotected}

4 Commands Quick Reference

Table 6 :CALibrate Commands Summary (continued)

Command	Query	Options and Query Returns
n/a	:CALibrate:TEMPerature? (see page 215)	<return value> ::= degrees C delta since last cal in NR3 format
n/a	:CALibrate:TIME? (see page 216)	<return value> ::= <hours>,<minutes>,<seconds>; all in NR1 format

Table 7 :CHANnel<n> Commands Summary

Command	Query	Options and Query Returns
:CHANnel<n>:BWLimit {0 OFF} {1 ON}} (see page 220)	:CHANnel<n>:BWLimit? (see page 220)	{0 1} <n> ::= 1-2 or 1-4 in NR1 format
:CHANnel<n>:COUpling <coupling> (see page 221)	:CHANnel<n>:COUpling? (see page 221)	<coupling> ::= {AC DC} <n> ::= 1-2 or 1-4 in NR1 format
:CHANnel<n>:DISPlay {0 OFF} {1 ON}} (see page 222)	:CHANnel<n>:DISPlay? (see page 222)	{0 1} <n> ::= 1-2 or 1-4 in NR1 format
:CHANnel<n>:IMPedance <impedance> (see page 223)	:CHANnel<n>:IMPedance? (see page 223)	<impedance> ::= {ONEMeg FIFTy} <n> ::= 1-2 or 1-4 in NR1 format
:CHANnel<n>:INVert {0 OFF} {1 ON}} (see page 224)	:CHANnel<n>:INVert? (see page 224)	{0 1} <n> ::= 1-2 or 1-4 in NR1 format
:CHANnel<n>:LABel <string> (see page 225)	:CHANnel<n>:LABel? (see page 225)	<string> ::= any series of 10 or less ASCII characters enclosed in quotation marks <n> ::= 1-2 or 1-4 in NR1 format
:CHANnel<n>:OFFSet <offset>[suffix] (see page 226)	:CHANnel<n>:OFFSet? (see page 226)	<offset> ::= Vertical offset value in NR3 format [suffix] ::= {V mV} <n> ::= 1-2 or 1-4; in NR1 format
:CHANnel<n>:PROBe <attenuation> (see page 227)	:CHANnel<n>:PROBe? (see page 227)	<attenuation> ::= Probe attenuation ratio in NR3 format <n> ::= 1-2 or 1-4r in NR1 format
:CHANnel<n>:PROBe:HEAD[:TYPE] <head_param> (see page 228)	:CHANnel<n>:PROBe:HEAD[:TYPE]? (see page 228)	<head_param> ::= {SEND0 SEND6 SEND12 SEND20 DIFF0 DIFF6 DIFF12 DIFF20 NONE} <n> ::= 1-2 or 1-4 in NR1 format

Table 7 :CHANnel<n> Commands Summary (continued)

Command	Query	Options and Query Returns
n/a	:CHANnel<n>:PROBe:ID? (see page 229)	<probe id> ::= unquoted ASCII string up to 11 characters <n> ::= 1-2 or 1-4 in NR1 format
:CHANnel<n>:PROBe:SKEW <skew_value> (see page 230)	:CHANnel<n>:PROBe:SKEW? (see page 230)	<skew_value> ::= -100 ns to +100 ns in NR3 format <n> ::= 1-2 or 1-4 in NR1 format
:CHANnel<n>:PROBe:STYPe <signal type> (see page 231)	:CHANnel<n>:PROBe:STYPe? (see page 231)	<signal type> ::= {DIFFerential SINGLE} <n> ::= 1-2 or 1-4 in NR1 format
:CHANnel<n>:PROTection (see page 232)	:CHANnel<n>:PROTection? (see page 232)	{NORM TRIP} <n> ::= 1-2 or 1-4 in NR1 format
:CHANnel<n>:RANGe <range>[suffix] (see page 233)	:CHANnel<n>:RANGe? (see page 233)	<range> ::= Vertical full-scale range value in NR3 format [suffix] ::= {V mV} <n> ::= 1-2 or 1-4 in NR1 format
:CHANnel<n>:SCALe <scale>[suffix] (see page 234)	:CHANnel<n>:SCALe? (see page 234)	<scale> ::= Vertical units per division value in NR3 format [suffix] ::= {V mV} <n> ::= 1-2 or 1-4 in NR1 format
:CHANnel<n>:UNITs <units> (see page 235)	:CHANnel<n>:UNITs? (see page 235)	<units> ::= {VOLT AMPere} <n> ::= 1-2 or 1-4 in NR1 format
:CHANnel<n>:VERNier {{0 OFF} {1 ON}} (see page 236)	:CHANnel<n>:VERNier? (see page 236)	{0 1} <n> ::= 1-2 or 1-4 in NR1 format

Table 8 :DIGital<n> Commands Summary

Command	Query	Options and Query Returns
:DIGital<n>:DISPlay {{0 OFF} {1 ON}} (see page 239)	:DIGital<n>:DISPlay? (see page 239)	{0 1} <n> ::= 0-15; an integer in NR1 format
:DIGital<n>:LABel <string> (see page 240)	:DIGital<n>:LABel? (see page 240)	<string> ::= any series of 10 or less ASCII characters enclosed in quotation marks <n> ::= 0-15; an integer in NR1 format

4 Commands Quick Reference

Table 8 :DIGital<n> Commands Summary (continued)

Command	Query	Options and Query Returns
:DIGital<n>:POSition <position> (see page 241)	:DIGital<n>:POSition? (see page 241)	<n> ::= 0-15; an integer in NR1 format <position> ::= 0-7 if display size = large, 0-15 if size = medium, 0-31 if size = small
:DIGital<n>:SIZE <value> (see page 242)	:DIGital<n>:SIZE? (see page 242)	<value> ::= {SMALl MEDium LARGE}
:DIGital<n>:THReshold <value>[suffix] (see page 243)	:DIGital<n>:THReshold ? (see page 243)	<n> ::= 0-15; an integer in NR1 format <value> ::= {CMOS ECL TTL <user defined value>} <user defined value> ::= value in NR3 format from -8.00 to +8.00 [suffix] ::= {V mV uV}

Table 9 :DISPlay Commands Summary

Command	Query	Options and Query Returns
:DISPlay:CLear (see page 246)	n/a	n/a
:DISPlay:DATA [<format>][,][<area>] [,][<palette>]<displa y data> (see page 247)	:DISPlay:DATA? [<format>][,][<area>] [,][<palette>] (see page 247)	<format> ::= {TIFF} (command) <area> ::= {GRATicule} (command) <palette> ::= {MONochrome} (command) <format> ::= {TIFF BMP BMP8bit PNG} (query) <area> ::= {GRATicule SCReen} (query) <palette> ::= {MONochrome GRAYscale COLor} (query) <display data> ::= data in IEEE 488.2 # format
:DISPlay:LABel {{0 OFF} {1 ON}} (see page 249)	:DISPlay:LABel? (see page 249)	{0 1}
:DISPlay:LABList <binary block> (see page 250)	:DISPlay:LABList? (see page 250)	<binary block> ::= an ordered list of up to 75 labels, each 10 characters maximum, separated by newline characters

Table 9 :DISPlay Commands Summary (continued)

Command	Query	Options and Query Returns
:DISPlay:PERsistence <value> (see page 251)	:DISPlay:PERsistence? (see page 251)	<value> ::= {MINimum INFinite}}
:DISPlay:SOURce <value> (see page 252)	:DISPlay:SOURce? (see page 252)	<value> ::= {PMEMemory{0 1 2 3 4 5 6 7 8 9}}
:DISPlay:VECTors {{1 ON} {0 OFF}} (see page 253)	:DISPlay:VECTors? (see page 253)	{1 0}

Table 10 :EXTErnal Trigger Commands Summary

Command	Query	Options and Query Returns
:EXTErnal:BWLimit <bwlimit> (see page 256)	:EXTErnal:BWLimit? (see page 256)	<bwlimit> ::= {0 OFF}
:EXTErnal:IMPedance <value> (see page 257)	:EXTErnal:IMPedance? (see page 257)	<impedance> ::= {ONEMeg FIFTy}
:EXTErnal:PROBe <attenuation> (see page 258)	:EXTErnal:PROBe? (see page 258)	<attenuation> ::= probe attenuation ratio in NR3 format
n/a	:EXTErnal:PROBe:ID? (see page 259)	<probe id> ::= unquoted ASCII string up to 11 characters
:EXTErnal:PROBe:STYPe <signal type> (see page 260)	:EXTErnal:PROBe:STYPe ? (see page 260)	<signal type> ::= {DIFFerential SINGle}
:EXTErnal:PROTEction[:CLEar] (see page 261)	:EXTErnal:PROTEction? (see page 261)	{NORM TRIP}
:EXTErnal:RANGe <range> [<suffix>] (see page 262)	:EXTErnal:RANGe? (see page 262)	<range> ::= vertical full-scale range value in NR3 format <suffix> ::= {V mV}
:EXTErnal:UNITs <units> (see page 263)	:EXTErnal:UNITs? (see page 263)	<units> ::= {VOLT AMPere}

Table 11 :FUNCTION Commands Summary

Command	Query	Options and Query Returns
:FUNCTION:CENTer <frequency> (see page 267)	:FUNCTION:CENTer? (see page 267)	<frequency> ::= the current center frequency in NR3 format. The range of legal values is from 0 Hz to 25 GHz.
:FUNCTION:DISPlay {{0 OFF} {1 ON}} (see page 268)	:FUNCTION:DISPlay? (see page 268)	{0 1}
:FUNCTION:GOFT:OPERat ion <operation> (see page 269)	:FUNCTION:GOFT:OPERat ion? (see page 269)	<operation> ::= {ADD SUBTract MULTiPly}
:FUNCTION:GOFT:SOURce 1 <source> (see page 270)	:FUNCTION:GOFT:SOURce 1? (see page 270)	<source> ::= CHANnel<n> <n> ::= {1 2 3 4} for 4ch models <n> ::= {1 2} for 2ch models
:FUNCTION:GOFT:SOURce 2 <source> (see page 271)	:FUNCTION:GOFT:SOURce 2? (see page 271)	<source> ::= CHANnel<n> <n> ::= {{1 2} {3 4}} for 4ch models, depending on SOURce1 selection <n> ::= {1 2} for 2ch models
:FUNCTION:OFFSet <offset> (see page 272)	:FUNCTION:OFFSet? (see page 272)	<offset> ::= the value at center screen in NR3 format. The range of legal values is +/-10 times the current sensitivity of the selected function.
:FUNCTION:OPERation <operation> (see page 273)	:FUNCTION:OPERation? (see page 273)	<operation> ::= {ADD SUBTract MULTiPly INTegrate DIFFerentiate FFT SQRT}
:FUNCTION:RANGe <range> (see page 274)	:FUNCTION:RANGe? (see page 274)	<range> ::= the full-scale vertical axis value in NR3 format. The range for ADD, SUBT, MULT is 8E-6 to 800E+3. The range for the INTegrate function is 8E-9 to 400E+3. The range for the DIFFerentiate function is 80E-3 to 8.0E12 (depends on current sweep speed). The range for the FFT function is 8 to 800 dBV.

Table 11 :FUNCTION Commands Summary (continued)

Command	Query	Options and Query Returns
:FUNCTION:REFERENCE <level> (see page 275)	:FUNCTION:REFERENCE? (see page 275)	<level> ::= the value at center screen in NR3 format. The range of legal values is +/-10 times the current sensitivity of the selected function.
:FUNCTION:SCALE <scale value>[<suffix>] (see page 276)	:FUNCTION:SCALE? (see page 276)	<scale value> ::= integer in NR1 format <suffix> ::= {V dB}
:FUNCTION:SOURCE1 <source> (see page 277)	:FUNCTION:SOURCE1? (see page 277)	<source> ::= {CHANNEL<n> GOFT} <n> ::= {1 2 3 4} for 4ch models <n> ::= {1 2} for 2ch models GOFT is only for FFT, INTEGRATE, DIFFERENTIATE, and SQRT operations.
:FUNCTION:SOURCE2 <source> (see page 278)	:FUNCTION:SOURCE2? (see page 278)	<source> ::= {CHANNEL<n> NONE} <n> ::= {{1 2} {3 4}} for 4ch models, depending on SOURCE1 selection <n> ::= {1 2} for 2ch models
:FUNCTION:SPAN (see page 279)	:FUNCTION:SPAN? (see page 279)	 ::= the current frequency span in NR3 format. Legal values are 1 Hz to 100 GHz.
:FUNCTION:WINDOW <window> (see page 280)	:FUNCTION:WINDOW? (see page 280)	<window> ::= {RECTANGULAR HANNING FLATTOP BHARRIS}

Table 12 :HARDcopy Commands Summary

Command	Query	Options and Query Returns
:HARDcopy:AREA <area> (see page 283)	:HARDcopy:AREA? (see page 283)	<area> ::= SCREEN
:HARDcopy:APRINTER <active_printer> (see page 284)	:HARDcopy:APRINTER? (see page 284)	<active_printer> ::= {<index> <name>} <index> ::= integer index of printer in list <name> ::= name of printer in list

4 Commands Quick Reference

Table 12 :HARDcopy Commands Summary (continued)

Command	Query	Options and Query Returns
:HARDcopy:FACTors {{0 OFF} {1 ON}} (see page 285)	:HARDcopy:FACTors? (see page 285)	{0 1}
:HARDcopy:FFeEd {{0 OFF} {1 ON}} (see page 286)	:HARDcopy:FFeEd? (see page 286)	{0 1}
:HARDcopy:INKSaver {{0 OFF} {1 ON}} (see page 287)	:HARDcopy:INKSaver? (see page 287)	{0 1}
:HARDcopy:LAYout <layout> (see page 288)	:HARDcopy:LAYout? (see page 288)	<layout> ::= {LANDscape PORTRait}
:HARDcopy:PAlette <palette> (see page 289)	:HARDcopy:PAlette? (see page 289)	<palette> ::= {COLor GRAYscale NONE}
n/a	:HARDcopy:PRINter:LIS T? (see page 290)	<list> ::= [<printer_spec>] ... [printer_spec] <printer_spec> ::= "<index>,<active>,<name>;" <index> ::= integer index of printer <active> ::= {Y N} <name> ::= name of printer
:HARDcopy:STARt (see page 291)	n/a	n/a

Table 13 :LISTer Commands Summary

Command	Query	Options and Query Returns
n/a	:LISTer:DATA? (see page 293)	<binary_block> ::= comma-separated data with newlines at the end of each row
:LISTer:DISPlay {{0 OFF} {1 ON}} (see page 294)	:LISTer:DISPlay? (see page 294)	{0 1}

Table 14 :MARKer Commands Summary

Command	Query	Options and Query Returns
:MARKer:MODE <mode> (see page 297)	:MARKer:MODE? (see page 297)	<mode> ::= {OFF MEASurement MANual WAVeform}
:MARKer:X1Position <position>[suffix] (see page 298)	:MARKer:X1Position? (see page 298)	<position> ::= X1 cursor position value in NR3 format [suffix] ::= {s ms us ns ps Hz kHz MHz} <return_value> ::= X1 cursor position value in NR3 format
:MARKer:X1Y1source <source> (see page 299)	:MARKer:X1Y1source? (see page 299)	<source> ::= {CHANnel<n> FUNction MATH} <n> ::= 1-2 or 1-4 in NR1 format <return_value> ::= <source>
:MARKer:X2Position <position>[suffix] (see page 300)	:MARKer:X2Position? (see page 300)	<position> ::= X2 cursor position value in NR3 format [suffix] ::= {s ms us ns ps Hz kHz MHz} <return_value> ::= X2 cursor position value in NR3 format
:MARKer:X2Y2source <source> (see page 301)	:MARKer:X2Y2source? (see page 301)	<source> ::= {CHANnel<n> FUNction MATH} <n> ::= 1-2 or 1-4 in NR1 format <return_value> ::= <source>
n/a	:MARKer:XDELta? (see page 302)	<return_value> ::= X cursors delta value in NR3 format
:MARKer:Y1Position <position>[suffix] (see page 303)	:MARKer:Y1Position? (see page 303)	<position> ::= Y1 cursor position value in NR3 format [suffix] ::= {V mV dB} <return_value> ::= Y1 cursor position value in NR3 format
:MARKer:Y2Position <position>[suffix] (see page 304)	:MARKer:Y2Position? (see page 304)	<position> ::= Y2 cursor position value in NR3 format [suffix] ::= {V mV dB} <return_value> ::= Y2 cursor position value in NR3 format
n/a	:MARKer:YDELta? (see page 305)	<return_value> ::= Y cursors delta value in NR3 format

Table 15 :MEASure Commands Summary

Command	Query	Options and Query Returns
:MEASure:CLEar (see page 314)	n/a	n/a
:MEASure:COUNter [<source>] (see page 315)	:MEASure:COUNter? [<source>] (see page 315)	<source> ::= {CHANnel<n> EXTernal} for DSO models <source> ::= {CHANnel<n> DIGital0,...,DIGital15 EXTernal} for MSO models <n> ::= 1-2 or 1-4 in NR1 format <return_value> ::= counter frequency in Hertz in NR3 format
:MEASure:DEFine DELay, <delay spec> (see page 316)	:MEASure:DEFine? DELay (see page 317)	<delay spec> ::= <edge_spec1>,<edge_spec2> edge_spec1 ::= [<slope>]<occurrence> edge_spec2 ::= [<slope>]<occurrence> <slope> ::= {+ -} <occurrence> ::= integer
:MEASure:DEFine THResholds, <threshold spec> (see page 316)	:MEASure:DEFine? THResholds (see page 317)	<threshold spec> ::= {STANdard} {<threshold mode>,<upper>,<middle>,<lower>} <threshold mode> ::= {PERCent ABSolute}
:MEASure:DELay [<source1> [,<source2>] (see page 319)	:MEASure:DELay? [<source1> [,<source2>] (see page 319)	<source1,2> ::= {CHANnel<n> FUNction MATH} <n> ::= 1-2 or 1-4 in NR1 format <return_value> ::= floating-point number delay time in seconds in NR3 format
:MEASure:DUTYcycle [<source>] (see page 321)	:MEASure:DUTYcycle? [<source>] (see page 321)	<source> ::= {CHANnel<n> FUNction MATH} for DSO models <source> ::= {CHANnel<n> DIGital0,...,DIGital15 FUNction MATH} for MSO models <n> ::= 1-2 or 1-4 in NR1 format <return_value> ::= ratio of positive pulse width to period in NR3 format

Table 15 :MEASure Commands Summary (continued)

Command	Query	Options and Query Returns
:MEASure:FALLtime [<source>] (see page 322)	:MEASure:FALLtime? [<source>] (see page 322)	<source> ::= {CHANnel<n> FUNctIon MATH} for DSO models <source> ::= {CHANnel<n> DIGital0,...,DIGital15 FUNctIon MATH} for MSO models <n> ::= 1-2 or 1-4 in NR1 format <return_value> ::= time in seconds between the lower and upper thresholds in NR3 format
:MEASure:FREQuency [<source>] (see page 323)	:MEASure:FREQuency? [<source>] (see page 323)	<source> ::= {CHANnel<n> FUNctIon MATH} for DSO models <source> ::= {CHANnel<n> DIGital0,...,DIGital15 FUNctIon MATH} for MSO models <n> ::= 1-2 or 1-4 in NR1 format <return_value> ::= frequency in Hertz in NR3 format
:MEASure:NWIDth [<source>] (see page 324)	:MEASure:NWIDth? [<source>] (see page 324)	<source> ::= {CHANnel<n> FUNctIon MATH} for DSO models <source> ::= {CHANnel<n> DIGital0,...,DIGital15 FUNctIon MATH} for MSO models <n> ::= 1-2 or 1-4 in NR1 format <return_value> ::= negative pulse width in seconds-NR3 format
:MEASure:OVERshoot [<source>] (see page 325)	:MEASure:OVERshoot? [<source>] (see page 325)	<source> ::= {CHANnel<n> FUNctIon MATH} <n> ::= 1-2 or 1-4 in NR1 format <return_value> ::= the percent of the overshoot of the selected waveform in NR3 format
:MEASure:PERiod [<source>] (see page 327)	:MEASure:PERiod? [<source>] (see page 327)	<source> ::= {CHANnel<n> FUNctIon MATH} for DSO models <source> ::= {CHANnel<n> DIGital0,...,DIGital15 FUNctIon MATH} for MSO models <n> ::= 1-2 or 1-4 in NR1 format <return_value> ::= waveform period in seconds in NR3 format

4 Commands Quick Reference

Table 15 :MEASure Commands Summary (continued)

Command	Query	Options and Query Returns
:MEASure:PHASe [<source1>] [,<source2>] (see page 328)	:MEASure:PHASe? [<source1>] [,<source2>] (see page 328)	<source1,2> ::= {CHANnel<n> FUNction MATH} <n> ::= 1-2 or 1-4 in NR1 format <return_value> ::= the phase angle value in degrees in NR3 format
:MEASure:PREShoOt [<source>] (see page 329)	:MEASure:PREShoOt? [<source>] (see page 329)	<source> ::= {CHANnel<n> FUNction MATH} <n> ::= 1-2 or 1-4 in NR1 format <return_value> ::= the percent of preshoot of the selected waveform in NR3 format
:MEASure:PWIDth [<source>] (see page 330)	:MEASure:PWIDth? [<source>] (see page 330)	<source> ::= {CHANnel<n> FUNction MATH} for DSO models <source> ::= {CHANnel<n> DIGital0,..,DIGital15 FUNction MATH} for MSO models <n> ::= 1-2 or 1-4 in NR1 format <return_value> ::= width of positive pulse in seconds in NR3 format
n/a	:MEASure:RESults? <result_list> (see page 331)	<result_list> ::= comma-separated list of measurement results
:MEASure:RISetime [<source>] (see page 334)	:MEASure:RISetime? [<source>] (see page 334)	<source> ::= {CHANnel<n> FUNction MATH} <n> ::= 1-2 or 1-4 in NR1 format <return_value> ::= rise time in seconds in NR3 format
:MEASure:SDEVIation [<source>] (see page 335)	:MEASure:SDEVIation? [<source>] (see page 335)	<source> ::= {CHANnel<n> FUNction MATH} <n> ::= 1-2 or 1-4 in NR1 format <return_value> ::= calculated std deviation in NR3 format
:MEASure:SHOW {1 ON} (see page 336)	:MEASure:SHOW? (see page 336)	{1}

Table 15 :MEASure Commands Summary (continued)

Command	Query	Options and Query Returns
:MEASure:SOURce <source1> [,<source2>] (see page 337)	:MEASure:SOURce? (see page 337)	<source1,2> ::= {CHANnel<n> FUNctIon MATH EXtErnal} for DSO models <source1,2> ::= {CHANnel<n> DIGital0,...,DIGital15 FUNctIon MATH EXtErnal} for MSO models <n> ::= 1-2 or 1-4 in NR1 format <return_value> ::= {<source> NONE}
:MEASure:STATistics <type> (see page 339)	:MEASure:STATistics? (see page 339)	<type> ::= {{ON 1} CURRent MEAN MINimum MAXimum STDDev COUNT} ON ::= all statistics returned
:MEASure:STATistics:INCRement (see page 340)	n/a	n/a
:MEASure:STATistics:RESET (see page 341)	n/a	n/a
n/a	:MEASure:TEDGE? <slope><occurrence>[, <source>] (see page 342)	<slope> ::= direction of the waveform <occurrence> ::= the transition to be reported <source> ::= {CHANnel<n> FUNctIon MATH} for DSO models <source> ::= {CHANnel<n> DIGital0,...,DIGital15 FUNctIon MATH} for MSO models <n> ::= 1-2 or 1-4 in NR1 format <return_value> ::= time in seconds of the specified transition

Table 15 :MEASure Commands Summary (continued)

Command	Query	Options and Query Returns
n/a	:MEASure:TVALue? <value>, [<slope>]<occurrence> [,<source>] (see page 344)	<value> ::= voltage level that the waveform must cross. <slope> ::= direction of the waveform when <value> is crossed. <occurrence> ::= transitions reported. <return_value> ::= time in seconds of specified voltage crossing in NR3 format <source> ::= {CHANnel<n> FUNctIon MATH} for DSO models <source> ::= {CHANnel<n> DIGital0,...,DIGital15 FUNctIon MATH} for MSO models <n> ::= 1-2 or 1-4 in NR1 format
:MEASure:VAMPLitude [<source>] (see page 346)	:MEASure:VAMPLitude? [<source>] (see page 346)	<source> ::= {CHANnel<n> FUNctIon MATH} <n> ::= 1-2 or 1-4 in NR1 format <return_value> ::= the amplitude of the selected waveform in volts in NR3 format
:MEASure:VAverage [<source>] (see page 347)	:MEASure:VAverage? [<source>] (see page 347)	<source> ::= {CHANnel<n> FUNctIon MATH} <n> ::= 1-2 or 1-4 in NR1 format <return_value> ::= calculated average voltage in NR3 format
:MEASure:VBASe [<source>] (see page 348)	:MEASure:VBASe? [<source>] (see page 348)	<source> ::= {CHANnel<n> FUNctIon MATH} <n> ::= 1-2 or 1-4 in NR1 format <base_voltage> ::= voltage at the base of the selected waveform in NR3 format
:MEASure:VMAX [<source>] (see page 349)	:MEASure:VMAX? [<source>] (see page 349)	<source> ::= {CHANnel<n> FUNctIon MATH} <n> ::= 1-2 or 1-4 in NR1 format <return_value> ::= maximum voltage of the selected waveform in NR3 format
:MEASure:VMIN [<source>] (see page 350)	:MEASure:VMIN? [<source>] (see page 350)	<source> ::= {CHANnel<n> FUNctIon MATH} <n> ::= 1-2 or 1-4 in NR1 format <return_value> ::= minimum voltage of the selected waveform in NR3 format

Table 15 :MEASure Commands Summary (continued)

Command	Query	Options and Query Returns
:MEASure:VPP [<source>] (see page 351)	:MEASure:VPP? [<source>] (see page 351)	<source> ::= {CHANnel<n> FUNction MATH} <n> ::= 1-2 or 1-4 in NR1 format <return_value> ::= voltage peak-to-peak of the selected waveform in NR3 format
:MEASure:VRATio [<source1>] [,<source2>] (see page 328)	:MEASure:VRATio? [<source1>] [,<source2>] (see page 352)	<source1,2> ::= {CHANnel<n> FUNction MATH} <n> ::= 1-2 or 1-4 in NR1 format <return_value> ::= the ratio value in dB in NR3 format
:MEASure:VRMS [<source>] (see page 353)	:MEASure:VRMS? [<source>] (see page 353)	<source> ::= {CHANnel<n> FUNction MATH} <n> ::= 1-2 or 1-4 in NR1 format <return_value> ::= calculated dc RMS voltage in NR3 format
n/a	:MEASure:VTIME? <vtime>[,<source>] (see page 354)	<vtime> ::= displayed time from trigger in seconds in NR3 format <return_value> ::= voltage at the specified time in NR3 format <source> ::= {CHANnel<n> FUNction MATH} for DSO models <source> ::= {CHANnel<n> DIGital0,...,DIGital15 FUNction MATH} for MSO models <n> ::= 1-2 or 1-4 in NR1 format
:MEASure:VTOP [<source>] (see page 355)	:MEASure:VTOP? [<source>] (see page 355)	<source> ::= {CHANnel<n> FUNction MATH} <n> ::= 1-2 or 1-4 in NR1 format <return_value> ::= voltage at the top of the waveform in NR3 format
:MEASure:XMAX [<source>] (see page 356)	:MEASure:XMAX? [<source>] (see page 356)	<source> ::= {CHANnel<n> FUNction MATH} <n> ::= 1-2 or 1-4 in NR1 format <return_value> ::= horizontal value of the maximum in NR3 format
:MEASure:XMIN [<source>] (see page 357)	:MEASure:XMIN? [<source>] (see page 357)	<source> ::= {CHANnel<n> FUNction MATH} <n> ::= 1-2 or 1-4 in NR1 format <return_value> ::= horizontal value of the maximum in NR3 format

4 Commands Quick Reference

Table 16 :MTEST Commands Summary

Command	Query	Options and Query Returns
:MTEST:AMASK:CREate (see page 363)	n/a	n/a
:MTEST:AMASK:SOURce <source> (see page 364)	:MTEST:AMASK:SOURce? (see page 364)	<source> ::= CHANnel<n> <n> ::= {1 2 3 4} for 4ch models <n> ::= {1 2} for 2ch models
:MTEST:AMASK:UNITs <units> (see page 365)	:MTEST:AMASK:UNITs? (see page 365)	<units> ::= {CURRENT DIVisions}
:MTEST:AMASK:XDELta <value> (see page 366)	:MTEST:AMASK:XDELta? (see page 366)	<value> ::= X delta value in NR3 format
:MTEST:AMASK:YDELta <value> (see page 367)	:MTEST:AMASK:YDELta? (see page 367)	<value> ::= Y delta value in NR3 format
n/a	:MTEST:COUNT:FWAVEfor ms? [CHANnel<n>] (see page 368)	<failed> ::= number of failed waveforms in NR1 format
:MTEST:COUNT:RESet (see page 369)	n/a	n/a
n/a	:MTEST:COUNT:TIME? (see page 370)	<time> ::= elapsed seconds in NR3 format
n/a	:MTEST:COUNT:WAVEform s? (see page 371)	<count> ::= number of waveforms in NR1 format
:MTEST:DATA <mask> (see page 372)	:MTEST:DATA? (see page 372)	<mask> ::= data in IEEE 488.2 # format.
:MTEST:DELeTe (see page 373)	n/a	n/a
:MTEST:ENABle {{0 OFF} {1 ON}} (see page 374)	:MTEST:ENABle? (see page 374)	{0 1}
:MTEST:LOCK {{0 OFF} {1 ON}} (see page 375)	:MTEST:LOCK? (see page 375)	{0 1}
:MTEST:OUTPut <signal> (see page 376)	:MTEST:OUTPut? (see page 376)	<signal> ::= {FAIL PASS}
:MTEST:RMODE <rmode> (see page 377)	:MTEST:RMODE? (see page 377)	<rmode> ::= {FOREver TIME SIGMa WAVEforms}

Table 16 :MTESt Commands Summary (continued)

Command	Query	Options and Query Returns
:MTESt:RMODE:FACTION:MEASure {{0 OFF} {1 ON}} (see page 378)	:MTESt:RMODE:FACTION:MEASure? (see page 378)	{0 1}
:MTESt:RMODE:FACTION:PRINT {{0 OFF} {1 ON}} (see page 379)	:MTESt:RMODE:FACTION:PRINT? (see page 379)	{0 1}
:MTESt:RMODE:FACTION:SAVE {{0 OFF} {1 ON}} (see page 380)	:MTESt:RMODE:FACTION:SAVE? (see page 380)	{0 1}
:MTESt:RMODE:FACTION:STOP {{0 OFF} {1 ON}} (see page 381)	:MTESt:RMODE:FACTION:STOP? (see page 381)	{0 1}
:MTESt:RMODE:SIGMa <level> (see page 382)	:MTESt:RMODE:SIGMa? (see page 382)	<level> ::= from 0.1 to 9.3 in NR3 format
:MTESt:RMODE:TIME <seconds> (see page 383)	:MTESt:RMODE:TIME? (see page 383)	<seconds> ::= from 1 to 86400 in NR3 format
:MTESt:RMODE:WAVeform s <count> (see page 384)	:MTESt:RMODE:WAVeform s? (see page 384)	<count> ::= number of waveforms in NR1 format
:MTESt:SCALE:BIND {{0 OFF} {1 ON}} (see page 385)	:MTESt:SCALE:BIND? (see page 385)	{0 1}
:MTESt:SCALE:X1 <x1_value> (see page 386)	:MTESt:SCALE:X1? (see page 386)	<x1_value> ::= X1 value in NR3 format
:MTESt:SCALE:XDELta <xdelta_value> (see page 387)	:MTESt:SCALE:XDELta? (see page 387)	<xdelta_value> ::= X delta value in NR3 format
:MTESt:SCALE:Y1 <y1_value> (see page 388)	:MTESt:SCALE:Y1? (see page 388)	<y1_value> ::= Y1 value in NR3 format
:MTESt:SCALE:Y2 <y2_value> (see page 389)	:MTESt:SCALE:Y2? (see page 389)	<y2_value> ::= Y2 value in NR3 format

4 Commands Quick Reference

Table 16 :MTESt Commands Summary (continued)

Command	Query	Options and Query Returns
:MTESt:SOURce <source> (see page 390)	:MTESt:SOURce? (see page 390)	<source> ::= {CHANnel<n> NONE} <n> ::= {1 2 3 4} for 4ch models <n> ::= {1 2} for 2ch models
n/a	:MTESt:TITLe? (see page 391)	<title> ::= a string of up to 128 ASCII characters

Table 17 :POD<n> Commands Summary

Command	Query	Options and Query Returns
:POD<n>:DISPlay {{0 OFF} {1 ON}} (see page 393)	:POD<n>:DISPlay? (see page 393)	{0 1} <n> ::= 1-2 in NR1 format
:POD<n>:SIZE <value> (see page 394)	:POD<n>:SIZE? (see page 394)	<value> ::= {SMALl MEDium LARGe}
:POD<n>:THReshold <type>[suffix] (see page 395)	:POD<n>:THReshold? (see page 395)	<n> ::= 1-2 in NR1 format <type> ::= {CMOS ECL TTL <user defined value>} <user defined value> ::= value in NR3 format [suffix] ::= {V mV uV }

Table 18 :RECall Commands Summary

Command	Query	Options and Query Returns
:RECall:FIleName <base_name> (see page 398)	:RECall:FIleName? (see page 398)	<base_name> ::= quoted ASCII string
:RECall:IMAGe[:START] [<file_spec>] (see page 399)	n/a	<file_spec> ::= {<internal_loc> <file_name>} <internal_loc> ::= 0-9; an integer in NR1 format <file_name> ::= quoted ASCII string
:RECall:MASK[:START] [<file_spec>] (see page 400)	n/a	<file_spec> ::= {<internal_loc> <file_name>} <internal_loc> ::= 0-3; an integer in NR1 format <file_name> ::= quoted ASCII string

Table 18 :RECall Commands Summary (continued)

Command	Query	Options and Query Returns
:RECall:PWD <path_name> (see page 401)	:RECall:PWD? (see page 401)	<path_name> ::= quoted ASCII string
:RECall:SETup[:START] [<file_spec>] (see page 402)	n/a	<file_spec> ::= {<internal_loc> <file_name>} <internal_loc> ::= 0-9; an integer in NR1 format <file_name> ::= quoted ASCII string

Table 19 :SAVE Commands Summary

Command	Query	Options and Query Returns
:SAVE:FILEname <base_name> (see page 405)	:SAVE:FILEname? (see page 405)	<base_name> ::= quoted ASCII string
:SAVE:IMAGe[:START] [<file_spec>] (see page 406)	n/a	<file_spec> ::= {<internal_loc> <file_name>} <internal_loc> ::= 0-9; an integer in NR1 format <file_name> ::= quoted ASCII string
n/a	:SAVE:IMAGe:AREA? (see page 407)	<area> ::= {GRAT SCR}
:SAVE:IMAGe:FACTors {0 OFF} {1 ON} (see page 408)	:SAVE:IMAGe:FACTors? (see page 408)	{0 1}
:SAVE:IMAGe:FORMat <format> (see page 409)	:SAVE:IMAGe:FORMat? (see page 409)	<format> ::= {TIFF {BMP BMP24bit} BMP8bit PNG NONE}
:SAVE:IMAGe:INKSaver {0 OFF} {1 ON} (see page 410)	:SAVE:IMAGe:INKSaver? (see page 410)	{0 1}
:SAVE:IMAGe:PALette <palette> (see page 411)	:SAVE:IMAGe:PALette? (see page 411)	<palette> ::= {COLor GRAYscale MONochrome}
:SAVE:LISTer[:START] [<file_name>] (see page 412)	n/a	<file_name> ::= quoted ASCII string

4 Commands Quick Reference

Table 19 :SAVE Commands Summary (continued)

Command	Query	Options and Query Returns
:SAVE:MASK[:START] [<file_spec>] (see page 413)	n/a	<file_spec> ::= {<internal_loc> <file_name>} <internal_loc> ::= 0-3; an integer in NR1 format <file_name> ::= quoted ASCII string
:SAVE:PWD <path_name> (see page 414)	:SAVE:PWD? (see page 414)	<path_name> ::= quoted ASCII string
:SAVE:SETup[:START] [<file_spec>] (see page 415)	n/a	<file_spec> ::= {<internal_loc> <file_name>} <internal_loc> ::= 0-9; an integer in NR1 format <file_name> ::= quoted ASCII string
:SAVE:WAVEform[:START] [<file_name>] (see page 416)	n/a	<file_name> ::= quoted ASCII string
:SAVE:WAVEform:FORMat <format> (see page 417)	:SAVE:WAVEform:FORMat ? (see page 417)	<format> ::= {ALB ASCIixy CSV BINary NONE}
:SAVE:WAVEform:LENGth <length> (see page 418)	:SAVE:WAVEform:LENGth ? (see page 418)	<length> ::= 100 to max. length; an integer in NR1 format
:SAVE:WAVEform:SEGMent <option> (see page 419)	:SAVE:WAVEform:SEGMent? (see page 419)	<option> ::= {ALL CURRent}

Table 20 :SBUS Commands Summary

Command	Query	Options and Query Returns
n/a	:SBUS:CAN:COUNT:ERRor ? (see page 422)	<frame_count> ::= integer in NR1 format
n/a	:SBUS:CAN:COUNT:OVERload? (see page 423)	<frame_count> ::= integer in NR1 format
:SBUS:CAN:COUNT:RESet (see page 424)	n/a	n/a
n/a	:SBUS:CAN:COUNT:TOTal ? (see page 425)	<frame_count> ::= integer in NR1 format

Table 20 :SBUS Commands Summary (continued)

Command	Query	Options and Query Returns
n/a	:SBUS:CAN:COUNT:UTILiZation? (see page 426)	<percent> ::= floating-point in NR3 format
:SBUS:DISPlay {{0 OFF} {1 ON}} (see page 427)	:SBUS:DISPlay? (see page 427)	{0 1}
n/a	:SBUS:FLEXray:COUNT:NULL? (see page 428)	<frame_count> ::= integer in NR1 format
:SBUS:FLEXray:COUNT:RESet (see page 429)	n/a	n/a
n/a	:SBUS:FLEXray:COUNT:SYNC? (see page 430)	<frame_count> ::= integer in NR1 format
n/a	:SBUS:FLEXray:COUNT:TOTAL? (see page 431)	<frame_count> ::= integer in NR1 format
:SBUS:I2S:BASE <base> (see page 432)	:SBUS:I2S:BASE? (see page 432)	<base> ::= {DECimal HEX}
:SBUS:IIC:ASize <size> (see page 433)	:SBUS:IIC:ASIZE? (see page 433)	<size> ::= {BIT7 BIT8}
:SBUS:LIN:PARity {{0 OFF} {1 ON}} (see page 434)	:SBUS:LIN:PARity? (see page 434)	{0 1}
:SBUS:M1553:BASE <base> (see page 435)	:SBUS:M1553:BASE? (see page 435)	<base> ::= {DECimal HEX}
:SBUS:MODE <mode> (see page 436)	:SBUS:MODE? (see page 436)	<mode> ::= {CAN FLEXray I2S IIC LIN SPI UART}
:SBUS:SPI:BITorder <order> (see page 437)	:SBUS:SPI:BITorder? (see page 437)	<order> ::= {LSBFirst MSBFirst}
:SBUS:SPI:WIDTh <word_width> (see page 438)	:SBUS:SPI:WIDTh? (see page 438)	<word_width> ::= integer 4-16 in NR1 format
:SBUS:UART:BASE <base> (see page 439)	:SBUS:UART:BASE? (see page 439)	<base> ::= {ASCii BINary HEX}
n/a	:SBUS:UART:COUNT:ERROr? (see page 440)	<frame_count> ::= integer in NR1 format
:SBUS:UART:COUNT:RESet (see page 441)	n/a	n/a
n/a	:SBUS:UART:COUNT:RXFRames? (see page 442)	<frame_count> ::= integer in NR1 format

4 Commands Quick Reference

Table 20 :SBUS Commands Summary (continued)

Command	Query	Options and Query Returns
n/a	:SBUS:UART:COUNT:TXFRAMES? (see page 443)	<frame_count> ::= integer in NR1 format
:SBUS:UART:FRAMing <value> (see page 444)	:SBUS:UART:FRAMing? (see page 444)	<value> ::= {OFF <decimal> <nondecimal>} <decimal> ::= 8-bit integer from 0-255 (0x00-0xff) <nondecimal> ::= #Hnn where n ::= {0,...,9 A,...,F} for hexadecimal <nondecimal> ::= #Bnn...n where n ::= {0 1} for binary

Table 21 :SYSTem Commands Summary

Command	Query	Options and Query Returns
:SYSTem:DATE <date> (see page 446)	:SYSTem:DATE? (see page 446)	<date> ::= <year>,<month>,<day> <year> ::= 4-digit year in NR1 format <month> ::= {1,...,12 JANuary FEBruary MARch APRil MAY JUNE JULy AUGust SEPtember OCTober NOVember DECember} <day> ::= {1,..31}
:SYSTem:DSP <string> (see page 447)	n/a	<string> ::= up to 254 characters as a quoted ASCII string
n/a	:SYSTem:ERRor? (see page 448)	<error> ::= an integer error code <error string> ::= quoted ASCII string. See Error Messages (see page 743).
:SYSTem:LOCK <value> (see page 449)	:SYSTem:LOCK? (see page 449)	<value> ::= {{1 ON} {0 OFF}}
:SYSTem:PRECIion <value> (see page 450)	:SYSTem:PRECIion? (see page 450)	<value> ::= {{1 ON} {0 OFF}}
:SYSTem:PROTection:LOCK <value> (see page 451)	:SYSTem:PROTection:LOCK? (see page 451)	<value> ::= {{1 ON} {0 OFF}}

Table 21 :SYSTEM Commands Summary (continued)

Command	Query	Options and Query Returns
:SYSTEM:SETup <setup_data> (see page 452)	:SYSTEM:SETup? (see page 452)	<setup_data> ::= data in IEEE 488.2 # format.
:SYSTEM:TIME <time> (see page 454)	:SYSTEM:TIME? (see page 454)	<time> ::= hours, minutes, seconds in NR1 format

Table 22 :TIMEbase Commands Summary

Command	Query	Options and Query Returns
:TIMEbase:MODE <value> (see page 457)	:TIMEbase:MODE? (see page 457)	<value> ::= {MAIN WINDOW XY ROLL}
:TIMEbase:POSition <pos> (see page 458)	:TIMEbase:POSition? (see page 458)	<pos> ::= time from the trigger event to the display reference point in NR3 format
:TIMEbase:RANGe <range_value> (see page 459)	:TIMEbase:RANGe? (see page 459)	<range_value> ::= 5 ns through 500 s in NR3 format
:TIMEbase:REFClock {{0 OFF} {1 ON}} (see page 460)	:TIMEbase:REFClock? (see page 460)	{0 1}
:TIMEbase:REFERence {LEFT CENTER RIGHT} (see page 461)	:TIMEbase:REFERence? (see page 461)	<return_value> ::= {LEFT CENTER RIGHT}
:TIMEbase:SCALe <scale_value> (see page 462)	:TIMEbase:SCALe? (see page 462)	<scale_value> ::= scale value in seconds in NR3 format
:TIMEbase:VERNier {{0 OFF} {1 ON}} (see page 463)	:TIMEbase:VERNier? (see page 463)	{0 1}
:TIMEbase:WINDOW:POSi tion <pos> (see page 464)	:TIMEbase:WINDOW:POSi tion? (see page 464)	<pos> ::= time from the trigger event to the zoomed view reference point in NR3 format
:TIMEbase:WINDOW:RANG e <range_value> (see page 465)	:TIMEbase:WINDOW:RANG e? (see page 465)	<range value> ::= range value in seconds in NR3 format for the zoomed window
:TIMEbase:WINDOW:SCAL e <scale_value> (see page 466)	:TIMEbase:WINDOW:SCAL e? (see page 466)	<scale_value> ::= scale value in seconds in NR3 format for the zoomed window

4 Commands Quick Reference

Table 23 General :TRIGger Commands Summary

Command	Query	Options and Query Returns
:TRIGger:HFReject {{0 OFF}} {{1 ON}} (see page 471)	:TRIGger:HFReject? (see page 471)	{0 1}
:TRIGger:HOLDoff <holdoff_time> (see page 472)	:TRIGger:HOLDoff? (see page 472)	<holdoff_time> ::= 60 ns to 10 s in NR3 format
:TRIGger:MODE <mode> (see page 473)	:TRIGger:MODE? (see page 473)	<mode> ::= {EDGE GLITCh PATtern CAN DURation I2S IIC EBURst LIN M1553 SEquence SPI TV UART USB FLEXray} <return_value> ::= {<mode> <none>} <none> ::= query returns "NONE" if the :TIMEbase:MODE is ROLL or XY
:TRIGger:NREJect {{0 OFF}} {{1 ON}} (see page 474)	:TRIGger:NREJect? (see page 474)	{0 1}
:TRIGger:PATtern <value>, <mask> [, <edge source>, <edge>] (see page 475)	:TRIGger:PATtern? (see page 476)	<value> ::= integer in NR1 format or <string> <mask> ::= integer in NR1 format or <string> <string> ::= "0xnxxxx"; n ::= {0,...,9 A,...,F} (# bits = # channels) <edge source> ::= {CHANnel<n> EXTernal NONE} for DSO models <edge source> ::= {CHANnel<n> DIGital0,...,DIGital15 NONE} for MSO models <edge> ::= {POSitive NEGative} <n> ::= 1-2 or 1-4 in NR1 format
:TRIGger:SWEep <sweep> (see page 477)	:TRIGger:SWEep? (see page 477)	<sweep> ::= {AUTO NORMal}

Table 24 :TRIGger:CAN Commands Summary

Command	Query	Options and Query Returns
:TRIGger:CAN:PATtern:DATA <value>, <mask> (see page 480)	:TRIGger:CAN:PATtern:DATA? (see page 480)	<value> ::= 64-bit integer in decimal, <nondecimal>, or <string> (with Option AMS) <mask> ::= 64-bit integer in decimal, <nondecimal>, or <string> <nondecimal> ::= #Hnn...n where n ::= {0,...,9 A,...,F} for hexadecimal <nondecimal> ::= #Bnn...n where n ::= {0 1} for binary <string> ::= "0xnn...n" where n ::= {0,...,9 A,...,F} for hexadecimal
:TRIGger:CAN:PATtern:DATA:LENGth <length> (see page 481)	:TRIGger:CAN:PATtern:DATA:LENGth? (see page 481)	<length> ::= integer from 1 to 8 in NR1 format (with Option AMS)
:TRIGger:CAN:PATtern:ID <value>, <mask> (see page 482)	:TRIGger:CAN:PATtern:ID? (see page 482)	<value> ::= 32-bit integer in decimal, <nondecimal>, or <string> (with Option AMS) <mask> ::= 32-bit integer in decimal, <nondecimal>, or <string> <nondecimal> ::= #Hnn...n where n ::= {0,...,9 A,...,F} for hexadecimal <nondecimal> ::= #Bnn...n where n ::= {0 1} for binary <string> ::= "0xnn...n" where n ::= {0,...,9 A,...,F} for hexadecimal
:TRIGger:CAN:PATtern:ID:MODE <value> (see page 483)	:TRIGger:CAN:PATtern:ID:MODE? (see page 483)	<value> ::= {STANdard EXTended} (with Option AMS)
:TRIGger:CAN:SAMplepo int <value> (see page 484)	:TRIGger:CAN:SAMplepo int? (see page 484)	<value> ::= {60 62.5 68 70 75 80 87.5} in NR3 format
:TRIGger:CAN:SIGNAL:BAUDrate <baudrate> (see page 485)	:TRIGger:CAN:SIGNAL:BAUDrate? (see page 485)	<baudrate> ::= integer from 10000 to 1000000 in 100 b/s increments

4 Commands Quick Reference

Table 24 :TRIGger:CAN Commands Summary (continued)

Command	Query	Options and Query Returns
:TRIGger:CAN:SOURce <source> (see page 486)	:TRIGger:CAN:SOURce? (see page 486)	<source> ::= {CHANnel<n> EXTErnal} for DSO models <source> ::= {CHANnel<n> DIGital0,...,DIGital15 } for MSO models <n> ::= 1-2 or 1-4 in NR1 format
:TRIGger:CAN:TRIGger <condition> (see page 487)	:TRIGger:CAN:TRIGger? (see page 488)	<condition> ::= {SOF} (without Option AMS) <condition> ::= {SOF DATA ERRor IDData IDEither IDRemote ALLerrors OVERload ACKerror} (with Option AMS)

Table 25 :TRIGger:DURation Commands Summary

Command	Query	Options and Query Returns
:TRIGger:DURation:GREaterthan <greater than time>[suffix] (see page 490)	:TRIGger:DURation:GREaterthan? (see page 490)	<greater_than_time> ::= floating-point number in NR3 format [suffix] ::= {s ms us ns ps}
:TRIGger:DURation:LESSthan <less than time>[suffix] (see page 491)	:TRIGger:DURation:LESSthan? (see page 491)	<less_than_time> ::= floating-point number from in NR3 format [suffix] ::= {s ms us ns ps}
:TRIGger:DURation:PATtern <value>, <mask> (see page 492)	:TRIGger:DURation:PATtern? (see page 492)	<value> ::= integer or <string> <mask> ::= integer or <string> <string> ::= "0xnmmmmn" n ::= {0,...,9 A,...,F}
:TRIGger:DURation:QUALifier <qualifier> (see page 493)	:TRIGger:DURation:QUALifier? (see page 493)	<qualifier> ::= {GREaterthan LESSthan INRange OUTRange TIMEout}
:TRIGger:DURation:RANGe <less_than_time>[suffix], <greater_than_time>[suffix] (see page 494)	:TRIGger:DURation:RANGe? (see page 494)	<less_than_time> ::= 15 ns to 10 seconds in NR3 format <greater_than_time> ::= 10 ns to 9.99 seconds in NR3 format [suffix] ::= {s ms us ns ps}

Table 26 :TRIGger:EBURst Commands Summary

Command	Query	Options and Query Returns
:TRIGger:EBURst:COUNT <count> (see page 496)	:TRIGger:EBURst:COUNT ? (see page 496)	<count> ::= integer in NR1 format
:TRIGger:EBURst:IDLE <time_value> (see page 497)	:TRIGger:EBURst:IDLE? (see page 497)	<time_value> ::= time in seconds in NR3 format
:TRIGger:EBURst:SLOPe <slope> (see page 498)	:TRIGger:EBURst:SLOPe ? (see page 498)	<slope> ::= {NEGative POSitive}

Table 27 :TRIGger[:EDGE] Commands Summary

Command	Query	Options and Query Returns
:TRIGger[:EDGE]:COUPl ing {AC DC LF} (see page 500)	:TRIGger[:EDGE]:COUPl ing? (see page 500)	{AC DC LF}
:TRIGger[:EDGE]:LEVEl <level> [, <source>] (see page 501)	:TRIGger[:EDGE]:LEVEl ? [<source>] (see page 501)	For internal triggers, <level> ::= .75 x full-scale voltage from center screen in NR3 format. For external triggers, <level> ::= ±(external range setting) in NR3 format. For digital channels (MSO models), <level> ::= ±8 V. <source> ::= {CHANnel<n> EXTernal} for DSO models <source> ::= {CHANnel<n> DIGital0,...,DIGital15 EXTernal } for MSO models <n> ::= 1-2 or 1-4 in NR1 format
:TRIGger[:EDGE]:REJec t {OFF LF HF} (see page 502)	:TRIGger[:EDGE]:REJec t? (see page 502)	{OFF LF HF}
:TRIGger[:EDGE]:SLOPe <polarity> (see page 503)	:TRIGger[:EDGE]:SLOPe ? (see page 503)	<polarity> ::= {POSitive NEGative EITHer ALTernate}
:TRIGger[:EDGE]:SOURc e <source> (see page 504)	:TRIGger[:EDGE]:SOURc e? (see page 504)	<source> ::= {CHANnel<n> EXTernal} for DSO models <source> ::= {CHANnel<n> DIGital0,...,DIGital15 EXTernal} for MSO models <n> ::= 1-2 or 1-4 in NR1 format

4 Commands Quick Reference

Table 28 :TRIGger:FLEXray Commands Summary

Command	Query	Options and Query Returns
:TRIGger:FLEXray:AUTOsetup (see page 506)	n/a	n/a
:TRIGger:FLEXray:BAUDrate <baudrate> (see page 507)	:TRIGger:FLEXray:BAUDrate? (see page 507)	<baudrate> ::= {2500000 5000000 10000000}
:TRIGger:FLEXray:CHANnel <channel> (see page 508)	:TRIGger:FLEXray:CHANnel? (see page 508)	<channel> ::= {A B}
:TRIGger:FLEXray:ERRor:TYPE <error_type> (see page 509)	:TRIGger:FLEXray:ERRor:TYPE? (see page 509)	<error_type> ::= {ALL HCRC FCRC}
:TRIGger:FLEXray:EVENT:TYPE <event> (see page 510)	:TRIGger:FLEXray:EVENT:TYPE? (see page 510)	<event> ::= {WAKEup TSS {FES DTS} BSS}
:TRIGger:FLEXray:FRAME:CCBase <cycle_count_base> (see page 511)	:TRIGger:FLEXray:FRAME:CCBase? (see page 511)	<cycle_count_base> ::= integer from 0-63
:TRIGger:FLEXray:FRAME:CCRepetition <cycle_count_repetition> (see page 512)	:TRIGger:FLEXray:FRAME:CCRepetition? (see page 512)	<cycle_count_repetition> ::= {ALL <rep #>} <rep #> ::= integer from 2-64
:TRIGger:FLEXray:FRAME:ID <frame_id> (see page 513)	:TRIGger:FLEXray:FRAME:ID? (see page 513)	<frame_id> ::= {ALL <frame #>} <frame #> ::= integer from 1-2047
:TRIGger:FLEXray:FRAME:TYPE <frame_type> (see page 514)	:TRIGger:FLEXray:FRAME:TYPE? (see page 514)	<frame_type> ::= {NORMAL STARTup NULL SYNC NSTArtup NNULL NSYNc ALL}
:TRIGger:FLEXray:SOURce <source> (see page 515)	:TRIGger:FLEXray:SOURce? (see page 515)	<source> ::= {CHANnel<n>} <n> ::= 1-2 or 1-4 in NR1 format
:TRIGger:FLEXray:TRIGger <condition> (see page 516)	:TRIGger:FLEXray:TRIGger? (see page 516)	<condition> ::= {FRAME ERRor EVENT}

Table 29 :TRIGger:GLITCh Commands Summary

Command	Query	Options and Query Returns
:TRIGger:GLITCh:GREAt erthan <greater_than_time>[s uffix] (see page 519)	:TRIGger:GLITCh:GREAt erthan? (see page 519)	<greater_than_time> ::= floating-point number in NR3 format [suffix] ::= {s ms us ns ps}
:TRIGger:GLITCh:LESSt han <less_than_time>[suff ix] (see page 520)	:TRIGger:GLITCh:LESSt han? (see page 520)	<less_than_time> ::= floating-point number in NR3 format [suffix] ::= {s ms us ns ps}
:TRIGger:GLITCh:LEVel <level> [<source>] (see page 521)	:TRIGger:GLITCh:LEVel ? (see page 521)	For internal triggers, <level> ::= .75 x full-scale voltage from center screen in NR3 format. For external triggers (DSO models), <level> ::= ±(external range setting) in NR3 format. For digital channels (MSO models), <level> ::= ±8 V. <source> ::= {CHANnel<n> EXTErnal} for DSO models <source> ::= {CHANnel<n> DIGital0,...,DIGital15} for MSO models <n> ::= 1-2 or 1-4 in NR1 format
:TRIGger:GLITCh:POLar ity <polarity> (see page 522)	:TRIGger:GLITCh:POLar ity? (see page 522)	<polarity> ::= {POSitive NEGative}
:TRIGger:GLITCh:QUALi fier <qualifier> (see page 523)	:TRIGger:GLITCh:QUALi fier? (see page 523)	<qualifier> ::= {GREAterthan LESSthan RANGE}
:TRIGger:GLITCh:RANGe <less_than_time>[suff ix], <greater_than_time>[s uffix] (see page 524)	:TRIGger:GLITCh:RANGe ? (see page 524)	<less_than_time> ::= 15 ns to 10 seconds in NR3 format <greater_than_time> ::= 10 ns to 9.99 seconds in NR3 format [suffix] ::= {s ms us ns ps}
:TRIGger:GLITCh:SOURc e <source> (see page 525)	:TRIGger:GLITCh:SOURc e? (see page 525)	<source> ::= {CHANnel<n> EXTErnal} for DSO models <source> ::= {CHANnel<n> DIGital0,...,DIGital15 } for MSO models <n> ::= 1-2 or 1-4 in NR1 format

4 Commands Quick Reference

Table 30 :TRIGger:I2S Commands Summary

Command	Query	Options and Query Returns
:TRIGger:I2S:ALIGnment <setting> (see page 528)	:TRIGger:I2S:ALIGnment? (see page 528)	<setting> ::= {I2S LJ RJ}
:TRIGger:I2S:AUDio <audio_ch> (see page 529)	:TRIGger:I2S:AUDio? (see page 529)	<audio_ch> ::= {RIGHT LEFT EITHER}
:TRIGger:I2S:CLOCK:SLOPe <slope> (see page 530)	:TRIGger:I2S:CLOCK:SLOPe? (see page 530)	<slope> ::= {NEGative POSitive}
:TRIGger:I2S:PATtern:DATA <string> (see page 531)	:TRIGger:I2S:PATtern:DATA? (see page 532)	<string> ::= "n" where n ::= 32-bit integer in signed decimal when <base> = DECimal <string> ::= "nn...n" where n ::= {0 1 X \$} when <base> = BINary <string> ::= "0xnn...n" where n ::= {0,...,9 A,...,F X \$} when <base> = HEX
:TRIGger:I2S:PATtern:FORMat <base> (see page 533)	:TRIGger:I2S:PATtern:FORMat? (see page 533)	<base> ::= {BINary HEX DECimal}
:TRIGger:I2S:RANGe <upper>,<lower> (see page 534)	:TRIGger:I2S:RANGe? (see page 534)	<upper> ::= 32-bit integer in signed decimal, <nondecimal>, or <string> <lower> ::= 32-bit integer in signed decimal, <nondecimal>, or <string> <nondecimal> ::= #Hnn...n where n ::= {0,...,9 A,...,F} for hexadecimal <nondecimal> ::= #Bnn...n where n ::= {0 1} for binary <string> ::= "0xnn...n" where n ::= {0,...,9 A,...,F} for hexadecimal
:TRIGger:I2S:RWIDth <receiver> (see page 536)	:TRIGger:I2S:RWIDth? (see page 536)	<receiver> ::= 4-32 in NR1 format

Table 30 :TRIGger:I2S Commands Summary (continued)

Command	Query	Options and Query Returns
:TRIGger:I2S:SOURce:CLOCK <source> (see page 537)	:TRIGger:I2S:SOURce:CLOCK? (see page 537)	<source> ::= {CHANnel<n> EXTErnal} for DSO models <source> ::= {CHANnel<n> DIGital0,...,DIGital15 } for MSO models <n> ::= 1-2 or 1-4 in NR1 format
:TRIGger:I2S:SOURce:DATA <source> (see page 538)	:TRIGger:I2S:SOURce:DATA? (see page 538)	<source> ::= {CHANnel<n> EXTErnal} for DSO models <source> ::= {CHANnel<n> DIGital0,...,DIGital15 } for MSO models <n> ::= 1-2 or 1-4 in NR1 format
:TRIGger:I2S:SOURce:WSElect <source> (see page 539)	:TRIGger:I2S:SOURce:WSElect? (see page 539)	<source> ::= {CHANnel<n> EXTErnal} for DSO models <source> ::= {CHANnel<n> DIGital0,...,DIGital15 } for MSO models <n> ::= 1-2 or 1-4 in NR1 format
:TRIGger:I2S:TRIGger<operator> (see page 540)	:TRIGger:I2S:TRIGger? (see page 540)	<operator> ::= {EQUal NOTequal LESSthan GREATERthan INRange OUTRange INCRasing DECRasing}
:TRIGger:I2S:TWIDTH <word_size> (see page 542)	:TRIGger:I2S:TWIDTH? (see page 542)	<word_size> ::= 4-32 in NR1 format
:TRIGger:I2S:WSLow <low_def> (see page 543)	:TRIGger:I2S:WSLow? (see page 543)	<low_def> ::= {LEFT RIGHT}

Table 31 :TRIGger:IIC Commands Summary

Command	Query	Options and Query Returns
:TRIGger:IIC:PATtern:ADDRESS <value> (see page 545)	:TRIGger:IIC:PATtern:ADDRESS? (see page 545)	<value> ::= integer or <string> <string> ::= "0xnn" n ::= {0,...,9 A,...,F}
:TRIGger:IIC:PATtern:DATA <value> (see page 546)	:TRIGger:IIC:PATtern:DATA? (see page 546)	<value> ::= integer or <string> <string> ::= "0xnn" n ::= {0,...,9 A,...,F}
:TRIGger:IIC:PATtern:DATA2 <value> (see page 547)	:TRIGger:IIC:PATtern:DATA2? (see page 547)	<value> ::= integer or <string> <string> ::= "0xnn" n ::= {0,...,9 A,...,F}

4 Commands Quick Reference

Table 31 :TRIGger:IIC Commands Summary (continued)

Command	Query	Options and Query Returns
:TRIGger:IIC[:SOURce] :CLOCK <source> (see page 548)	:TRIGger:IIC[:SOURce] :CLOCK? (see page 548)	<source> ::= {CHANnel<n> EXTErnal} for DSO models <source> ::= {CHANnel<n> DIGital0,...,DIGital15 } for MSO models <n> ::= 1-2 or 1-4 in NR1 format
:TRIGger:IIC[:SOURce] :DATA <source> (see page 549)	:TRIGger:IIC[:SOURce] :DATA? (see page 549)	<source> ::= {CHANnel<n> EXTErnal} for DSO models <source> ::= {CHANnel<n> DIGital0,...,DIGital15 } for MSO models <n> ::= 1-2 or 1-4 in NR1 format
:TRIGger:IIC:TRIGger: QUALifier <value> (see page 550)	:TRIGger:IIC:TRIGger: QUALifier? (see page 550)	<value> ::= {EQUal NOTequal LESSthan GREATERthan}
:TRIGger:IIC:TRIGger[:TYPE] <type> (see page 551)	:TRIGger:IIC:TRIGger[:TYPE]? (see page 551)	<type> ::= {START STOP READ7 READEprom WRITe7 WRITe10 NACKnowledge ANACKnowledge R7Data2 W7Data2 REStart}

Table 32 :TRIGger:LIN Commands Summary

Command	Query	Options and Query Returns
:TRIGger:LIN:ID <value> (see page 555)	:TRIGger:LIN:ID? (see page 555)	<value> ::= 7-bit integer in decimal, <nondecimal>, or <string> from 0-63 or 0x00-0x3f (with Option AMS) <nondecimal> ::= #Hnn where n ::= {0,...,9 A,...,F} for hexadecimal <nondecimal> ::= #Bnn...n where n ::= {0 1} for binary <string> ::= "0xnn" where n ::= {0,...,9 A,...,F} for hexadecimal
:TRIGger:LIN:PATtern: DATA <string> (see page 556)	:TRIGger:LIN:PATtern: DATA? (see page 557)	<string> ::= "n" where n ::= 32-bit integer in signed decimal when <base> = DECimal <string> ::= "nn...n" where n ::= {0 1 X \$} when <base> = BINary <string> ::= "0xnn...n" where n ::= {0,...,9 A,...,F X \$} when <base> = HEX

Table 32 :TRIGger:LIN Commands Summary (continued)

Command	Query	Options and Query Returns
:TRIGger:LIN:PATtern:DATA:LENGth <length> (see page 558)	:TRIGger:LIN:PATtern:DATA:LENGth? (see page 558)	<length> ::= integer from 1 to 8 in NR1 format
:TRIGger:LIN:PATtern:FORMat <base> (see page 559)	:TRIGger:LIN:PATtern:FORMat? (see page 559)	<base> ::= {BINary HEX DECimal}
:TRIGger:LIN:SAMPlepo int <value> (see page 560)	:TRIGger:LIN:SAMPlepo int? (see page 560)	<value> ::= {60 62.5 68 70 75 80 87.5} in NR3 format
:TRIGger:LIN:SIGNAL:B AUDrate <baudrate> (see page 561)	:TRIGger:LIN:SIGNAL:B AUDrate? (see page 561)	<baudrate> ::= integer from 2400 to 625000 in 100 b/s increments
:TRIGger:LIN:SOURce <source> (see page 562)	:TRIGger:LIN:SOURce? (see page 562)	<source> ::= {CHANnel<n> EXTernal} for DSO models <source> ::= {CHANnel<n> DIGital0,...,DIGital15} for MSO models <n> ::= 1-2 or 1-4 in NR1 format
:TRIGger:LIN:STANdard <std> (see page 563)	:TRIGger:LIN:STANdard ? (see page 563)	<std> ::= {LIN13 LIN20}
:TRIGger:LIN:SYNCbrea k <value> (see page 564)	:TRIGger:LIN:SYNCbrea k? (see page 564)	<value> ::= integer = {11 12 13}
:TRIGger:LIN:TRIGger <condition> (see page 565)	:TRIGger:LIN:TRIGger? (see page 565)	<condition> ::= {SYNCbreak} (without Option AMS) <condition> ::= {SYNCbreak ID DATA} (with Option AMS)

Table 33 :TRIGger:M1553 Commands Summary

Command	Query	Options and Query Returns
:TRIGger:M1553:AUTOse tup (see page 567)	n/a	n/a
:TRIGger:M1553:PATtern:DATA <string> (see page 568)	:TRIGger:M1553:PATtern:DATA? (see page 568)	<string> ::= "nn...n" where n ::= {0 1 X}

4 Commands Quick Reference

Table 33 :TRIGger:M1553 Commands Summary (continued)

Command	Query	Options and Query Returns
:TRIGger:M1553:RTA <value> (see page 569)	:TRIGger:M1553:RTA? (see page 569)	<value> ::= 5-bit integer in decimal, <nondecimal>, or <string> from 0-31 <nondecimal> ::= #Hnn where n ::= {0,...,9 A,...,F} <string> ::= "0xnn" where n ::= {0,...,9 A,...,F}
:TRIGger:M1553:SOURce :LOWer <source> (see page 570)	:TRIGger:M1553:SOURce :LOWer? (see page 570)	<source> ::= {CHANnel<n>} <n> ::= {2 4}
:TRIGger:M1553:SOURce :UPPer <source> (see page 571)	:TRIGger:M1553:SOURce :UPPer? (see page 571)	<source> ::= {CHANnel<n>} <n> ::= {1 3}
:TRIGger:M1553:TYPE <type> (see page 572)	:TRIGger:M1553:TYPE? (see page 572)	<type> ::= {DStArt DStOp CStArt CStOp RTA PERRor SERRor MERRor RTA11}

Table 34 :TRIGger:SEQuence Commands Summary

Command	Query	Options and Query Returns
:TRIGger:SEQuence:COU Nt <count> (see page 574)	:TRIGger:SEQuence:COU Nt? (see page 574)	<count> ::= integer in NR1 format
:TRIGger:SEQuence:EDG E{1 2} <source>, <slope> (see page 575)	:TRIGger:SEQuence:EDG E{1 2}? (see page 575)	<source> ::= {CHANnel<n> EXtERnal} for the DSO models <source> ::= {CHANnel<n> DIGital0,...,DIGital15} for the MSO models <slope> ::= {POSitive NEGative} <n> ::= 1-2 or 1-4 in NR1 format <return_value> ::= query returns "NONE" if edge source is disabled
:TRIGger:SEQuence:FIN D <value> (see page 576)	:TRIGger:SEQuence:FIN D? (see page 576)	<value> ::= {PATtERn1,ENTERed PATtERn1,EXITed EDGE1 PATtERn1,AND,EDGE1}
:TRIGger:SEQuence:PAT Tern{1 2} <value>, <mask> (see page 577)	:TRIGger:SEQuence:PAT Tern{1 2}? (see page 577)	<value> ::= integer or <string> <mask> ::= integer or <string> <string> ::= "0xnxxxxn" n ::= {0,...,9 A,...,F}

Table 34 :TRIGger:SEquence Commands Summary (continued)

Command	Query	Options and Query Returns
:TRIGger:SEquence:RES et <value> (see page 578)	:TRIGger:SEquence:RES et? (see page 578)	<value> ::= {NONE PATtern1,ENTERed PATtern1,EXITed EDGE1 PATtern1,AND,EDGE1 PATtern2,ENTERed PATtern2,EXITed EDGE2 TIMER} Values used in find and trigger stages not available. EDGE2 not available if EDGE2,COUNT used in trigger stage.
:TRIGger:SEquence:TIMER <time_value> (see page 579)	:TRIGger:SEquence:TIMER? (see page 579)	<time_value> ::= time from 10 ns to 10 seconds in NR3 format
:TRIGger:SEquence:TRIGGER <value> (see page 580)	:TRIGger:SEquence:TRIGGER? (see page 580)	<value> ::= {PATtern2,ENTERed PATtern2,EXITed EDGE2 PATtern2,AND,EDGE2 EDGE2,COUNT EDGE2,COUNT,NREFind}

Table 35 :TRIGger:SPI Commands Summary

Command	Query	Options and Query Returns
:TRIGger:SPI:CLOCK:SLOPe <slope> (see page 582)	:TRIGger:SPI:CLOCK:SLOPe? (see page 582)	<slope> ::= {NEGative POSitive}
:TRIGger:SPI:CLOCK:TIMEout <time_value> (see page 583)	:TRIGger:SPI:CLOCK:TIMEout? (see page 583)	<time_value> ::= time in seconds in NR1 format
:TRIGger:SPI:FRAMing <value> (see page 584)	:TRIGger:SPI:FRAMing? (see page 584)	<value> ::= {CHIPselect NOTChipselect TIMEout}
:TRIGger:SPI:PATtern:DATA <value>, <mask> (see page 585)	:TRIGger:SPI:PATtern:DATA? (see page 585)	<value> ::= integer or <string> <mask> ::= integer or <string> <string> ::= "0xnxxxxx" where n ::= {0,...,9 A,...,F}
:TRIGger:SPI:PATtern:WIDTH <width> (see page 586)	:TRIGger:SPI:PATtern:WIDTH? (see page 586)	<width> ::= integer from 4 to 32 in NR1 format

4 Commands Quick Reference

Table 35 :TRIGger:SPI Commands Summary (continued)

Command	Query	Options and Query Returns
:TRIGger:SPI:SOURce:CLOCK <source> (see page 587)	:TRIGger:SPI:SOURce:CLOCK? (see page 587)	<value> ::= {CHANnel<n> EXTErnal} for the DSO models <value> ::= {CHANnel<n> DIGital0,..,DIGital15} for the MSO models <n> ::= 1-2 or 1-4 in NR1 format
:TRIGger:SPI:SOURce:DATA <source> (see page 588)	:TRIGger:SPI:SOURce:DATA? (see page 588)	<value> ::= {CHANnel<n> EXTErnal} for the DSO models <value> ::= {CHANnel<n> DIGital0,..,DIGital15} for the MSO models <n> ::= 1-2 or 1-4 in NR1 format
:TRIGger:SPI:SOURce:FRAME <source> (see page 589)	:TRIGger:SPI:SOURce:FRAME? (see page 589)	<value> ::= {CHANnel<n> EXTErnal} for the DSO models <value> ::= {CHANnel<n> DIGital0,..,DIGital15} for the MSO models <n> ::= 1-2 or 1-4 in NR1 format

Table 36 :TRIGger:TV Commands Summary

Command	Query	Options and Query Returns
:TRIGger:TV:LINE <line number> (see page 591)	:TRIGger:TV:LINE? (see page 591)	<line number> ::= integer in NR1 format
:TRIGger:TV:MODE <tv mode> (see page 592)	:TRIGger:TV:MODE? (see page 592)	<tv mode> ::= {FIEld1 FIEld2 AFIElds ALINes LINE VERTical LFIeld1 LFIeld2 LALternate LVERTical}
:TRIGger:TV:POLarity <polarity> (see page 593)	:TRIGger:TV:POLarity? (see page 593)	<polarity> ::= {POSitive NEGative}
:TRIGger:TV:SOURce <source> (see page 594)	:TRIGger:TV:SOURce? (see page 594)	<source> ::= {CHANnel<n>} <n> ::= 1-2 or 1-4 integer in NR1 format
:TRIGger:TV:STANdard <standard> (see page 595)	:TRIGger:TV:STANdard? (see page 595)	<standard> ::= {GENeric NTSC PALM PAL SECam {P480L60HZ P480} {P720L60HZ P720} {P1080L24HZ P1080} P1080L25HZ P1080L50HZ P1080L60HZ {I1080L50HZ I1080} I1080L60HZ}

Table 37 :TRIGger:UART Commands Summary

Command	Query	Options and Query Returns
:TRIGger:UART:BASE <base> (see page 598)	:TRIGger:UART:BASE? (see page 598)	<base> ::= {ASCIi HEX}
:TRIGger:UART:BAUDrate <baudrate> (see page 599)	:TRIGger:UART:BAUDrate? (see page 599)	<baudrate> ::= integer from 1200 to 3000000 in 100 b/s increments
:TRIGger:UART:BITorder <bitorder> (see page 600)	:TRIGger:UART:BITorder? (see page 600)	<bitorder> ::= {LSBFirst MSBFirst}
:TRIGger:UART:BURSt <value> (see page 601)	:TRIGger:UART:BURSt? (see page 601)	<value> ::= {OFF 1 to 4096 in NR1 format}
:TRIGger:UART:DATA <value> (see page 602)	:TRIGger:UART:DATA? (see page 602)	<value> ::= 8-bit integer from 0-255 (0x00-0xff) in decimal, <hexadecimal>, <binary>, or <quoted_string> format <hexadecimal> ::= #Hnn where n ::= {0,...,9 A,...,F} for hexadecimal <binary> ::= #Bnn...n where n ::= {0 1} for binary <quoted_string> ::= any of the 128 valid 7-bit ASCII characters (or standard abbreviations)
:TRIGger:UART:IDLE <time_value> (see page 603)	:TRIGger:UART:IDLE? (see page 603)	<time_value> ::= time from 1 us to 10 s in NR3 format
:TRIGger:UART:PARity <parity> (see page 604)	:TRIGger:UART:PARity? (see page 604)	<parity> ::= {EVEN ODD NONE}
:TRIGger:UART:POLarity <polarity> (see page 605)	:TRIGger:UART:POLarity? (see page 605)	<polarity> ::= {HIGH LOW}
:TRIGger:UART:QUALifier <value> (see page 606)	:TRIGger:UART:QUALifier? (see page 606)	<value> ::= {EQUAL NOTequal GREaterthan LESSthan}
:TRIGger:UART:SOURce: RX <source> (see page 607)	:TRIGger:UART:SOURce: RX? (see page 607)	<source> ::= {CHANnel<n> EXTernal} for DSO models <source> ::= {CHANnel<n> DIGital0,...,DIGital15} for MSO models <n> ::= 1-2 or 1-4 in NR1 format

4 Commands Quick Reference

Table 37 :TRIGger:UART Commands Summary (continued)

Command	Query	Options and Query Returns
:TRIGger:UART:SOURce:TX <source> (see page 608)	:TRIGger:UART:SOURce:TX? (see page 608)	<source> ::= {CHANnel<n> EXTErnal} for DSO models <source> ::= {CHANnel<n> DIGital0,...,DIGital15} for MSO models <n> ::= 1-2 or 1-4 in NR1 format
:TRIGger:UART:TYPE <value> (see page 609)	:TRIGger:UART:TYPE? (see page 609)	<value> ::= {RSTArt RSTOp RDATa RD1 RD0 RDX PARityerror TSTArt TSTOp TDATa TD1 TD0 TDX}
:TRIGger:UART:WIDTh <width> (see page 610)	:TRIGger:UART:WIDTh? (see page 610)	<width> ::= {5 6 7 8 9}

Table 38 :TRIGger:USB Commands Summary

Command	Query	Options and Query Returns
:TRIGger:USB:SOURce:D MINus <source> (see page 612)	:TRIGger:USB:SOURce:D MINus? (see page 612)	<source> ::= {CHANnel<n> EXTErnal} for the DSO models <source> ::= {CHANnel<n> DIGital0,...,DIGital15} for the MSO models <n> ::= 1-2 or 1-4 in NR1 format
:TRIGger:USB:SOURce:D Plus <source> (see page 613)	:TRIGger:USB:SOURce:D Plus? (see page 613)	<source> ::= {CHANnel<n> EXTErnal} for the DSO models <source> ::= {CHANnel<n> DIGital0,...,DIGital15} for the MSO models <n> ::= 1-2 or 1-4 in NR1 format
:TRIGger:USB:SPEEd <value> (see page 614)	:TRIGger:USB:SPEEd? (see page 614)	<value> ::= {LOW FULL}
:TRIGger:USB:TRIGger <value> (see page 615)	:TRIGger:USB:TRIGger? (see page 615)	<value> ::= {SOP EOP ENTersuspend EXITsuspend RESet}

Table 39 :WAVeform Commands Summary

Command	Query	Options and Query Returns
:WAVeform:BYTeorder <value> (see page 624)	:WAVeform:BYTeorder? (see page 624)	<value> ::= {LSBFirst MSBFirst}
n/a	:WAVeform:COUNT? (see page 625)	<count> ::= an integer from 1 to 65536 in NR1 format
n/a	:WAVeform:DATA? (see page 626)	<binary block length bytes>, <binary data> For example, to transmit 1000 bytes of data, the syntax would be: #800001000<1000 bytes of data><NL> 8 is the number of digits that follow 00001000 is the number of bytes to be transmitted <1000 bytes of data> is the actual data
:WAVeform:FORMat <value> (see page 628)	:WAVeform:FORMat? (see page 628)	<value> ::= {WORD BYTE ASCII}
:WAVeform:POINTs <# points> (see page 629)	:WAVeform:POINTs? (see page 629)	<# points> ::= {100 250 500 1000 <points_mode>} if waveform points mode is NORMAl <# points> ::= {100 250 500 1000 2000 ... 8000000 in 1-2-5 sequence <points_mode>} if waveform points mode is MAXimum or RAW <points_mode> ::= {NORMAl MAXimum RAW}
:WAVeform:POINTs:MODE <points_mode> (see page 631)	:WAVeform:POINTs:MODE ? (see page 632)	<points_mode> ::= {NORMAl MAXimum RAW}

Table 39 :WAVEform Commands Summary (continued)

Command	Query	Options and Query Returns
n/a	:WAVEform:PREamble? (see page 633)	<p><preamble_block> ::= <format NR1>, <type NR1>,<points NR1>,<count NR1>, <xincrement NR3>, <xorigin NR3>, <xreference NR1>,<yincrement NR3>, <yorigin NR3>, <yreference NR1></p> <p><format> ::= an integer in NR1 format:</p> <ul style="list-style-type: none"> • 0 for BYTE format • 1 for WORD format • 2 for ASCII format <p><type> ::= an integer in NR1 format:</p> <ul style="list-style-type: none"> • 0 for NORMAL type • 1 for PEAK detect type • 2 for AVERAGE type • 3 for HRESolution type <p><count> ::= Average count, or 1 if PEAK detect type or NORMAL; an integer in NR1 format</p>
n/a	:WAVEform:SEGmented:COUNT? (see page 636)	<count> ::= an integer from 2 to 2000 in NR1 format (with Option SGM)
n/a	:WAVEform:SEGmented:TAG? (see page 637)	<time_tag> ::= in NR3 format (with Option SGM)
:WAVEform:SOURce <source> (see page 638)	:WAVEform:SOURce? (see page 638)	<p><source> ::= {CHANnel<n> FUNCTION MATH SBUS} for DSO models</p> <p><source> ::= {CHANnel<n> POD{1 2} BUS{1 2} FUNCTION MATH SBUS} for MSO models</p> <p><n> ::= 1-2 or 1-4 in NR1 format</p>
:WAVEform:SOURce:SUBSource <subsource> (see page 642)	:WAVEform:SOURce:SUBSource? (see page 642)	<subsource> ::= {NONE RX} TX
n/a	:WAVEform:TYPE? (see page 643)	<return_mode> ::= {NORM PEAK AVER HRES}
:WAVEform:UNSigned {{0 OFF} {1 ON}} (see page 644)	:WAVEform:UNSigned? (see page 644)	{0 1}
:WAVEform:VIEW <view> (see page 645)	:WAVEform:VIEW? (see page 645)	<view> ::= {MAIN}

Table 39 :WAVeform Commands Summary (continued)

Command	Query	Options and Query Returns
n/a	:WAVeform:XINCrement? (see page 646)	<return_value> ::= x-increment in the current preamble in NR3 format
n/a	:WAVeform:XORigin? (see page 647)	<return_value> ::= x-origin value in the current preamble in NR3 format
n/a	:WAVeform:XREFerence? (see page 648)	<return_value> ::= 0 (x-reference value in the current preamble in NR1 format)
n/a	:WAVeform:YINCrement? (see page 649)	<return_value> ::= y-increment value in the current preamble in NR3 format
n/a	:WAVeform:YORigin? (see page 650)	<return_value> ::= y-origin in the current preamble in NR3 format
n/a	:WAVeform:YREFerence? (see page 651)	<return_value> ::= y-reference value in the current preamble in NR1 format

Syntax Elements

- "Number Format" on page 108
- "<NL> (Line Terminator)" on page 108
- "[] (Optional Syntax Terms)" on page 108
- "{ } (Braces)" on page 108
- "::<= (Defined As)" on page 108
- "< > (Angle Brackets)" on page 109
- "... (Ellipsis)" on page 109
- "n,...,p (Value Ranges)" on page 109
- "d (Digits)" on page 109
- "Quoted ASCII String" on page 109
- "Definite-Length Block Response Data" on page 109

Number Format

NR1 specifies integer data.

NR3 specifies exponential data in floating point format (for example, -1.0E-3).

<NL> (Line Terminator)

<NL> = new line or linefeed (ASCII decimal 10).

The line terminator, or a leading colon, will send the parser to the "root" of the command tree.

[] (Optional Syntax Terms)

Items enclosed in square brackets, [], are optional.

{ } (Braces)

When several items are enclosed by braces, { }, only one of these elements may be selected. Vertical line (|) indicates "or". For example, {ON | OFF} indicates that only ON or OFF may be selected, not both.

::= (Defined As)

::= means "defined as".

For example, <A> ::= indicates that <A> can be replaced by in any statement containing <A>.

< > (Angle Brackets)

< > Angle brackets enclose words or characters that symbolize a program code parameter or an interface command.

... (Ellipsis)

... An ellipsis (trailing dots) indicates that the preceding element may be repeated one or more times.

n,...,p (Value Ranges)

n,...,p ::= all integers between n and p inclusive.

d (Digits)

d ::= A single ASCII numeric character 0 - 9.

Quoted ASCII String

A quoted ASCII string is a string delimited by either double quotes (") or single quotes ('). Some command parameters require a quoted ASCII string. For example, when using the Agilent VISA COM library in Visual Basic, the command:

```
myScope.WriteString ":CHANNEL1:LABEL 'One'"
```

has a quoted ASCII string of:

```
'One'
```

In order to read quoted ASCII strings from query return values, some programming languages require special handling or syntax.

Definite-Length Block Response Data

Definite-length block response data allows any type of device-dependent data to be transmitted over the system interface as a series of 8-bit binary data bytes. This is particularly useful for sending large quantities of data or 8-bit extended ASCII codes. This syntax is a pound sign (#) followed by a non-zero digit representing the number of digits in the decimal integer. After the non-zero digit is the decimal integer that states the number of 8-bit data bytes being sent. This is followed by the actual data.

For example, for transmitting 1000 bytes of data, the syntax would be

4 Commands Quick Reference

#800001000<1000 bytes of data> <NL>

8 is the number of digits that follow

00001000 is the number of bytes to be transmitted

<1000 bytes of data> is the actual data

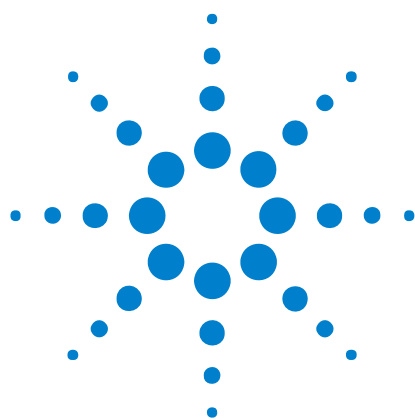

5 Commands by Subsystem

Subsystem	Description
"Common (*) Commands" on page 113	Commands defined by IEEE 488.2 standard that are common to all instruments.
"Root (:) Commands" on page 139	Control many of the basic functions of the oscilloscope and reside at the root level of the command tree.
":ACQuire Commands" on page 181	Set the parameters for acquiring and storing data.
":BUS<n> Commands" on page 198	Control all oscilloscope functions associated with the digital channels bus display.
":CALibrate Commands" on page 207	Utility commands for determining the state of the calibration factor protection switch.
":CHANnel<n> Commands" on page 217	Control all oscilloscope functions associated with individual analog channels or groups of channels.
":DIGital<n> Commands" on page 237	Control all oscilloscope functions associated with individual digital channels.
":DISPlay Commands" on page 244	Control how waveforms, graticule, and text are displayed and written on the screen.
":EXTernal Trigger Commands" on page 254	Control the input characteristics of the external trigger input.
":FUNction Commands" on page 264	Control functions in the measurement/storage module.
":HARDcopy Commands" on page 281	Set and query the selection of hardcopy device and formatting options.
":LISTer Commands" on page 292	Turn on/off the Lister display for decoded serial data and get the Lister data.
":MARKer Commands" on page 295	Set and query the settings of X-axis markers (X1 and X2 cursors) and the Y-axis markers (Y1 and Y2 cursors).



Subsystem	Description
":MEASure Commands" on page 306	Select automatic measurements to be made and control time markers.
":MTESt Commands" on page 358	Control the mask test features provided with Option LMT.
":POD Commands" on page 392	Control all oscilloscope functions associated with groups of digital channels.
":RECall Commands" on page 397	Recall previously saved oscilloscope setups and traces.
":SAVE Commands" on page 403	Save oscilloscope setups and traces, screen images, and data.
":SBUS Commands" on page 420	Control oscilloscope functions associated with the serial decode bus.
":SYSTem Commands" on page 445	Control basic system functions of the oscilloscope.
":TIMEbase Commands" on page 455	Control all horizontal sweep functions.
":TRIGger Commands" on page 467	Control the trigger modes and parameters for each trigger type.
":WAVEform Commands" on page 616	Provide access to waveform data.

Command Types Three types of commands are used:

- **Common (*) Commands** – See ["Introduction to Common \(*\) Commands" on page 116](#) for more information.
- **Root Level (:) Commands** – See ["Introduction to Root \(: \) Commands" on page 141](#) for more information.
- **Subsystem Commands** – Subsystem commands are grouped together under a common node of the ["Command Tree" on page 791](#), such as the :TIMEbase commands. Only one subsystem may be selected at any given time. When the instrument is initially turned on, the command parser is set to the root of the command tree; therefore, no subsystem is selected.

Common (*) Commands

Commands defined by IEEE 488.2 standard that are common to all instruments. See "Introduction to Common (*) Commands" on page 116.

Table 40 Common (*) Commands Summary

Command	Query	Options and Query Returns																																				
*CLS (see page 117)	n/a	n/a																																				
*ESE <mask> (see page 118)	*ESE? (see page 119)	<p><mask> ::= 0 to 255; an integer in NR1 format:</p> <table border="1"> <thead> <tr> <th>Bit</th> <th>Weight</th> <th>Name</th> <th>Enables</th> </tr> </thead> <tbody> <tr> <td>7</td> <td>128</td> <td>PON</td> <td>Power On</td> </tr> <tr> <td>6</td> <td>64</td> <td>URQ</td> <td>User Request</td> </tr> <tr> <td>5</td> <td>32</td> <td>CME</td> <td>Command Error</td> </tr> <tr> <td>4</td> <td>16</td> <td>EXE</td> <td>Execution Error</td> </tr> <tr> <td>3</td> <td>8</td> <td>DDE</td> <td>Dev. Dependent Error</td> </tr> <tr> <td>2</td> <td>4</td> <td>QYE</td> <td>Query Error</td> </tr> <tr> <td>1</td> <td>2</td> <td>RQL</td> <td>Request Control</td> </tr> <tr> <td>0</td> <td>1</td> <td>OPC</td> <td>Operation Complete</td> </tr> </tbody> </table>	Bit	Weight	Name	Enables	7	128	PON	Power On	6	64	URQ	User Request	5	32	CME	Command Error	4	16	EXE	Execution Error	3	8	DDE	Dev. Dependent Error	2	4	QYE	Query Error	1	2	RQL	Request Control	0	1	OPC	Operation Complete
Bit	Weight	Name	Enables																																			
7	128	PON	Power On																																			
6	64	URQ	User Request																																			
5	32	CME	Command Error																																			
4	16	EXE	Execution Error																																			
3	8	DDE	Dev. Dependent Error																																			
2	4	QYE	Query Error																																			
1	2	RQL	Request Control																																			
0	1	OPC	Operation Complete																																			
n/a	*ESR? (see page 120)	<status> ::= 0 to 255; an integer in NR1 format																																				
n/a	*IDN? (see page 120)	<p>AGILENT TECHNOLOGIES,<model>,<serial number>,X.XX.XX</p> <p><model> ::= the model number of the instrument</p> <p><serial number> ::= the serial number of the instrument</p> <p><X.XX.XX> ::= the software revision of the instrument</p>																																				
n/a	*LRN? (see page 123)	<learn_string> ::= current instrument setup as a block of data in IEEE 488.2 # format																																				
*OPC (see page 124)	*OPC? (see page 124)	ASCII "1" is placed in the output queue when all pending device operations have completed.																																				

Table 40 Common (*) Commands Summary (continued)

Command	Query	Options and Query Returns
n/a	*OPT? (see page 125)	<pre> <return_value> ::= 0,0,<license info> <license info> ::= <All field>, <reserved>, <Factory MSO>, <Upgraded MSO>, <Xilinx FPGA Probe>, <Memory>, <Low Speed Serial>, <Automotive Serial>, <reserved>, <Secure>, <Battery>, <Altera FPGA Probe>, <FlexRay Serial>, <Power Measurements>, <RS-232/UART Serial>, <reserved>, <Segmented Memory>, <Mask Test>, <reserved>, <reserved>, <FlexRay Conformance>, <reserved>, <reserved>, <I2S Serial>, <FlexRay Trigger/Decode>, <reserved>, <reserved>, <MIL-STD 1553 Trigger/Decode>, <reserved> <All field> ::= {0 All} <reserved> ::= 0 <Factory MSO> ::= {0 MSO} <Upgraded MSO> ::= {0 MSO} <Xilinx FPGA Probe> ::= {0 FPG} <Memory> ::= {0 mem2M mem8M} <Low Speed Serial> ::= {0 LSS} <Automotive Serial> ::= {0 AMS} <Secure> ::= {0 SEC} <Battery> ::= {0 BAT} <Altera FPGA Probe> ::= {0 ALT} <FlexRay Serial> ::= {0 FRS} <Power Measurements> ::= {0 PWR} <RS-232/UART Serial> ::= {0 232} <Segmented Memory> ::= {0 SGM} <Mask Test> ::= {0 LMT} <FlexRay Conformance> ::= {0 FRC} <I2S Serial> ::= {0 SND} <FlexRay Trigger/Decode> ::= {0 FLX} <MIL-STD 1553 Trigger/Decode> ::= {0 553} </pre>

Table 40 Common (*) Commands Summary (continued)

Command	Query	Options and Query Returns
*RCL <value> (see page 127)	n/a	<value> ::= {0 1 2 3 4 5 6 7 8 9}
*RST (see page 128)	n/a	See *RST (Reset) (see page 128)
*SAV <value> (see page 131)	n/a	<value> ::= {0 1 2 3 4 5 6 7 8 9}
*SRE <mask> (see page 132)	*SRE? (see page 133)	<p><mask> ::= sum of all bits that are set, 0 to 255; an integer in NR1 format. <mask> ::= following values:</p> <pre> Bit Weight Name Enables ----- 7 128 OPER Operation Status Reg 6 64 ---- (Not used.) 5 32 ESB Event Status Bit 4 16 MAV Message Available 3 8 ---- (Not used.) 2 4 MSG Message 1 2 USR User 0 1 TRG Trigger </pre>
n/a	*STB? (see page 134)	<p><value> ::= 0 to 255; an integer in NR1 format, as shown in the following:</p> <pre> Bit Weight Name "1" Indicates ----- 7 128 OPER Operation status condition occurred. 6 64 RQS/ Instrument is MSS requesting service. 5 32 ESB Enabled event status condition occurred. 4 16 MAV Message available. 3 8 ---- (Not used.) 2 4 MSG Message displayed. 1 2 USR User event condition occurred. 0 1 TRG A trigger occurred. </pre>
*TRG (see page 136)	n/a	n/a
n/a	*TST? (see page 137)	<result> ::= 0 or non-zero value; an integer in NR1 format
*WAI (see page 138)	n/a	n/a

Introduction to Common (*) Commands

The common commands are defined by the IEEE 488.2 standard. They are implemented by all instruments that comply with the IEEE 488.2 standard. They provide some of the basic instrument functions, such as instrument identification and reset, reading the instrument setup, and determining how status is read and cleared.

Common commands can be received and processed by the instrument whether they are sent over the interface as separate program messages or within other program messages. If an instrument subsystem has been selected and a common command is received by the instrument, the instrument remains in the selected subsystem. For example, if the program message `":ACQUIRE:TYPE AVERAGE; *CLS; COUNT 256"` is received by the instrument, the instrument sets the acquire type, then clears the status information and sets the average count.

In contrast, if a root level command or some other subsystem command is within the program message, you must re-enter the original subsystem after the command. For example, the program message `":ACQUIRE:TYPE AVERAGE; :AUTOSCALE; :ACQUIRE:COUNT 256"` sets the acquire type, completes the autoscale, then sets the acquire count. In this example, `:ACQUIRE` must be sent again after the `:AUTOSCALE` command in order to re-enter the `ACQUIRE` subsystem and set the count.

NOTE

Each of the status registers has an enable (mask) register. By setting the bits in the enable register, you can select the status information you want to use.

*CLS (Clear Status)

C (see [page 786](#))

Command Syntax

*CLS

The *CLS common command clears the status data structures, the device-defined error queue, and the Request-for-OPC flag.

NOTE

If the *CLS command immediately follows a program message terminator, the output queue and the MAV (message available) bit are cleared.

- See Also**
- "[Introduction to Common \(*\) Commands](#)" on page 116
 - "[*STB \(Read Status Byte\)](#)" on page 134
 - "[*ESE \(Standard Event Status Enable\)](#)" on page 118
 - "[*ESR \(Standard Event Status Register\)](#)" on page 120
 - "[*SRE \(Service Request Enable\)](#)" on page 132
 - "[:SYSTEM:ERROR](#)" on page 448

*ESE (Standard Event Status Enable)

C (see page 786)

Command Syntax *ESE <mask_argument>

<mask_argument> ::= integer from 0 to 255

The *ESE common command sets the bits in the Standard Event Status Enable Register. The Standard Event Status Enable Register contains a mask value for the bits to be enabled in the Standard Event Status Register. A "1" in the Standard Event Status Enable Register enables the corresponding bit in the Standard Event Status Register. A zero disables the bit.

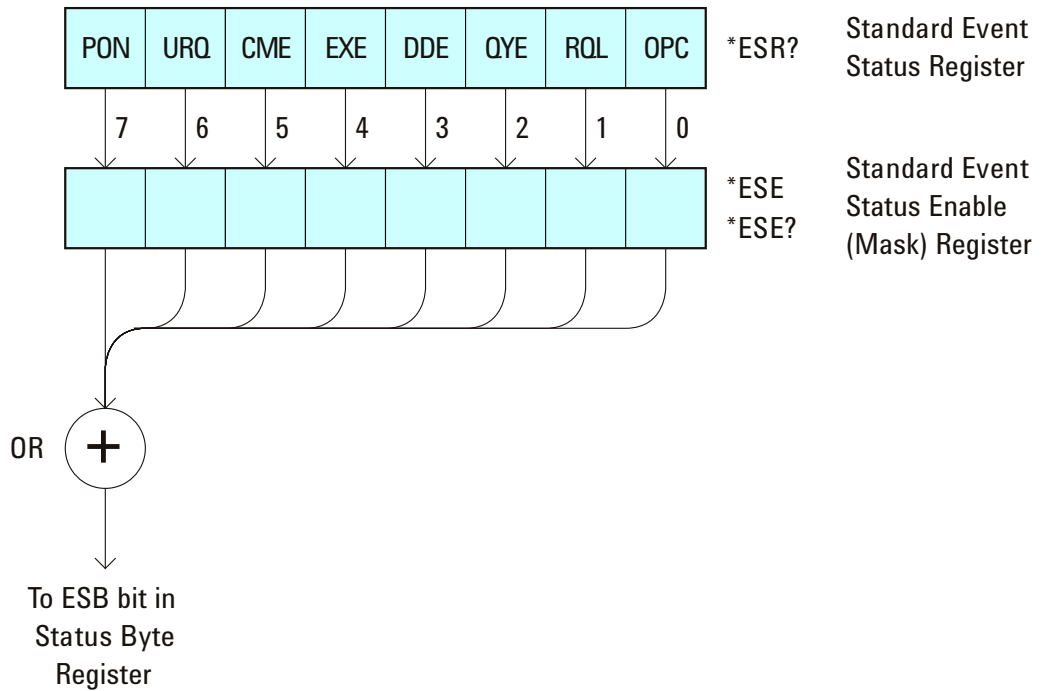

Table 41 Standard Event Status Enable (ESE)

Bit	Name	Description	When Set (1 = High = True), Enables:
7	PON	Power On	Event when an OFF to ON transition occurs.
6	URQ	User Request	Event when a front-panel key is pressed.
5	CME	Command Error	Event when a command error is detected.
4	EXE	Execution Error	Event when an execution error is detected.
3	DDE	Device Dependent Error	Event when a device-dependent error is detected.
2	QYE	Query Error	Event when a query error is detected.

Table 41 Standard Event Status Enable (ESE) (continued)

Bit	Name	Description	When Set (1 = High = True), Enables:
1	RQL	Request Control	Event when the device is requesting control. (Not used.)
0	OPC	Operation Complete	Event when an operation is complete.

Query Syntax *ESE?

The *ESE? query returns the current contents of the Standard Event Status Enable Register.

Return Format <mask_argument><NL>

<mask_argument> ::= 0,...,255; an integer in NR1 format.

- See Also**
- ["Introduction to Common \(*\) Commands"](#) on page 116
 - ["*ESR \(Standard Event Status Register\)"](#) on page 120
 - ["*OPC \(Operation Complete\)"](#) on page 124
 - ["*CLS \(Clear Status\)"](#) on page 117

*ESR (Standard Event Status Register)

C (see page 786)

Query Syntax *ESR?

The *ESR? query returns the contents of the Standard Event Status Register. When you read the Event Status Register, the value returned is the total bit weights of all of the bits that are high at the time you read the byte. Reading the register clears the Event Status Register.

The following table shows bit weight, name, and condition for each bit.

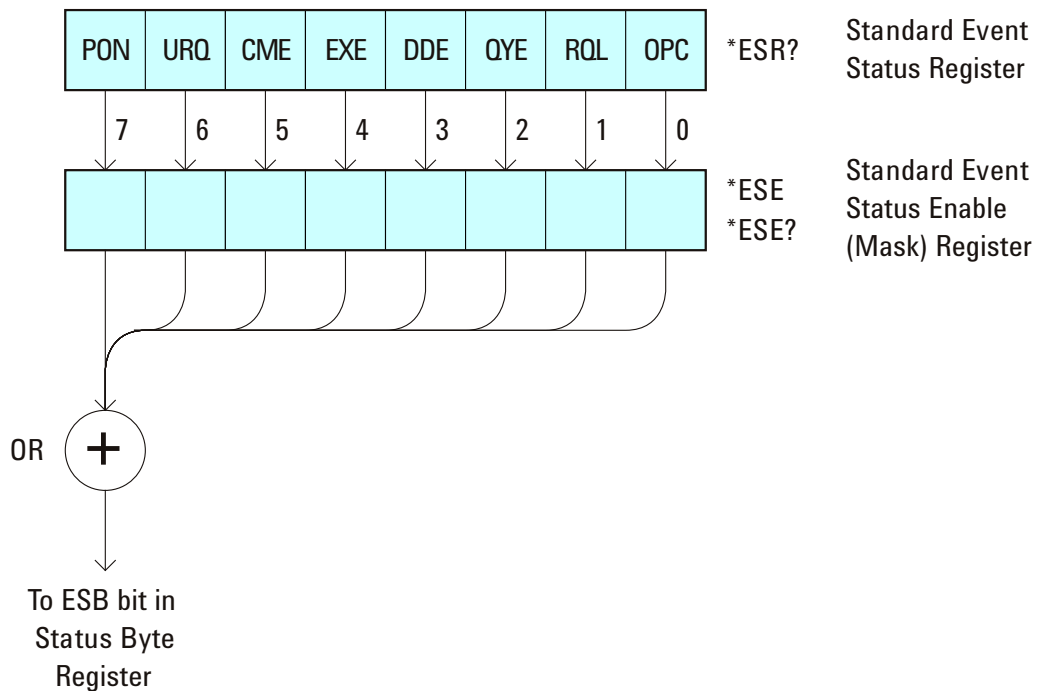

Table 42 Standard Event Status Register (ESR)

Bit	Name	Description	When Set (1 = High = True), Indicates:
7	PON	Power On	An OFF to ON transition has occurred.
6	URQ	User Request	A front-panel key has been pressed.
5	CME	Command Error	A command error has been detected.
4	EXE	Execution Error	An execution error has been detected.
3	DDE	Device Dependent Error	A device-dependent error has been detected.
2	QYE	Query Error	A query error has been detected.

Table 42 Standard Event Status Register (ESR) (continued)

Bit	Name	Description	When Set (1 = High = True), Indicates:
1	RQL	Request Control	The device is requesting control. (Not used.)
0	OPC	Operation Complete	Operation is complete.

Return Format <status><NL>
 <status> ::= 0,..,255; an integer in NR1 format.

NOTE

Reading the Standard Event Status Register clears it. High or 1 indicates the bit is true.

- See Also**
- ["Introduction to Common \(*\) Commands"](#) on page 116
 - ["*ESE \(Standard Event Status Enable\)"](#) on page 118
 - ["*OPC \(Operation Complete\)"](#) on page 124
 - ["*CLS \(Clear Status\)"](#) on page 117
 - [":SYSTem:ERRor"](#) on page 448

*IDN (Identification Number)

C (see [page 786](#))

Query Syntax *IDN?

The *IDN? query identifies the instrument type and software version.

Return Format AGILENT TECHNOLOGIES,<model>,<serial number>,X.XX.XX <NL>

<model> ::= the model number of the instrument

<serial number> ::= the serial number of the instrument

X.XX.XX ::= the software revision of the instrument

- See Also**
- ["Introduction to Common \(*\) Commands"](#) on page 116
 - ["*OPT \(Option Identification\)"](#) on page 125

*LRN (Learn Device Setup)

C (see [page 786](#))

Query Syntax

*LRN?

The *LRN? query result contains the current state of the instrument. This query is similar to the :SYSTEM:SETup? (see [page 452](#)) query, except that it contains ":SYST:SET " before the binary block data. The query result is a valid command that can be used to restore instrument settings at a later time.

Return Format

<learn_string><NL>

<learn_string> ::= :SYST:SET <setup_data>

<setup_data> ::= binary block data in IEEE 488.2 # format

<learn string> specifies the current instrument setup. The block size is subject to change with different firmware revisions.

NOTE

The *LRN? query return format has changed from previous Agilent oscilloscopes to match the IEEE 488.2 specification which says that the query result must contain ":SYST:SET " before the binary block data.

- See Also**
- "[Introduction to Common \(*\) Commands](#)" on page 116
 - "[*RCL \(Recall\)](#)" on page 127
 - "[*SAV \(Save\)](#)" on page 131
 - "[:SYSTEM:SETup](#)" on page 452

*OPC (Operation Complete)

C (see [page 786](#))

Command Syntax *OPC

The *OPC command sets the operation complete bit in the Standard Event Status Register when all pending device operations have finished.

Query Syntax *OPC?

The *OPC? query places an ASCII "1" in the output queue when all pending device operations have completed. The interface hangs until this query returns.

Return Format <complete><NL>

<complete> ::= 1

- See Also**
- ["Introduction to Common \(*\) Commands"](#) on page 116
 - ["*ESE \(Standard Event Status Enable\)"](#) on page 118
 - ["*ESR \(Standard Event Status Register\)"](#) on page 120
 - ["*CLS \(Clear Status\)"](#) on page 117

***OPT (Option Identification)**

C (see [page 786](#))

Query Syntax *OPT?

The *OPT? query reports the options installed in the instrument. This query returns a string that identifies the module and its software revision level.

Return Format 0,0,<license info>

```
<license info> ::= <All field>,<reserved>,<Factory MSO>,<Upgraded MSO>,<Xilinx FPGA Probe>,<Memory>,<Low Speed Serial>,<Automotive Serial>,<reserved>,<Secure>,<Battery>,<Altera FPGA Probe>,<FlexRay Serial>,<Power Measurements>,<RS-232/UART Serial>,<reserved>,<Segmented Memory>,<Mask Test>,<reserved>,<reserved>,<FlexRay Conformance>,<reserved>,<reserved>,<I2S Serial>,<FlexRay Trigger/Decode>,<reserved>,<reserved>,<MIL-STD 1553 Trigger/Decode>,<reserved>
```

```
<All field> ::= {0 | All}
```

```
<reserved> ::= 0
```

```
<Factory MSO> ::= {0 | MSO}
```

```
<Upgraded MSO> ::= {0 | MSO}
```

```
<Xilinx FPGA Probe> ::= {0 | FPG}
```

```
<Memory> ::= {0 | mem2M | mem8M}
```

```
<Low Speed Serial> ::= {0 | LSS}
```

```
<Automotive Serial> ::= {0 | AMS}
```

```
<Secure> ::= {0 | SEC}
```

```
<Battery> ::= {0 | BAT}
```

```
<Altera FPGA Probe> ::= {0 | ALT}
```

```
<FlexRay Serial> ::= {0 | FRS}
```

```
<Power Measurements> ::= {0 | PWR}
```

```
<RS-232/UART Serial> ::= {0 | 232}
```

```
<Segmented Memory> ::= {0 | SGM}
```

```
<Mask Test> ::= {0 | LMT}
```

```
<FlexRay Conformance> ::= {0 | FRC}
```

```
<I2S Serial> ::= {0 | SND}
```

```
<FlexRay Trigger/Decode> ::= {0 | FLX}
```

```
<MIL-STD 1553 Trigger/Decode> ::= {0 | 553}
```

*RCL (Recall)

C (see [page 786](#))

Command Syntax *RCL <value>

<value> ::= {0 | 1 | 2 | 3 | 4 | 5 | 6 | 7 | 8 | 9}

The *RCL command restores the state of the instrument from the specified save/recall register.

- See Also**
- ["Introduction to Common \(*\) Commands"](#) on page 116
 - ["*SAV \(Save\)"](#) on page 131

***RST (Reset)**

C (see page 786)

Command Syntax *RST

The *RST command places the instrument in a known state. Reset conditions are:

Acquire Menu	
Mode	Normal
Realtime	On
Averaging	Off
# Averages	8

Analog Channel Menu	
Channel 1	On
Channel 2	Off
Volts/division	5.00 V
Offset	0.00
Coupling	DC
Probe attenuation	AutoProbe (if AutoProbe is connected), otherwise 1.0:1
Vernier	Off
Invert	Off
BW limit	Off
Impedance	1 M Ohm
Units	Volts
Skew	0

Cursor Menu	
Source	Channel 1

Digital Channel Menu (MSO models only)	
Channel 0 - 15	Off
Labels	Off
Threshold	TTL (1.4V)

Display Menu	
Definite persistence	Off
Grid	33%
Vectors	On

Quick Meas Menu	
Source	Channel 1

Run Control	
	Scope is running

Time Base Menu	
Main time/division	100 us
Main time base delay	0.00 s
Delay time/division	500 ns
Delay time base delay	0.00 s
Reference	center
Mode	main
Vernier	Off

Trigger Menu	
Type	Edge
Mode	Auto
Coupling	dc
Source	Channel 1
Level	0.0 V

Trigger Menu	
Slope	Positive
HF Reject and noise reject	Off
Holdoff	60 ns
External probe attenuation	AutoProbe (if AutoProbe is connected), otherwise 1.0:1
External Units	Volts
External Impedance	1 M Ohm

See Also • ["Introduction to Common \(*\) Commands"](#) on page 116

Example Code

```
' RESET - This command puts the oscilloscope into a known state.
' This statement is very important for programs to work as expected.
' Most of the following initialization commands are initialized by
' *RST. It is not necessary to reinitialize them unless the default
' setting is not suitable for your application.
myScope.WriteString "*RST" ' Reset the oscilloscope to the defaults.
```

Example program from the start: ["VISA COM Example in Visual Basic"](#) on page 812

*SAV (Save)

C (see [page 786](#))

Command Syntax *SAV <value>

<value> ::= {0 | 1 | 2 | 3 | 4 | 5 | 6 | 7 | 8 | 9}

The *SAV command stores the current state of the instrument in a save register. The data parameter specifies the register where the data will be saved.

- See Also**
- ["Introduction to Common \(*\) Commands"](#) on page 116
 - ["*RCL \(Recall\)"](#) on page 127

***SRE (Service Request Enable)**

C (see page 786)

Command Syntax *SRE <mask>

<mask> ::= integer with values defined in the following table.

The *SRE command sets the bits in the Service Request Enable Register. The Service Request Enable Register contains a mask value for the bits to be enabled in the Status Byte Register. A one in the Service Request Enable Register enables the corresponding bit in the Status Byte Register. A zero disables the bit.

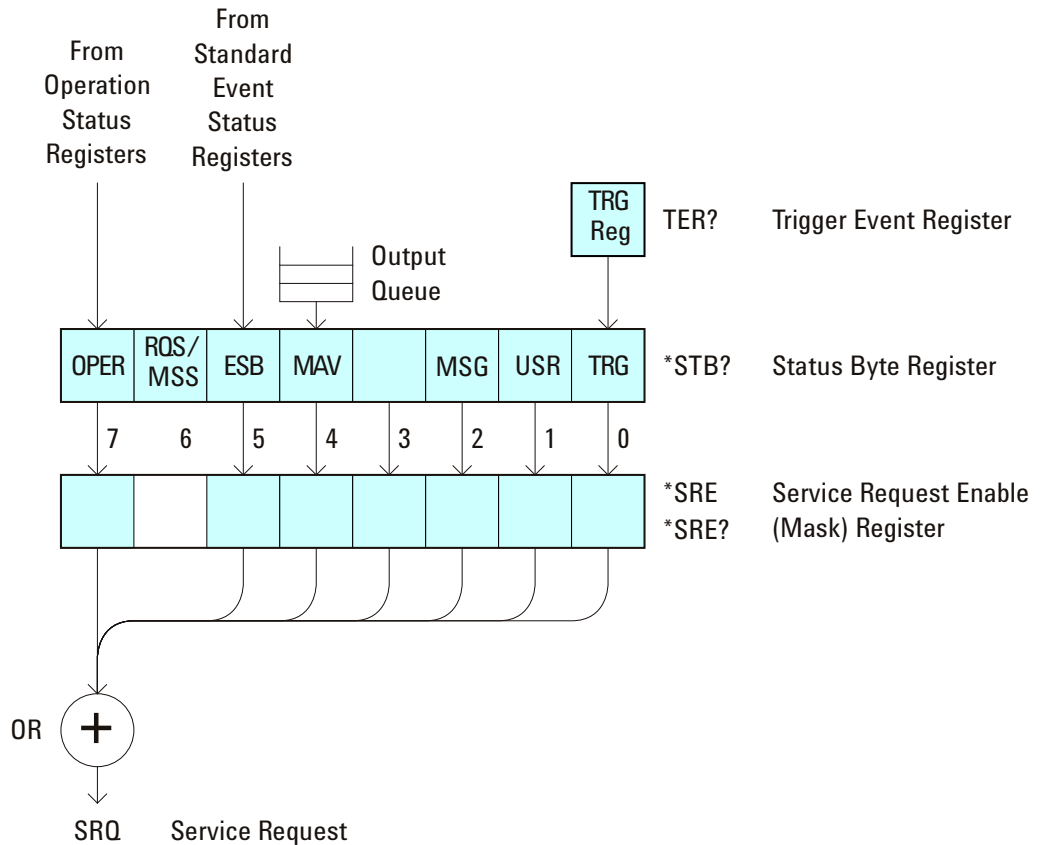

Table 43 Service Request Enable Register (SRE)

Bit	Name	Description	When Set (1 = High = True), Enables:
7	OPER	Operation Status Register	Interrupts when enabled conditions in the Operation Status Register (OPER) occur.
6	---	---	(Not used.)

Table 43 Service Request Enable Register (SRE) (continued)

Bit	Name	Description	When Set (1 = High = True), Enables:
5	ESB	Event Status Bit	Interrupts when enabled conditions in the Standard Event Status Register (ESR) occur.
4	MAV	Message Available	Interrupts when messages are in the Output Queue.
3	---	---	(Not used.)
2	MSG	Message	Interrupts when an advisory has been displayed on the oscilloscope.
1	USR	User Event	Interrupts when enabled user event conditions occur.
0	TRG	Trigger	Interrupts when a trigger occurs.

Query Syntax *SRE?

The *SRE? query returns the current value of the Service Request Enable Register.

Return Format <mask><NL>

<mask> ::= sum of all bits that are set, 0,...,255;
an integer in NR1 format

- See Also**
- ["Introduction to Common \(*\) Commands"](#) on page 116
 - ["*STB \(Read Status Byte\)"](#) on page 134
 - ["*CLS \(Clear Status\)"](#) on page 117

***STB (Read Status Byte)**

C (see page 786)

Query Syntax *STB?

The *STB? query returns the current value of the instrument's status byte. The MSS (Master Summary Status) bit is reported on bit 6 instead of the RQS (request service) bit. The MSS indicates whether or not the device has at least one reason for requesting service.

Return Format <value><NL>
 <value> ::= 0,...,255; an integer in NR1 format

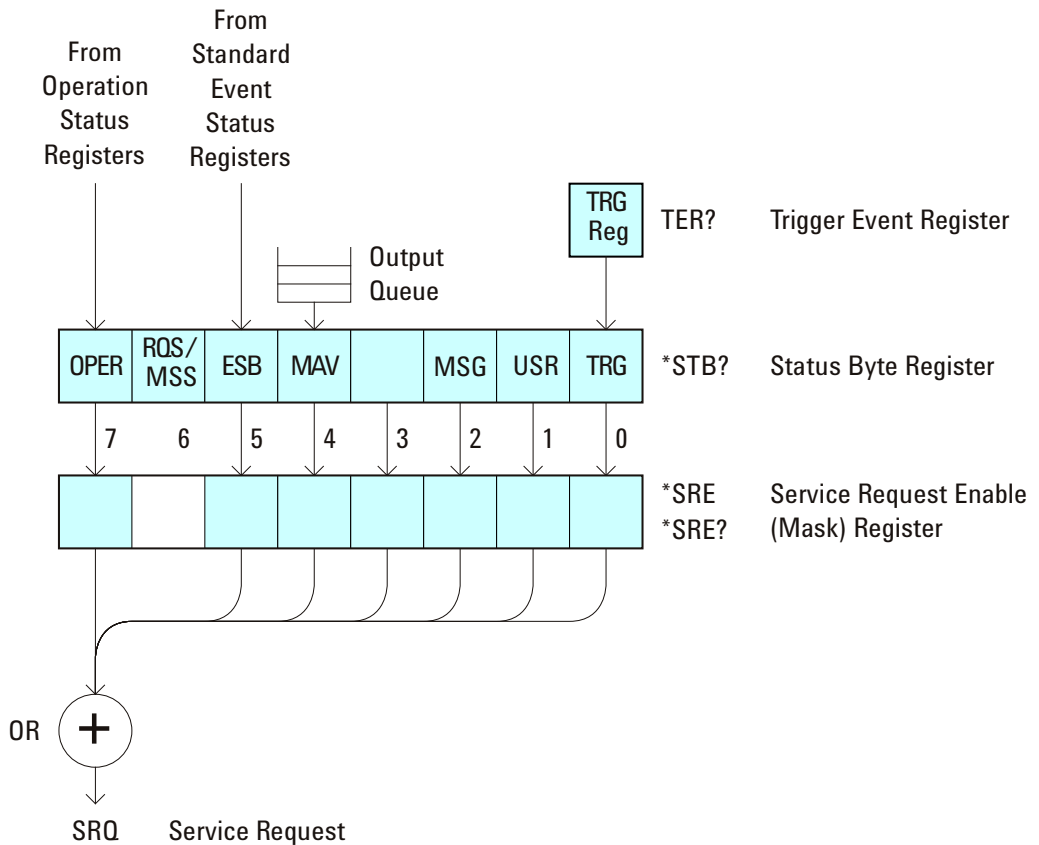

Table 44 Status Byte Register (STB)

Bit	Name	Description	When Set (1 = High = True), Indicates:
7	OPER	Operation Status Register	An enabled condition in the Operation Status Register (OPER) has occurred.

Table 44 Status Byte Register (STB) (continued)

Bit	Name	Description	When Set (1 = High = True), Indicates:
6	RQS	Request Service	When polled, that the device is requesting service.
	MSS	Master Summary Status	When read (by *STB?), whether the device has a reason for requesting service.
5	ESB	Event Status Bit	An enabled condition in the Standard Event Status Register (ESR) has occurred.
4	MAV	Message Available	There are messages in the Output Queue.
3	---	---	(Not used, always 0.)
2	MSG	Message	An advisory has been displayed on the oscilloscope.
1	USR	User Event	An enabled user event condition has occurred.
0	TRG	Trigger	A trigger has occurred.

NOTE

To read the instrument's status byte with RQS reported on bit 6, use the interface Serial Poll.

- See Also**
- ["Introduction to Common \(*\) Commands"](#) on page 116
 - ["*SRE \(Service Request Enable\)"](#) on page 132

*TRG (Trigger)

C (see [page 786](#))

Command Syntax *TRG

The *TRG command has the same effect as the :DIGitize command with no parameters.

- See Also**
- ["Introduction to Common \(*\) Commands"](#) on page 116
 - [":DIGitize"](#) on page 150
 - [":RUN"](#) on page 174
 - [":STOP"](#) on page 178

*TST (Self Test)

C (see [page 786](#))

Query Syntax *TST?

The *TST? query performs a self-test on the instrument. The result of the test is placed in the output queue. A zero indicates the test passed and a non-zero indicates the test failed. If the test fails, refer to the troubleshooting section of the *Service Guide*.

Return Format <result><NL>

<result> ::= 0 or non-zero value; an integer in NR1 format

See Also • ["Introduction to Common \(*\) Commands"](#) on page 116

*WAI (Wait To Continue)

C (see [page 786](#))

Command Syntax *WAI

The *WAI command has no function in the oscilloscope, but is parsed for compatibility with other instruments.

See Also • ["Introduction to Common \(*\) Commands"](#) on page 116

Root (:) Commands

Control many of the basic functions of the oscilloscope and reside at the root level of the command tree. See "Introduction to Root (:) Commands" on page 141.

Table 45 Root (:) Commands Summary

Command	Query	Options and Query Returns
:ACTivity (see page 142)	:ACTivity? (see page 142)	<return value> ::= <edges>,<levels> <edges> ::= presence of edges (32-bit integer in NR1 format) <levels> ::= logical highs or lows (32-bit integer in NR1 format)
n/a	:AER? (see page 143)	{0 1}; an integer in NR1 format
:AUToscale [<source>[,...,<source>]] (see page 144)	n/a	<source> ::= CHANnel<n> for DSO models <source> ::= {CHANnel<n> DIGital0,...,DIGital15 POD1 POD2} for MSO models <source> can be repeated up to 5 times <n> ::= 1-2 or 1-4 in NR1 format
:AUToscale:AMODE <value> (see page 146)	:AUToscale:AMODE? (see page 146)	<value> ::= {NORMAL CURRENT}}
:AUToscale:CHANnels <value> (see page 147)	:AUToscale:CHANnels? (see page 147)	<value> ::= {ALL DISPLAYed}}
:BLANK [<source>] (see page 148)	n/a	<source> ::= {CHANnel<n>} FUNCTION MATH SBUS} for DSO models <source> ::= {CHANnel<n> DIGital0,...,DIGital15 POD{1 2} BUS{1 2} FUNCTION MATH SBUS} for MSO models <n> ::= 1-2 or 1-4 in NR1 format
:CDISplay (see page 149)	n/a	n/a

5 Commands by Subsystem

Table 45 Root (:): Commands Summary (continued)

Command	Query	Options and Query Returns
:DIGitize [<source>[,...,<source>]] (see page 150)	n/a	<source> ::= {CHANnel<n> FUNCTION MATH SBUS} for DSO models <source> ::= {CHANnel<n> DIGital0,...,DIGital15 POD{1 2} BUS{1 2} FUNCTION MATH SBUS} for MSO models <source> can be repeated up to 5 times <n> ::= 1-2 or 1-4 in NR1 format
:HWEenable <n> (see page 152)	:HWEenable? (see page 152)	<n> ::= 16-bit integer in NR1 format
n/a	:HWERegister:CONDition? (see page 154)	<n> ::= 16-bit integer in NR1 format
n/a	:HWERegister[:EVENT]? (see page 156)	<n> ::= 16-bit integer in NR1 format
:MERGE <pixel memory> (see page 158)	n/a	<pixel memory> ::= {PMEMory{0 1 2 3 4 5 6 7 8 9}}
:MTEenable <n> (see page 159)	:MTEenable? (see page 159)	<n> ::= 16-bit integer in NR1 format
n/a	:MTERegister[:EVENT]? (see page 161)	<n> ::= 16-bit integer in NR1 format
:OPEE <n> (see page 163)	:OPEE? (see page 164)	<n> ::= 16-bit integer in NR1 format
n/a	:OPERRegister:CONDition? (see page 165)	<n> ::= 16-bit integer in NR1 format
n/a	:OPERRegister[:EVENT]? (see page 167)	<n> ::= 16-bit integer in NR1 format
:OVLenable <mask> (see page 169)	:OVLenable? (see page 170)	<mask> ::= 16-bit integer in NR1 format as shown: Bit Weight Input ----- 10 1024 Ext Trigger Fault 9 512 Channel 4 Fault 8 256 Channel 3 Fault 7 128 Channel 2 Fault 6 64 Channel 1 Fault 4 16 Ext Trigger OVL 3 8 Channel 4 OVL 2 4 Channel 3 OVL 1 2 Channel 2 OVL 0 1 Channel 1 OVL

Table 45 Root (:) Commands Summary (continued)

Command	Query	Options and Query Returns
n/a	:OVLRegister? (see page 171)	<value> ::= integer in NR1 format. See OVLenable for <value>
:PRINT [<options>] (see page 173)	n/a	<options> ::= [<print option>][,...,<print option>] <print option> ::= {COLor GRAYscale PRINter0 BMP8bit BMP PNG NOFactoRs FACToRs} <print option> can be repeated up to 5 times.
:RUN (see page 174)	n/a	n/a
n/a	:SERial (see page 175)	<return value> ::= unquoted string containing serial number
:SINGle (see page 176)	n/a	n/a
n/a	:STATus? <display> (see page 177)	{0 1} <display> ::= {CHANnel<n> DIGital0,...,DIGital15 POD{1 2} BUS{1 2} FUNctioN MATH SBUS} <n> ::= 1-2 or 1-4 in NR1 format
:STOP (see page 178)	n/a	n/a
n/a	:TER? (see page 179)	{0 1}
:VIEW <source> (see page 180)	n/a	<source> ::= {CHANnel<n> PMEMory{0 1 2 3 4 5 6 7 8 9} FUNctioN MATH SBUS} for DSO models <source> ::= {CHANnel<n> DIGital0,...,DIGital15 PMEMory{0 1 2 3 4 5 6 7 8 9} POD{1 2} BUS{1 2} FUNctioN MATH SBUS} for MSO models <n> ::= 1-2 or 1-4 in NR1 format

Introduction to Root (:) Commands

Root level commands control many of the basic operations of the instrument. These commands are always recognized by the parser if they are prefixed with a colon, regardless of current command tree position. After executing a root-level command, the parser is positioned at the root of the command tree.

:ACTivity

N (see [page 786](#))

Command Syntax :ACTivity

The :ACTivity command clears the cumulative edge variables for the next activity query.

Query Syntax :ACTivity?

The :ACTivity? query returns whether there has been activity (edges) on the digital channels since the last query, and returns the current logic levels.

NOTE

Because the :ACTivity? query returns edge activity since the last :ACTivity? query, you must send this query twice before the edge activity result is valid.

Return Format

<edges>,<levels><NL>

<edges> ::= presence of edges (16-bit integer in NR1 format).

<levels> ::= logical highs or lows (16-bit integer in NR1 format).

bit 0 ::= DIGital 0

bit 15 ::= DIGital 15

NOTE

A bit = 0 (zero) in the <edges> result indicates that no edges were detected on that channel (across the specified threshold voltage) since the last query.

A bit = 1 (one) in the <edges> result indicates that edges have been detected on that channel (across the specified threshold voltage) since the last query.

(The threshold voltage must be set appropriately for the logic levels of the signals being probed.)

- See Also**
- ["Introduction to Root \(: \) Commands"](#) on page 141
 - [":POD<n>:THReshold"](#) on page 395
 - [":DIGital<n>:THReshold"](#) on page 243

:AER (Arm Event Register)

C (see [page 786](#))

Query Syntax :AER?

The AER query reads the Arm Event Register. After the Arm Event Register is read, it is cleared. A "1" indicates the trigger system is in the armed state, ready to accept a trigger.

The Armed Event Register is summarized in the Wait Trig bit of the Operation Status Event Register. A Service Request can be generated when the Wait Trig bit transitions and the appropriate enable bits have been set in the Operation Status Enable Register (OPEE) and the Service Request Enable Register (SRE).

Return Format <value><NL>

<value> ::= {0 | 1}; an integer in NR1 format.

- See Also**
- ["Introduction to Root \(: \) Commands"](#) on page 141
 - [":OPEE \(Operation Status Enable Register\)"](#) on page 163
 - [":OPERRegister:CONDition \(Operation Status Condition Register\)"](#) on page 165
 - [":OPERRegister\[:EVENT\] \(Operation Status Event Register\)"](#) on page 167
 - ["*STB \(Read Status Byte\)"](#) on page 134
 - ["*SRE \(Service Request Enable\)"](#) on page 132

:AUToscale

C (see [page 786](#))

Command Syntax

```
:AUToscale
```

```
:AUToscale [<source>[,...,<source>]]
```

```
<source> ::= CHANnel<n> for the DSO models
```

```
<source> ::= {DIGital0,...,DIGital15 | POD1 | POD2 | CHANnel<n>} for the  
MSO models
```

```
<n> ::= {1 | 2 | 3 | 4} for the four channel oscilloscope models
```

```
<n> ::= {1 | 2} for the two channel oscilloscope models
```

The <source> parameter may be repeated up to 5 times.

The :AUToscale command evaluates all input signals and sets the correct conditions to display the signals. This is the same as pressing the Autoscale key on the front panel.

If one or more sources are specified, those specified sources will be enabled and all others blanked. The autoscale channels mode (see [":AUToscale:CHANnels"](#) on page 147) is set to DISplayed channels. Then, the autoscale is performed.

When the :AUToscale command is sent, the following conditions are affected and actions are taken:

- Thresholds.
- Channels with activity around the trigger point are turned on, others are turned off.
- Channels are reordered on screen; analog channel 1 first, followed by the remaining analog channels, then the digital channels 0-15.
- Delay is set to 0 seconds.
- Time/Div.

The :AUToscale command does not affect the following conditions:

- Label names.
- Trigger conditioning.

The :AUToscale command turns off the following items:

- Cursors.
- Measurements.
- Trace memories.
- Zoomed (delayed) time base mode.

For further information on :AUToscale, see the *User's Guide*.

- See Also**
- ["Introduction to Root \(: \) Commands"](#) on page 141
 - [":AUToscale:CHANnels"](#) on page 147
 - [":AUToscale:AMODE"](#) on page 146

Example Code

```
' AUTOSCALE - This command evaluates all the input signals and sets  
' the correct conditions to display all of the active signals.  
myScope.WriteString ":AUTOSCALE" ' Same as pressing Autoscale key.
```

Example program from the start: ["VISA COM Example in Visual Basic"](#) on page 812

:AUToscale:AMODE

N (see [page 786](#))

Command Syntax :AUToscale:AMODE <value>
<value> ::= {NORMal | CURRent}

The :AUToscale:AMODE command specifies the acquisition mode that is set by subsequent :AUToscales.

- When NORMal is selected, an :AUToscale command sets the NORMal acquisition type and the RTIME (real-time) acquisition mode.
- When CURRent is selected, the current acquisition type and mode are kept on subsequent :AUToscales.

Use the :ACQUIRE:TYPE and :ACQUIRE:MODE commands to set the acquisition type and mode.

Query Syntax :AUToscale:AMODE?

The :AUToscale:AMODE? query returns the autoscale acquire mode setting.

Return Format <value><NL>
<value> ::= {NORM | CURR}

- See Also**
- ["Introduction to Root \(: \) Commands"](#) on page 141
 - [":AUToscale"](#) on page 144
 - [":AUToscale:CHANnels"](#) on page 147
 - [":ACQUIRE:TYPE"](#) on page 196
 - [":ACQUIRE:MODE"](#) on page 187

:AUToscale:CHANnels

N (see [page 786](#))

Command Syntax :AUToscale:CHANnels <value>
 <value> ::= {ALL | DISplayed}

The :AUToscale:CHANnels command specifies which channels will be displayed on subsequent :AUToscales.

- When ALL is selected, all channels that meet the requirements of :AUToscale will be displayed.
- When DISplayed is selected, only the channels that are turned on are autoscaled.

Use the :VIEW or :BLANK root commands to turn channels on or off.

Query Syntax :AUToscale:CHANnels?

The :AUToscale:CHANnels? query returns the autoscale channels setting.

Return Format <value><NL>
 <value> ::= {ALL | DISP}

- See Also**
- "[Introduction to Root \(: \) Commands](#)" on page 141
 - "[:AUToscale](#)" on page 144
 - "[:AUToscale:AMODE](#)" on page 146
 - "[:VIEW](#)" on page 180
 - "[:BLANK](#)" on page 148

:BLANK

N (see [page 786](#))

Command Syntax :BLANK [<source>]

<source> ::= {CHANnel<n> | FUNCTION | MATH | SBUS} for the DSO models

<source> ::= {CHANnel<n> | DIGital0,...,DIGital15 | POD{1 | 2}
| BUS{1 | 2} | FUNCTION | MATH | SBUS} for the MSO models

<n> ::= {1 | 2 | 3 | 4} for the four channel oscilloscope models

<n> ::= {1 | 2} for the two channel oscilloscope models

The :BLANK command turns off (stops displaying) the specified channel, digital pod, math function, or serial decode bus. The :BLANK command with no parameter turns off all sources.

NOTE

To turn on (start displaying) a channel, etc., use the :VIEW command. The DISPLAY commands, :CHANnel<n>:DISPLAY, :FUNCTION:DISPLAY, :POD<n>:DISPLAY, or :DIGital<n>:DISPLAY, are the preferred method to turn on/off a channel, etc.

NOTE

MATH is an alias for FUNCTION.

- See Also**
- ["Introduction to Root \(: \) Commands"](#) on page 141
 - [":CDISplay"](#) on page 149
 - [":CHANnel<n>:DISPlay"](#) on page 222
 - [":DIGital<n>:DISPlay"](#) on page 239
 - [":FUNCTION:DISPlay"](#) on page 268
 - [":POD<n>:DISPlay"](#) on page 393
 - [":STATus"](#) on page 177
 - [":VIEW"](#) on page 180

- Example Code**
- ["Example Code"](#) on page 180

:CDISplay

C (see [page 786](#))

Command Syntax :CDISplay

The :CDISplay command clears the display and resets all associated measurements. If the oscilloscope is stopped, all currently displayed data is erased. If the oscilloscope is running, all the data in active channels and functions is erased; however, new data is displayed on the next acquisition.

- See Also**
- "[Introduction to Root \(:\)](#) Commands" on page 141
 - "[:DISPlay:CLEar](#)" on page 246

:DIGitize

C (see [page 786](#))

Command Syntax :DIGitize [<source>[,...,<source>]]

<source> ::= {CHANnel<n> | FUNction | MATH | SBUS} for the DSO models

<source> ::= {CHANnel<n> | DIGital0,...,DIGital15 | POD{1 | 2} | BUS{1 | 2} | FUNction | MATH | SBUS} for the MSO models

<n> ::= {1 | 2 | 3 | 4} for the four channel oscilloscope models

<n> ::= {1 | 2} for the two channel oscilloscope models

The <source> parameter may be repeated up to 5 times.

The :DIGitize command is a specialized RUN command. It causes the instrument to acquire waveforms according to the settings of the :ACQUIRE commands subsystem. When the acquisition is complete, the instrument is stopped. If no argument is given, :DIGitize acquires the channels currently displayed. If no channels are displayed, all channels are acquired.

NOTE

To halt a :DIGitize in progress, use the device clear command.

NOTE

MATH is an alias for FUNction.

- See Also**
- "[Introduction to Root \(: \) Commands](#)" on page 141
 - "[:RUN](#)" on page 174
 - "[:SINGLE](#)" on page 176
 - "[:STOP](#)" on page 178
 - "[:ACQUIRE Commands](#)" on page 181
 - "[:WAVEFORM Commands](#)" on page 616

Example Code

```
' DIGITIZE - Used to acquire the waveform data for transfer over
' the interface. Sending this command causes an acquisition to
' take place with the resulting data being placed in the buffer.
'
' NOTE! The DIGITIZE command is highly recommended for triggering
' modes other than SINGLE. This ensures that sufficient data is
' available for measurement. If DIGITIZE is used with single mode,
' the completion criteria may never be met. The number of points
' gathered in Single mode is related to the sweep speed, memory
' depth, and maximum sample rate. For example, take an oscilloscope
' with a 1000-point memory, a sweep speed of 10 us/div (100 us
' total time across the screen), and a 20 MSa/s maximum sample rate.
' 1000 divided by 100 us equals 10 MSa/s. Because this number is
```

```
' less than or equal to the maximum sample rate, the full 1000 points
' will be digitized in a single acquisition. Now, use 1 us/div
' (10 us across the screen). 1000 divided by 10 us equals 100 MSa/s;
' because this is greater than the maximum sample rate by 5 times,
' only 400 points (or 1/5 the points) can be gathered on a single
' trigger. Keep in mind when the oscilloscope is running,
' communication with the computer interrupts data acquisition.
' Setting up the oscilloscope over the bus causes the data buffers
' to be cleared and internal hardware to be reconfigured. If a
' measurement is immediately requested, there may have not been
' enough time for the data acquisition process to collect data, and
' the results may not be accurate. An error value of 9.9E+37 may be
' returned over the bus in this situation.
'
```

myScope.WriteString ":DIGITIZE CHAN1"

Example program from the start: ["VISA COM Example in Visual Basic"](#) on page 812

:HWEenable (Hardware Event Enable Register)

N (see page 786)

Command Syntax :HWEenable <mask>
 <mask> ::= 16-bit integer

The :HWEenable command sets a mask in the Hardware Event Enable register. Set any of the following bits to "1" to enable bit 12 in the Operation Status Condition Register and potentially cause an SRQ (Service Request interrupt) to be generated.

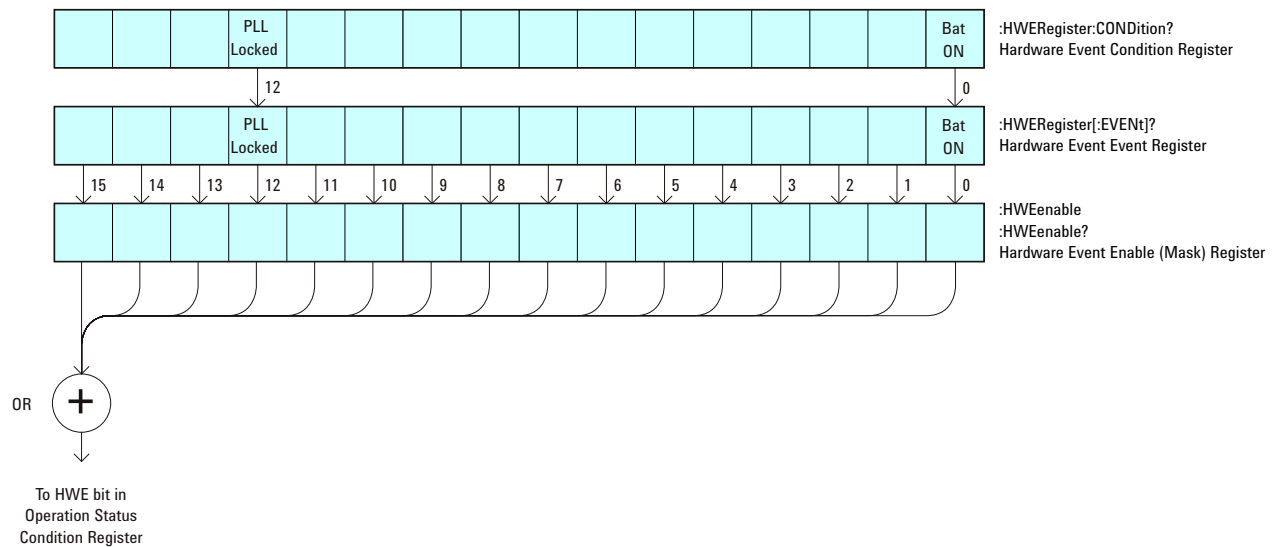

Table 46 Hardware Event Enable Register (HWEenable)

Bit	Name	Description	When Set (1 = High = True), Enables:
15-13	---	---	(Not used.)
12	PLL Locked	PLL Locked	This bit is for internal use and is not intended for general use.
11-1	---	---	(Not used.)
0	Bat On	Battery On	Event when the battery is on.

Query Syntax :HWEenable?

The :HWEenable? query returns the current value contained in the Hardware Event Enable register as an integer number.

Return Format <value><NL>
 <value> ::= integer in NR1 format.

- See Also**
- "Introduction to Root (:) Commands" on page 141
 - ":AER (Arm Event Register)" on page 143
 - ":CHANnel<n>:PROTection" on page 232
 - ":EXTErnal:PROTection" on page 261
 - ":OPERegister[:EVENT] (Operation Status Event Register)" on page 167
 - ":OVLenable (Overload Event Enable Register)" on page 169
 - ":OVLRegister (Overload Event Register)" on page 171
 - "**STB (Read Status Byte)" on page 134
 - "**SRE (Service Request Enable)" on page 132

:HWERegister:CONDition (Hardware Event Condition Register)

N (see page 786)

Query Syntax :HWERegister:CONDition?

The :HWERegister:CONDition? query returns the integer value contained in the Hardware Event Condition Register.

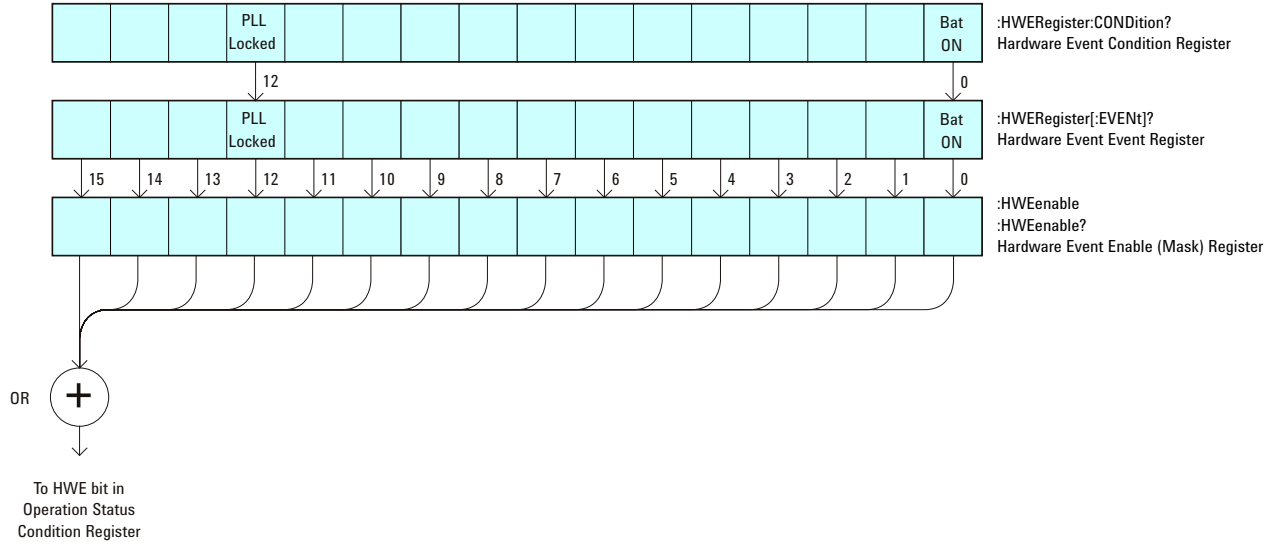

Table 47 Hardware Event Condition Register

Bit	Name	Description	When Set (1 = High = True), Indicates:
15-13	---	---	(Not used.)
12	PLL Locked	PLL Locked	This bit is for internal use and is not intended for general use.
11-1	---	---	(Not used.)
0	Bat On	Battery On	The battery is on.

Return Format <value><NL>

<value> ::= integer in NR1 format.

- See Also**
- "Introduction to Root (:) Commands" on page 141
 - ":CHANnel<n>:PROTection" on page 232
 - ":EXTeRnal:PROTection" on page 261
 - ":OPEE (Operation Status Enable Register)" on page 163
 - ":OPERegister[:EVENT] (Operation Status Event Register)" on page 167

- ":OVLenable (Overload Event Enable Register)" on page 169
- ":OVLRegister (Overload Event Register)" on page 171
- "*STB (Read Status Byte)" on page 134
- "*SRE (Service Request Enable)" on page 132

:HWERegister[:EVENT] (Hardware Event Event Register)

N (see page 786)

Query Syntax :HWERegister[:EVENT]?

The :HWERegister[:EVENT]? query returns the integer value contained in the Hardware Event Event Register.

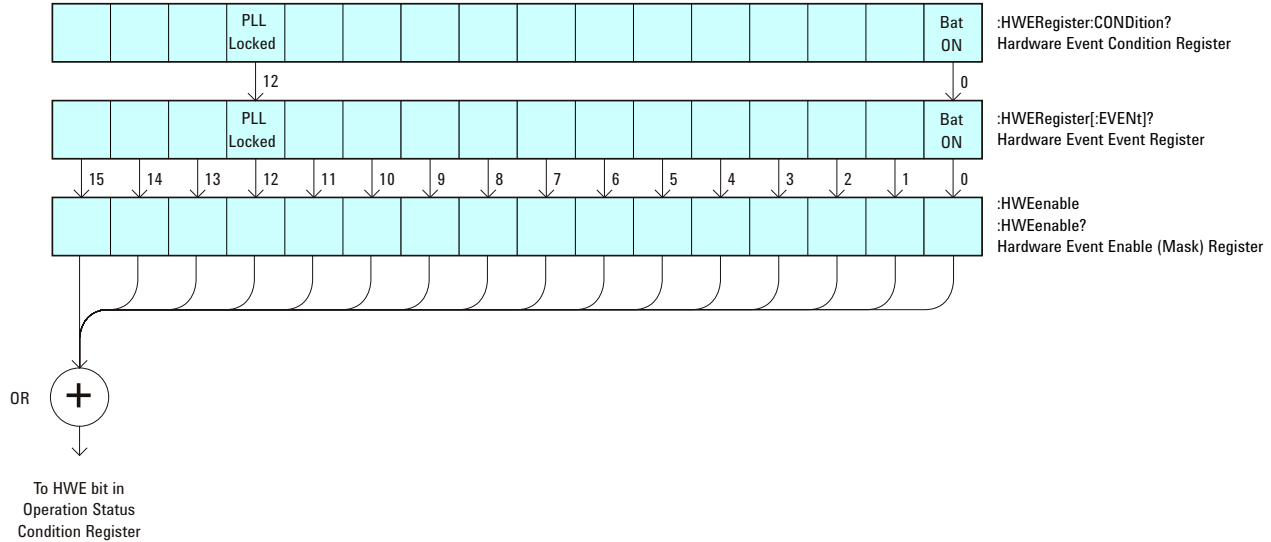

Table 48 Hardware Event Event Register

Bit	Name	Description	When Set (1 = High = True), Indicates:
15-13	---	---	(Not used.)
12	PLL Locked	PLL Locked	This bit is for internal use and is not intended for general use.
11-1	---	---	(Not used.)
0	Bat On	Battery On	The battery is on.

Return Format <value><NL>

<value> ::= integer in NR1 format.

- See Also**
- "Introduction to Root (:) Commands" on page 141
 - ":CHANnel<n>:PROTection" on page 232
 - ":EXTeRnal:PROTection" on page 261
 - ":OPEE (Operation Status Enable Register)" on page 163

- ":OPERRegister:CONDition (Operation Status Condition Register)" on page 165
- ":OVLenable (Overload Event Enable Register)" on page 169
- ":OVLRegister (Overload Event Register)" on page 171
- "*STB (Read Status Byte)" on page 134
- "*SRE (Service Request Enable)" on page 132

:MERGe

N (see [page 786](#))

Command Syntax :MERGe <pixel memory>

```
<pixel memory> ::= {PMEMemory0 | PMEMemory1 | PMEMemory2 | PMEMemory3  
                   | PMEMemory4 | PMEMemory5 | PMEMemory6 | PMEMemory7  
                   | PMEMemory8 | PMEMemory9}
```

The :MERGe command stores the contents of the active display in the specified pixel memory. The previous contents of the pixel memory are overwritten. The pixel memories are PMEMemory0 through PMEMemory9. This command is similar to the function of the "Save To: INTERN_<n>" key in the Save/Recall menu.

- See Also**
- ["Introduction to Root \(: \) Commands"](#) on page 141
 - ["*SAV \(Save\)"](#) on page 131
 - ["*RCL \(Recall\)"](#) on page 127
 - [":VIEW"](#) on page 180
 - [":BLANK"](#) on page 148

:MTEenable (Mask Test Event Enable Register)

N (see page 786)

Command Syntax :MTEenable <mask>
 <mask> ::= 16-bit integer

The :MTEenable command sets a mask in the Mask Test Event Enable register. Set any of the following bits to "1" to enable bit 9 in the Operation Status Condition Register and potentially cause an SRQ (Service Request interrupt) to be generated.

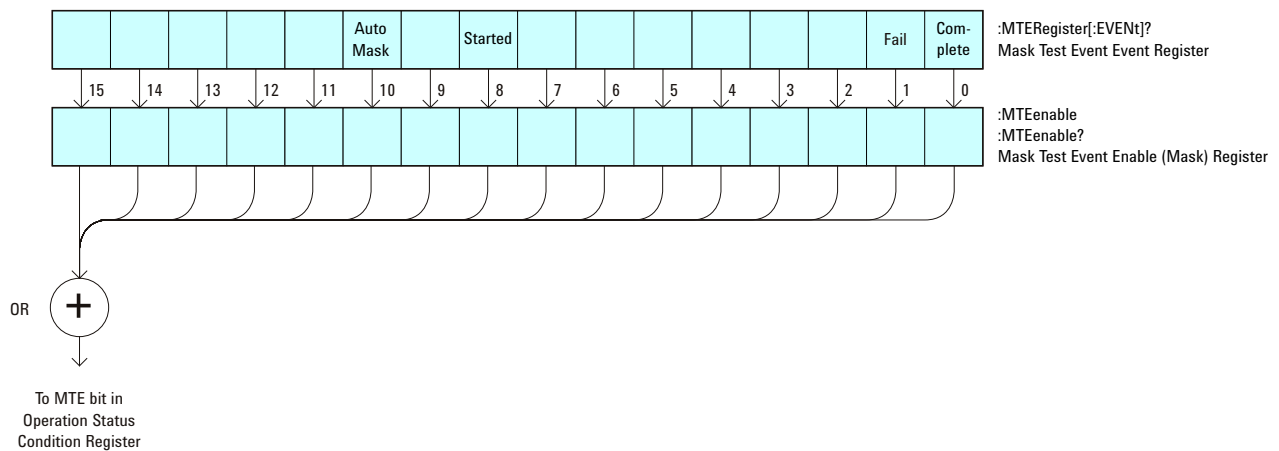

Table 49 Mask Test Event Enable Register (MTEenable)

Bit	Name	Description	When Set (1 = High = True), Enables:
15-11	---	---	(Not used.)
10	Auto Mask	Auto Mask Created	Auto mask creation completed.
9	---	---	(Not used.)
8	Started	Mask Testing Started	Mask testing started.
7-2	---	---	(Not used.)
1	Fail	Mask Test Fail	Mask test failed.
0	Complete	Mask Test Complete	Mask test is complete.

Query Syntax :MTEenable?

The :MTEenable? query returns the current value contained in the Mask Test Event Enable register as an integer number.

5 Commands by Subsystem

Return Format <value><NL>

<value> ::= integer in NR1 format.

- See Also**
- ["Introduction to Root \(: \) Commands"](#) on page 141
 - [":AER \(Arm Event Register\)"](#) on page 143
 - [":CHANnel<n>:PROTection"](#) on page 232
 - [":EXTernal:PROTection"](#) on page 261
 - [":OPERegister\[:EVENT\] \(Operation Status Event Register\)"](#) on page 167
 - [":OVLenable \(Overload Event Enable Register\)"](#) on page 169
 - [":OVLRegister \(Overload Event Register\)"](#) on page 171
 - ["*STB \(Read Status Byte\)"](#) on page 134
 - ["*SRE \(Service Request Enable\)"](#) on page 132

:MTERegister[:EVENT] (Mask Test Event Event Register)

N (see page 786)

Query Syntax :MTERegister[:EVENT]?

The :MTERegister[:EVENT]? query returns the integer value contained in the Mask Test Event Event Register and clears the register.

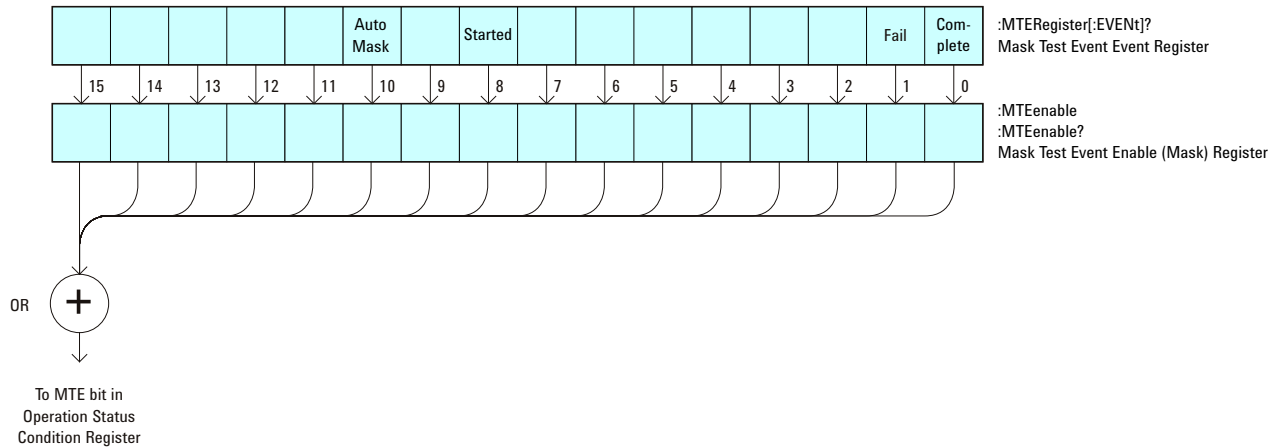

Table 50 Mask Test Event Event Register

Bit	Name	Description	When Set (1 = High = True), Indicates:
15-11	---	---	(Not used.)
10	Auto Mask	Auto Mask Created	Auto mask creation completed.
9	---	---	(Not used.)
8	Started	Mask Testing Started	Mask testing started.
7-2	---	---	(Not used.)
1	Fail	Mask Test Fail	The mask test failed.
0	Complete	Mask Test Complete	The mask test is complete.

Return Format <value><NL>
 <value> ::= integer in NR1 format.

- See Also**
- "Introduction to Root (:) Commands" on page 141
 - ":CHANnel<n>:PROTection" on page 232
 - ":EXTernal:PROTection" on page 261

5 Commands by Subsystem

- ":OPEE (Operation Status Enable Register)" on page 163
- ":OPERegister:CONDition (Operation Status Condition Register)" on page 165
- ":OVLenable (Overload Event Enable Register)" on page 169
- ":OVLRegister (Overload Event Register)" on page 171
- "*STB (Read Status Byte)" on page 134
- "*SRE (Service Request Enable)" on page 132

:OPEE (Operation Status Enable Register)

C (see page 786)

Command Syntax :OPEE <mask>
 <mask> ::= 16-bit integer

The :OPEE command sets a mask in the Operation Status Enable register. Set any of the following bits to "1" to enable bit 7 in the Status Byte Register and potentially cause an SRQ (Service Request interrupt) to be generated.

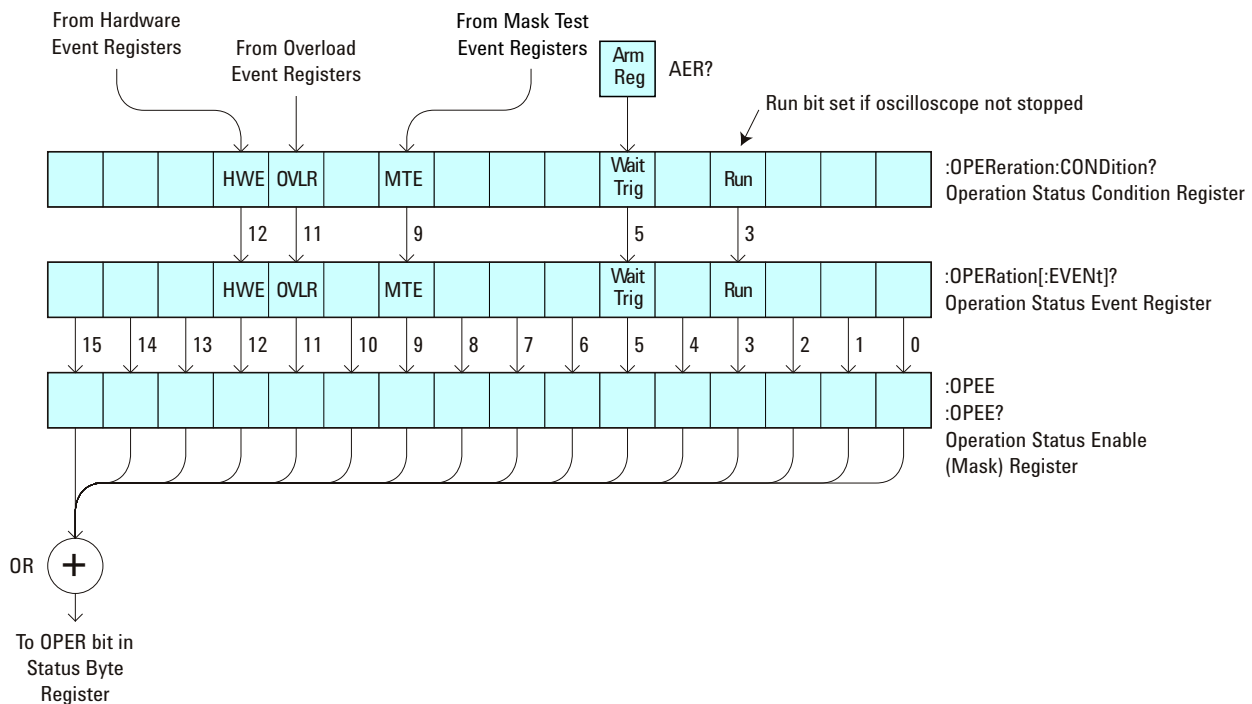

Table 51 Operation Status Enable Register (OPEE)

Bit	Name	Description	When Set (1 = High = True), Enables:
15-13	---	---	(Not used.)
12	HWE	Hardware Event	Event when hardware event occurs.
11	OVL	Overload	Event when 50Ω input overload occurs.
10	---	---	(Not used.)
9	MTE	Mask Test Event	Event when mask test event occurs.
8-6	---	---	(Not used.)

Table 51 Operation Status Enable Register (OPEE) (continued)

Bit	Name	Description	When Set (1 = High = True), Enables:
5	Wait Trig	Wait Trig	Event when the trigger is armed.
4	---	---	(Not used.)
3	Run	Running	Event when the oscilloscope is running (not stopped).
2-0	---	---	(Not used.)

Query Syntax :OPEE?

The :OPEE? query returns the current value contained in the Operation Status Enable register as an integer number.

Return Format <value><NL>

<value> ::= integer in NR1 format.

- See Also**
- ["Introduction to Root \(: \) Commands"](#) on page 141
 - [":AER \(Arm Event Register\)"](#) on page 143
 - [":CHANnel<n>:PROTection"](#) on page 232
 - [":EXTeRnal:PROTection"](#) on page 261
 - [":OPERegister\[:EVENT\] \(Operation Status Event Register\)"](#) on page 167
 - [":OVLenable \(Overload Event Enable Register\)"](#) on page 169
 - [":OVLRegister \(Overload Event Register\)"](#) on page 171
 - ["*STB \(Read Status Byte\)"](#) on page 134
 - ["*SRE \(Service Request Enable\)"](#) on page 132

:OPERRegister:CONDition (Operation Status Condition Register)

C (see page 786)

Query Syntax :OPERRegister:CONDition?

The :OPERRegister:CONDition? query returns the integer value contained in the Operation Status Condition Register.

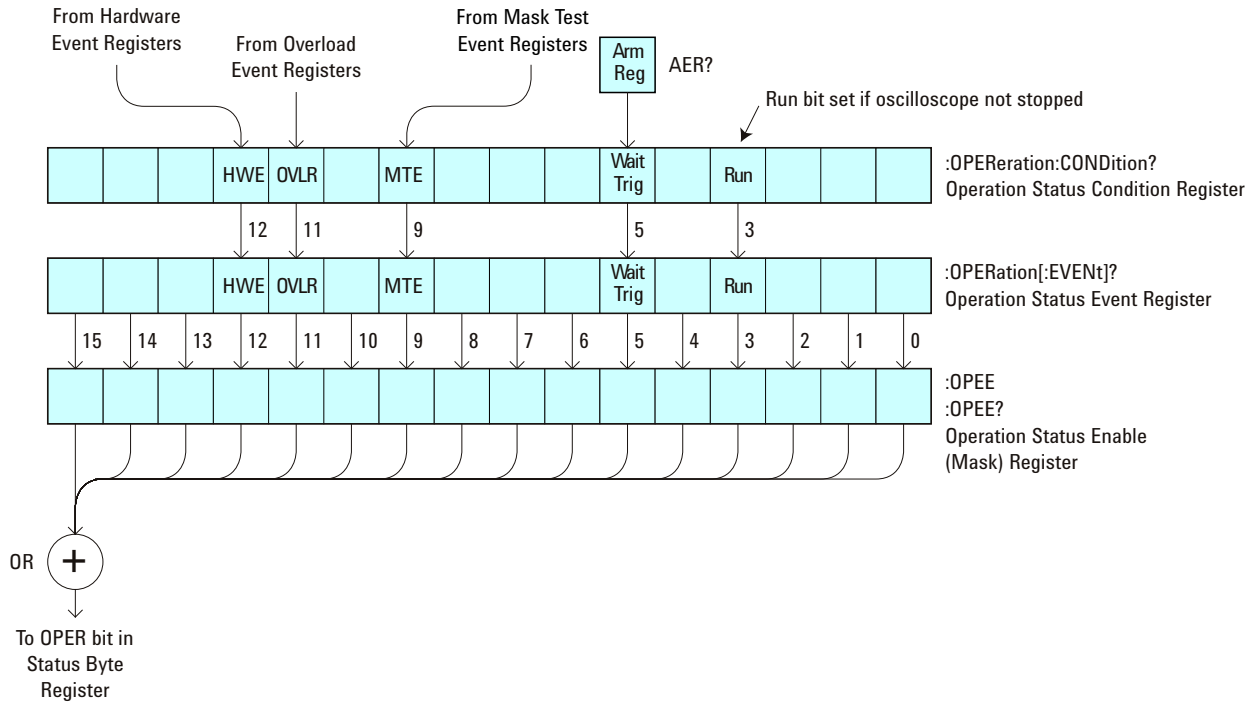

Table 52 Operation Status Condition Register

Bit	Name	Description	When Set (1 = High = True), Indicates:
15-13	---	---	(Not used.)
12	HWE	Hardware Event	A hardware event has occurred..
11	OVLRL	Overload	A 50Ω input overload has occurred.
10	---	---	(Not used.)
9	MTE	Mask Test Event	A mask test event has occurred.
8-6	---	---	(Not used.)
5	Wait Trig	Wait Trig	The trigger is armed (set by the Trigger Armed Event Register (TER)).
4	---	---	(Not used.)

Table 52 Operation Status Condition Register (continued)

Bit	Name	Description	When Set (1 = High = True), Indicates:
3	Run	Running	The oscilloscope is running (not stopped).
2-0	---	---	(Not used.)

Return Format <value><NL>

<value> ::= integer in NR1 format.

- See Also**
- ["Introduction to Root \(: \) Commands"](#) on page 141
 - [":CHANnel<n>:PROTection"](#) on page 232
 - [":EXTeRnal:PROTection"](#) on page 261
 - [":OPEE \(Operation Status Enable Register\)"](#) on page 163
 - [":OPERegister\[:EVENT\] \(Operation Status Event Register\)"](#) on page 167
 - [":OVLenable \(Overload Event Enable Register\)"](#) on page 169
 - [":OVLRegister \(Overload Event Register\)"](#) on page 171
 - ["*STB \(Read Status Byte\)"](#) on page 134
 - ["*SRE \(Service Request Enable\)"](#) on page 132
 - [":HWERegister\[:EVENT\] \(Hardware Event Event Register\)"](#) on page 156
 - [":HWEenable \(Hardware Event Enable Register\)"](#) on page 152
 - [":MTERegister\[:EVENT\] \(Mask Test Event Event Register\)"](#) on page 161
 - [":MTEenable \(Mask Test Event Enable Register\)"](#) on page 159

:OPERRegister[:EVENT] (Operation Status Event Register)

C (see page 786)

Query Syntax :OPERRegister[:EVENT]?

The :OPERRegister[:EVENT]? query returns the integer value contained in the Operation Status Event Register.

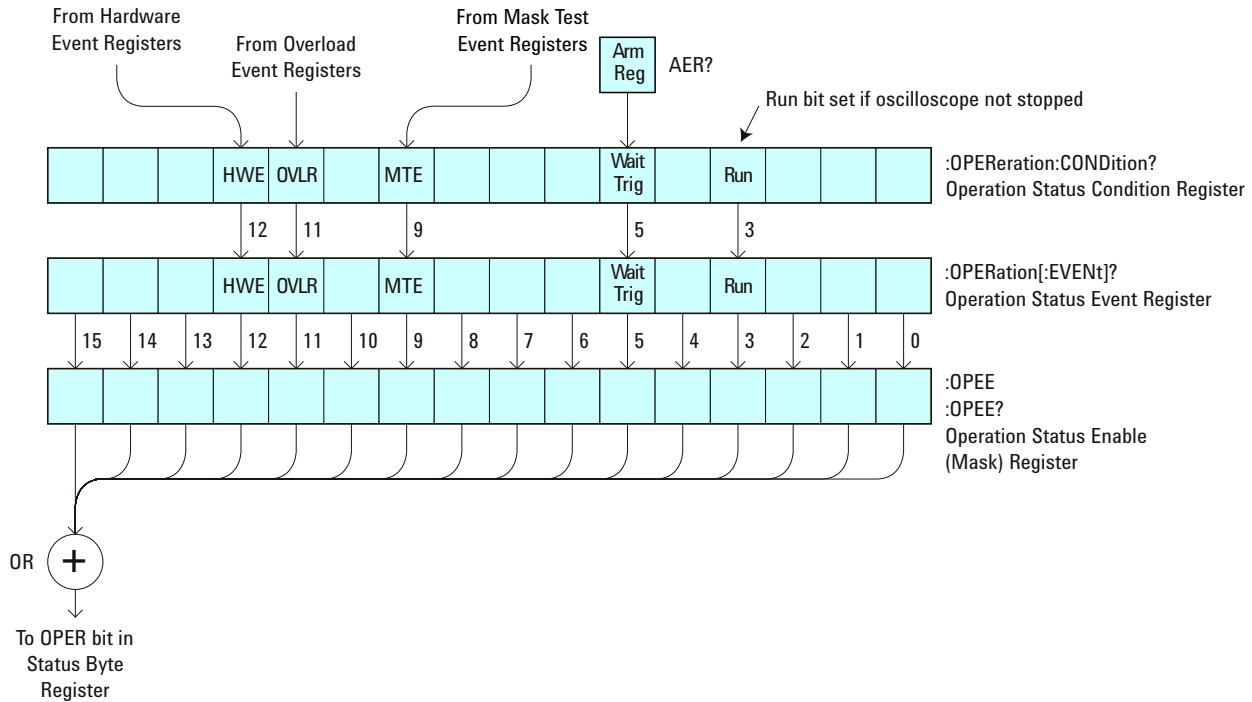

Table 53 Operation Status Event Register

Bit	Name	Description	When Set (1 = High = True), Indicates:
15-13	---	---	(Not used.)
12	HWE	Hardware Event	A hardware event has occurred.
11	OVL	Overload	A 50Ω input overload has occurred.
10	---	---	(Not used.)
9	MTE	Mask Test Event	A mask test event has occurred.
8-6	---	---	(Not used.)
5	Wait Trig	Wait Trig	The trigger is armed (set by the Trigger Armed Event Register (TER)).
4	---	---	(Not used.)

Table 53 Operation Status Event Register (continued)

Bit	Name	Description	When Set (1 = High = True), Indicates:
3	Run	Running	The oscilloscope has gone from a stop state to a single or running state.
2-0	---	---	(Not used.)

Return Format <value><NL>

<value> ::= integer in NR1 format.

- See Also**
- ["Introduction to Root \(: \) Commands"](#) on page 141
 - [":CHANnel<n>:PROTection"](#) on page 232
 - [":EXTeRnal:PROTection"](#) on page 261
 - [":OPEE \(Operation Status Enable Register\)"](#) on page 163
 - [":OPERegister:CONDition \(Operation Status Condition Register\)"](#) on page 165
 - [":OVLenable \(Overload Event Enable Register\)"](#) on page 169
 - [":OVLRegister \(Overload Event Register\)"](#) on page 171
 - ["*STB \(Read Status Byte\)"](#) on page 134
 - ["*SRE \(Service Request Enable\)"](#) on page 132
 - [":HWERegister\[:EVENT\] \(Hardware Event Event Register\)"](#) on page 156
 - [":HWEenable \(Hardware Event Enable Register\)"](#) on page 152
 - [":MTERegister\[:EVENT\] \(Mask Test Event Event Register\)"](#) on page 161
 - [":MTEenable \(Mask Test Event Enable Register\)"](#) on page 159

:OVLenable (Overload Event Enable Register)

C (see page 786)

Command Syntax :OVLenable <enable_mask>
 <enable_mask> ::= 16-bit integer

The overload enable mask is an integer representing an input as described in the following table.

The :OVLenable command sets the mask in the Overload Event Enable Register and enables the reporting of the Overload Event Register. If an overvoltage is sensed on a 50Ω input, the input will automatically switch to 1 MΩ input impedance. If enabled, such an event will set bit 11 in the Operation Status Register.

NOTE

You can set analog channel input impedance to 50Ω on the 300 MHz, 500 MHz, and 1 GHz bandwidth oscilloscope models. On these same bandwidth models, if there are only two analog channels, you can also set external trigger input impedance to 50Ω.

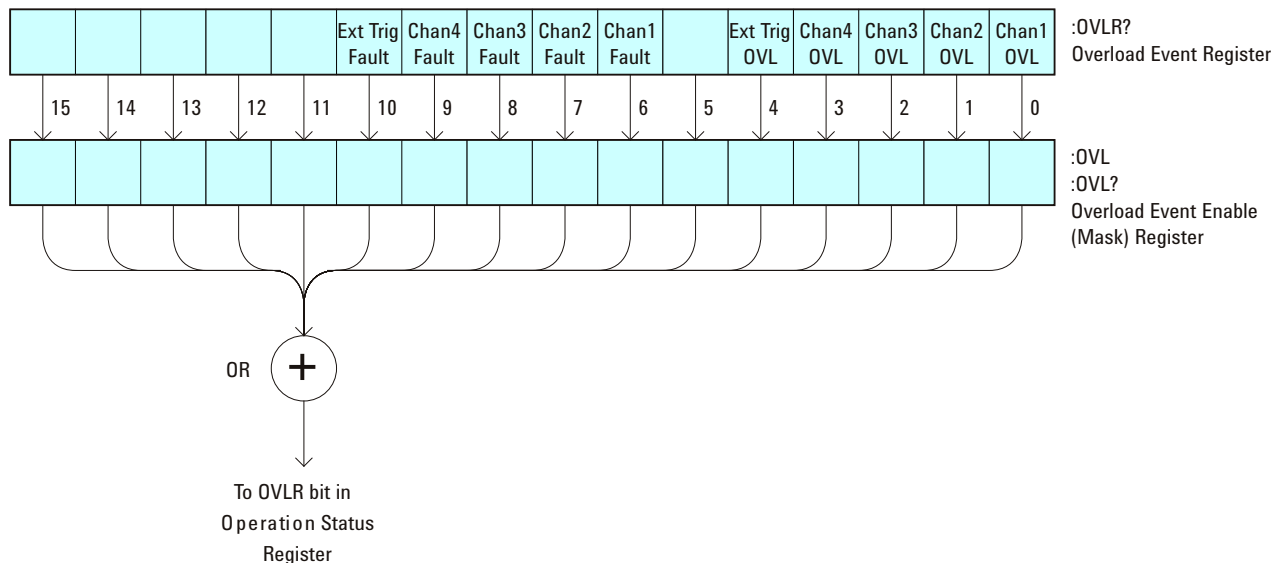

Table 54 Overload Event Enable Register (OVL)

Bit	Description	When Set (1 = High = True), Enables:
15-11	---	(Not used.)
10	External Trigger Fault	Event when fault occurs on External Trigger input.
9	Channel 4 Fault	Event when fault occurs on Channel 4 input.
8	Channel 3 Fault	Event when fault occurs on Channel 3 input.

Table 54 Overload Event Enable Register (OVL) (continued)

Bit	Description	When Set (1 = High = True), Enables:
7	Channel 2 Fault	Event when fault occurs on Channel 2 input.
6	Channel 1 Fault	Event when fault occurs on Channel 1 input.
5	---	(Not used.)
4	External Trigger OVL	Event when overload occurs on External Trigger input.
3	Channel 4 OVL	Event when overload occurs on Channel 4 input.
2	Channel 3 OVL	Event when overload occurs on Channel 3 input.
1	Channel 2 OVL	Event when overload occurs on Channel 2 input.
0	Channel 1 OVL	Event when overload occurs on Channel 1 input.

Query Syntax :OVLenable?

The :OVLenable query returns the current enable mask value contained in the Overload Event Enable Register.

Return Format <enable_mask><NL>

<enable_mask> ::= integer in NR1 format.

- See Also**
- "[Introduction to Root \(:\) Commands](#)" on page 141
 - "[:CHANnel<n>:PROTection](#)" on page 232
 - "[:EXTeRnal:PROTection](#)" on page 261
 - "[:OPEE \(Operation Status Enable Register\)](#)" on page 163
 - "[:OPERegister:CONDition \(Operation Status Condition Register\)](#)" on page 165
 - "[:OPERegister\[:EVENT\] \(Operation Status Event Register\)](#)" on page 167
 - "[:OVLRegister \(Overload Event Register\)](#)" on page 171
 - "[*STB \(Read Status Byte\)](#)" on page 134
 - "[*SRE \(Service Request Enable\)](#)" on page 132

:OVLRegister (Overload Event Register)

C (see page 786)

Query Syntax :OVLRegister?

The :OVLRegister query returns the overload protection value stored in the Overload Event Register (OVL). If an overvoltage is sensed on a 50Ω input, the input will automatically switch to 1 MΩ input impedance. A "1" indicates an overload has occurred.

NOTE

You can set analog channel input impedance to 50Ω on the 300 MHz, 500 MHz, and 1 GHz bandwidth oscilloscope models. On these same bandwidth models, if there are only two analog channels, you can also set external trigger input impedance to 50Ω.

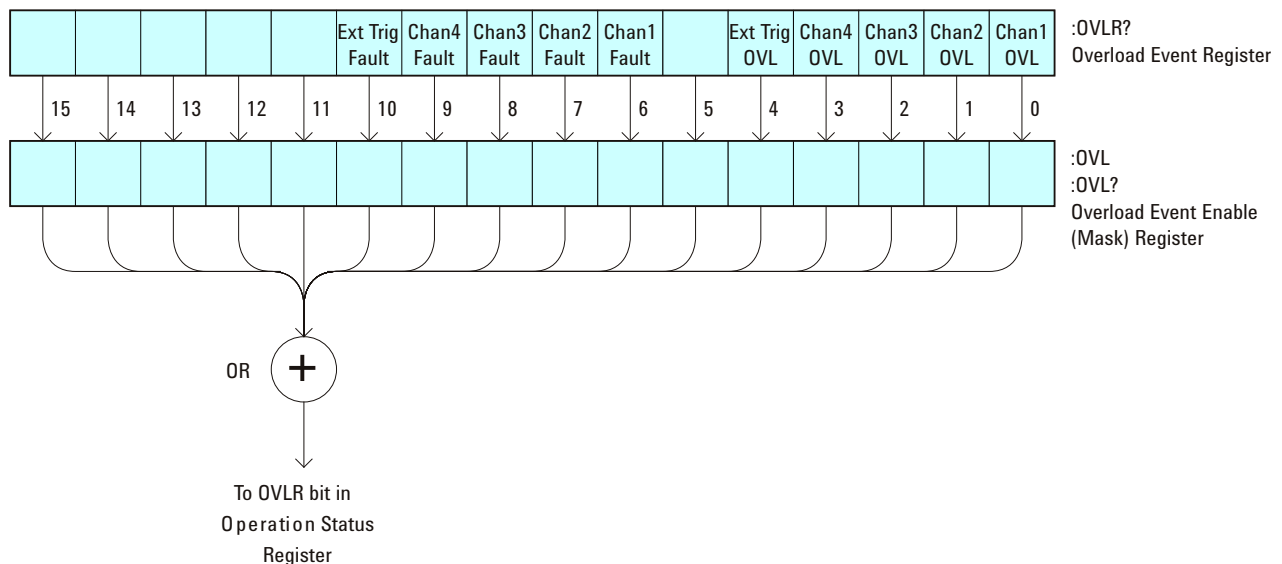

Table 55 Overload Event Register (OVL)

Bit	Description	When Set (1 = High = True), Indicates:
15-11	---	(Not used.)
10	External Trigger Fault	Fault has occurred on External Trigger input.
9	Channel 4 Fault	Fault has occurred on Channel 4 input.
8	Channel 3 Fault	Fault has occurred on Channel 3 input.
7	Channel 2 Fault	Fault has occurred on Channel 2 input.
6	Channel 1 Fault	Fault has occurred on Channel 1 input.
5	---	(Not used.)

Table 55 Overload Event Register (OVLr) (continued)

Bit	Description	When Set (1 = High = True), Indicates:
4	External Trigger OVL	Overload has occurred on External Trigger input.
3	Channel 4 OVL	Overload has occurred on Channel 4 input.
2	Channel 3 OVL	Overload has occurred on Channel 3 input.
1	Channel 2 OVL	Overload has occurred on Channel 2 input.
0	Channel 1 OVL	Overload has occurred on Channel 1 input.

Return Format

<value><NL>

<value> ::= integer in NR1 format.

See Also

- ["Introduction to Root \(: \) Commands"](#) on page 141
- [":CHANnel<n>:PROTection"](#) on page 232
- [":EXTernal:PROTection"](#) on page 261
- [":OPEE \(Operation Status Enable Register\)"](#) on page 163
- [":OVLenable \(Overload Event Enable Register\)"](#) on page 169
- ["*STB \(Read Status Byte\)"](#) on page 134
- ["*SRE \(Service Request Enable\)"](#) on page 132

:PRINt

C (see [page 786](#))

Command Syntax

```
:PRINt [<options>]
```

```
<options> ::= [<print option>][,...,<print option>]
```

```
<print option> ::= {COLor | GRAYscale | PRINter0 | BMP8bit | BMP | PNG  
                  | NOFactors | FACTors}
```

The <print option> parameter may be repeated up to 5 times.

The PRINt command formats the output according to the currently selected format (device). If an option is not specified, the value selected in the Print Config menu is used. Refer to "[:HARDcopy:FORMat](#)" on page 709 for more information.

See Also

- "[Introduction to Root \(:\) Commands](#)" on page 141
- "[Introduction to :HARDcopy Commands](#)" on page 282
- "[:HARDcopy:FORMat](#)" on page 709
- "[:HARDcopy:FACTors](#)" on page 285
- "[:HARDcopy:GRAYscale](#)" on page 710
- "[:DISPlay:DATA](#)" on page 247

:RUN

C (see [page 786](#))

Command Syntax

:RUN

The :RUN command starts repetitive acquisitions. This is the same as pressing the Run key on the front panel.

- See Also**
- ["Introduction to Root \(: \) Commands"](#) on page 141
 - [":SINGLE"](#) on page 176
 - [":STOP"](#) on page 178

Example Code

```
' RUN_STOP - (not executed in this example)
' - RUN starts the data acquisition for the active waveform display.
' - STOP stops the data acquisition and turns off AUTOSTORE.
' myScope.WriteString ":RUN"      ' Start data acquisition.
' myScope.WriteString ":STOP"     ' Stop the data acquisition.
```

Example program from the start: ["VISA COM Example in Visual Basic"](#) on page 812

:SERial

N (see [page 786](#))

Query Syntax :SERial?

The :SERial? query returns the serial number of the instrument.

Return Format: Unquoted string<NL>

See Also • ["Introduction to Root \(: \) Commands"](#) on page 141

:SINGle

C (see [page 786](#))

Command Syntax :SINGle

The :SINGle command causes the instrument to acquire a single trigger of data. This is the same as pressing the Single key on the front panel.

- See Also**
- ["Introduction to Root \(:\) Commands"](#) on page 141
 - [":RUN"](#) on page 174
 - [":STOP"](#) on page 178

:STATus

N (see [page 786](#))

Query Syntax

```
:STATus? <source>
```

```
<source> ::= {CHANnel<n> | FUNCTION | MATH | SBUS} for the DSO models
```

```
<source> ::= {CHANnel<n> | DIGital0,..,DIGital15 | POD{1 | 2}
              | BUS{1 | 2} | FUNCTION | MATH | SBUS} for the MSO models
```

```
<n> ::= {1 | 2 | 3 | 4} for the four channel oscilloscope models
```

```
<n> ::= {1 | 2} for the two channel oscilloscope models
```

The :STATus? query reports whether the channel, function, trace memory, or serial decode bus specified by <source> is displayed.

NOTE

MATH is an alias for FUNCTION.

Return Format

```
<value><NL>
```

```
<value> ::= {1 | 0}
```

See Also

- ["Introduction to Root \(: \) Commands"](#) on page 141
- [":BLANK"](#) on page 148
- [":CHANnel<n>:DISPlay"](#) on page 222
- [":DIGital<n>:DISPlay"](#) on page 239
- [":FUNCTION:DISPlay"](#) on page 268
- [":POD<n>:DISPlay"](#) on page 393
- [":VIEW"](#) on page 180

:STOP

C (see [page 786](#))

Command Syntax :STOP

The :STOP command stops the acquisition. This is the same as pressing the Stop key on the front panel.

- See Also**
- ["Introduction to Root \(:\) Commands"](#) on page 141
 - [":RUN"](#) on page 174
 - [":SINGLE"](#) on page 176

- Example Code**
- ["Example Code"](#) on page 174

:TER (Trigger Event Register)

C (see [page 786](#))

Query Syntax :TER?

The :TER? query reads the Trigger Event Register. After the Trigger Event Register is read, it is cleared. A one indicates a trigger has occurred. A zero indicates a trigger has not occurred.

The Trigger Event Register is summarized in the TRG bit of the Status Byte Register (STB). A Service Request (SRQ) can be generated when the TRG bit of the Status Byte transitions, and the TRG bit is set in the Service Request Enable register. The Trigger Event Register must be cleared each time you want a new service request to be generated.

Return Format <value><NL>

<value> ::= {1 | 0}; a 16-bit integer in NR1 format.

- See Also**
- ["Introduction to Root \(: \) Commands"](#) on page 141
 - ["*SRE \(Service Request Enable\)"](#) on page 132
 - ["*STB \(Read Status Byte\)"](#) on page 134

:VIEW

N (see [page 786](#))

Command Syntax

```
:VIEW <source>
```

```
<source> ::= {CHANnel<n> | PMEMory0,...,PMEMory9 | FUNctIon | MATH  
            | SBUS} for DSO models
```

```
<source> ::= {CHANnel<n> | DIGital0,...,DIGital15 | PMEMory0,...,PMEMory9  
            | POD{1 | 2} | BUS{1 | 2} | FUNctIon | MATH | SBUS} for  
            MSO models
```

```
<n> ::= {1 | 2 | 3 | 4} for the four channel oscilloscope models
```

```
<n> ::= {1 | 2} for the two channel oscilloscope models
```

The :VIEW command turns on the specified channel, function, trace memory, or serial decode bus.

NOTE

MATH is an alias for FUNctIon.

- See Also**
- "[Introduction to Root \(:\)](#) Commands" on page 141
 - "[:BLANK](#)" on page 148
 - "[:CHANnel<n>:DISPlay](#)" on page 222
 - "[:DIGital<n>:DISPlay](#)" on page 239
 - "[:FUNctIon:DISPlay](#)" on page 268
 - "[:POD<n>:DISPlay](#)" on page 393
 - "[:STATus](#)" on page 177

Example Code

```
' VIEW_BLANK - (not executed in this example)
' - VIEW turns on (starts displaying) a channel or pixel memory.
' - BLANK turns off (stops displaying) a channel or pixel memory.
' myScope.WriteString ":BLANK CHANNEL1"      ' Turn channel 1 off.
' myScope.WriteString ":VIEW CHANNEL1"      ' Turn channel 1 on.
```

Example program from the start: "[VISA COM Example in Visual Basic](#)" on page 812

:ACQUIRE Commands

Set the parameters for acquiring and storing data. See "Introduction to :ACQUIRE Commands" on page 181.

Table 56 :ACQUIRE Commands Summary

Command	Query	Options and Query Returns
n/a	:ACQUIRE:AALias? (see page 183)	{1 0}
:ACQUIRE:COMPLETE <complete> (see page 184)	:ACQUIRE:COMPLETE? (see page 184)	<complete> ::= 100; an integer in NR1 format
:ACQUIRE:COUNT <count> (see page 185)	:ACQUIRE:COUNT? (see page 185)	<count> ::= an integer from 2 to 65536 in NR1 format
:ACQUIRE:DAALias <mode> (see page 186)	:ACQUIRE:DAALias? (see page 186)	<mode> ::= {DISable AUTO}
:ACQUIRE:MODE <mode> (see page 187)	:ACQUIRE:MODE? (see page 187)	<mode> ::= {RTIME ETIME SEGmented}
n/a	:ACQUIRE:POINTs? (see page 188)	<# points> ::= an integer in NR1 format
:ACQUIRE:RSIGNAL <ref_signal_mode> (see page 189)	:ACQUIRE:RSIGNAL? (see page 189)	<ref_signal_mode> ::= {OFF OUT IN}
:ACQUIRE:SEGmented:ANALyze (see page 190)	n/a	n/a (with Option SGM)
:ACQUIRE:SEGmented:COUNT <count> (see page 191)	:ACQUIRE:SEGmented:COUNT? (see page 191)	<count> ::= an integer from 2 to 2000 (w/8M memory) in NR1 format (with Option SGM)
:ACQUIRE:SEGmented:INDEX <index> (see page 192)	:ACQUIRE:SEGmented:INDEX? (see page 192)	<index> ::= an integer from 2 to 2000 (w/8M memory) in NR1 format (with Option SGM)
n/a	:ACQUIRE:SRATE? (see page 195)	<sample_rate> ::= sample rate (samples/s) in NR3 format
:ACQUIRE:TYPE <type> (see page 196)	:ACQUIRE:TYPE? (see page 196)	<type> ::= {NORMAL AVERAGE HRESolution PEAK}

Introduction to :ACQUIRE Commands The ACQUIRE subsystem controls the way in which waveforms are acquired. These acquisition types are available: normal, averaging, peak detect, and high resolution. Two acquisition modes are available: real-time mode, and equivalent-time mode.

Normal

The `:ACQUIRE:TYPE NORMAL` command sets the oscilloscope in the normal acquisition mode. For the majority of user models and signals, `NORMAL` mode yields the best oscilloscope picture of the waveform.

Averaging

The `:ACQUIRE:TYPE AVERAGE` command sets the oscilloscope in the averaging mode. You can set the count by sending the `:ACQUIRE:COUNT` command followed by the number of averages. In this mode, the value for averages is an integer from 2 to 65536. The `COUNT` value determines the number of averages that must be acquired.

High-Resolution

The `:ACQUIRE:TYPE HRESOLUTION` command sets the oscilloscope in the high-resolution mode (also known as *smoothing*). This mode is used to reduce noise at slower sweep speeds where the digitizer samples faster than needed to fill memory for the displayed time range. Instead of decimating samples, they are averaged together to provide the value for one display point. The slower the sweep speed, the greater the number of samples that are averaged together for each display point.

Peak Detect

The `:ACQUIRE:TYPE PEAK` command sets the oscilloscope in the peak detect mode. In this mode, `:ACQUIRE:COUNT` has no meaning.

Real-time Mode

The `:ACQUIRE:MODE RTIME` command sets the oscilloscope in real-time mode. This mode is useful to inhibit equivalent time sampling at fast sweep speeds.

Equivalent-time Mode

The `:ACQUIRE:MODE ETIME` command sets the oscilloscope in equivalent-time mode.

Reporting the Setup

Use `:ACQUIRE?` to query setup information for the `ACQUIRE` subsystem.

Return Format

The following is a sample response from the `:ACQUIRE?` query. In this case, the query was issued following a `*RST` command.

```
:ACQ:MODE RTIM;TYPE NORM;COMP 100;COUNT 8;SEGM:COUN 2
```

:ACQUIRE:AALIAS

N (see [page 786](#))

Query Syntax :ACQUIRE:AALIAS?

The :ACQUIRE:AALIAS? query returns the current state of the oscilloscope acquisition anti-alias control. This control can be directly disabled or disabled automatically.

Return Format <value><NL>
<value> ::= {1 | 0}

- See Also**
- "[Introduction to :ACQUIRE Commands](#)" on page 181
 - "[:ACQUIRE:DAALIAS](#)" on page 186

:ACQUIRE:COMPLETE

C (see [page 786](#))

Command Syntax :ACQUIRE:COMPLETE <complete>
 <complete> ::= 100; an integer in NR1 format

The :ACQUIRE:COMPLETE command affects the operation of the :DIGITIZE command. It specifies the minimum completion criteria for an acquisition. The parameter determines the percentage of the time buckets that must be "full" before an acquisition is considered complete. If :ACQUIRE:TYPE is NORMAL, it needs only one sample per time bucket for that time bucket to be considered full.

The only legal value for the :COMPLETE command is 100. All time buckets must contain data for the acquisition to be considered complete.

Query Syntax :ACQUIRE:COMPLETE?

The :ACQUIRE:COMPLETE? query returns the completion criteria (100) for the currently selected mode.

Return Format <completion_criteria><NL>
 <completion_criteria> ::= 100; an integer in NR1 format

- See Also**
- ["Introduction to :ACQUIRE Commands"](#) on page 181
 - [":ACQUIRE:TYPE"](#) on page 196
 - [":DIGITIZE"](#) on page 150
 - [":WAVEFORM:POINTS"](#) on page 629

Example Code

```
' ACQUIRE_COMPLETE - Specifies the minimum completion criteria for
' an acquisition. The parameter determines the percentage of time
' buckets needed to be "full" before an acquisition is considered
' to be complete.
myScope.WriteString ":ACQUIRE:COMPLETE 100"
```

Example program from the start: ["VISA COM Example in Visual Basic"](#) on page 812

:ACquire:COUNT

C (see [page 786](#))

Command Syntax :ACquire:COUNT <count>
 <count> ::= integer in NR1 format

In averaging mode, the :ACquire:COUNT command specifies the number of values to be averaged for each time bucket before the acquisition is considered to be complete for that time bucket. When :ACquire:TYPE is set to AVERage, the count can be set to any value from 2 to 65536.

NOTE

The :ACquire:COUNT 1 command has been deprecated. The AVERage acquisition type with a count of 1 is functionally equivalent to the HRESolution acquisition type; however, you should select the high-resolution acquisition mode with the :ACquire:TYPE HRESolution command instead.

Query Syntax :ACquire:COUNT?

The :ACquire:COUNT? query returns the currently selected count value for averaging mode.

Return Format <count_argument><NL>
 <count_argument> ::= an integer from 2 to 65536 in NR1 format

- See Also**
- ["Introduction to :ACquire Commands"](#) on page 181
 - [":ACquire:TYPE"](#) on page 196
 - [":DIGitize"](#) on page 150
 - [":WAVEform:COUNT"](#) on page 625

:ACQUIRE:DAALIAS

N (see [page 786](#))

Command Syntax :ACQUIRE:DAALIAS <mode>
<mode> ::= {DISABLE | AUTO}

The :ACQUIRE:DAALIAS command sets the disable anti-alias mode of the oscilloscope.

When set to DISABLE, anti-alias is always disabled. This is good for cases where dithered data is not desired.

When set to AUTO, the oscilloscope turns off anti-alias control as needed. Such cases are when the FFT or differentiate math functions are silent. The :DIGITIZE command always turns off the anti-alias control as well.

Query Syntax :ACQUIRE:DAALIAS?

The :ACQUIRE:DAALIAS? query returns the oscilloscope's current disable anti-alias mode setting.

Return Format <mode><NL>

<mode> ::= {DIS | AUTO}

- See Also**
- "[Introduction to :ACQUIRE Commands](#)" on page 181
 - "[:ACQUIRE:AALIAS](#)" on page 183

:ACquire:MODE

C (see [page 786](#))

Command Syntax :ACquire:MODE <mode>

<mode> ::= {RTIME | ETIME | SEGmented}

The :ACquire:MODE command sets the acquisition mode of the oscilloscope.

- The :ACquire:MODE RTIME command sets the oscilloscope in real time mode. This mode is useful to inhibit equivalent time sampling at fast sweep speeds.

Real time mode is not available when averaging (:ACquire:TYPE AVERage).

NOTE

The obsolete command ACquire:TYPE:REALtime is functionally equivalent to sending ACquire:MODE RTIME; TYPE NORMal.

- The :ACquire:MODE ETIME command sets the oscilloscope in equivalent time mode.
- The :ACquire:MODE SEGmented command sets the oscilloscope in segmented memory mode.

Query Syntax :ACquire:MODE?

The :ACquire:MODE? query returns the acquisition mode of the oscilloscope.

Return Format <mode_argument><NL>

<mode_argument> ::= {RTIM | ETIM | SEGM}

- See Also**
- ["Introduction to :ACquire Commands"](#) on page 181
 - [":ACquire:TYPE"](#) on page 196

:ACQUIRE:POINTS

C (see [page 786](#))

Query Syntax :ACQUIRE:POINTS?

The :ACQUIRE:POINTS? query returns the number of data points that the hardware will acquire from the input signal. The number of points acquired is not directly controllable. To set the number of points to be transferred from the oscilloscope, use the command :WAVEFORM:POINTS. The :WAVEFORM:POINTS? query will return the number of points available to be transferred from the oscilloscope.

Return Format <points_argument><NL>

<points_argument> ::= an integer in NR1 format

- See Also**
- ["Introduction to :ACQUIRE Commands"](#) on page 181
 - [":DIGITIZE"](#) on page 150
 - [":WAVEFORM:POINTS"](#) on page 629

:ACquire:RSIGnal

N (see [page 786](#))

Command Syntax :ACquire:RSIGnal <ref_signal_mode>
 <ref_signal_mode> ::= {OFF | OUT | IN}

The :ACquire:RSIGnal command selects the 10 MHz reference signal mode.

- The OFF mode disables the oscilloscope's 10 MHz REF BNC connector.
- The OUT mode is used to synchronize the timebase of two or more instruments.
- The IN mode is used to supply a sample clock to the oscilloscope. A 10 MHz square or sine wave signal is input to the BNC connector labeled 10 MHz REF. The amplitude must be between 180 mV and 1 V, with an offset of between 0 V and 2 V.

CAUTION

Do not apply more than ± 15 V at the 10 MHz REF BNC connector on the rear panel, or damage to the instrument may occur.

Query Syntax :ACquire:RSIGnal?

The :ACquire:RSIGnal? query returns the current 10 MHz reference signal mode.

Return Format <ref_signal_mode><NL>
 <ref_signal_mode> ::= {OFF | OUT | IN}

- See Also**
- [":TIMEbase:REFClock"](#) on page 460
 - The *Agilent InfiniiVision 7000 Series Oscilloscope User's Guide* for information on using the 10 MHz reference clock.

:ACQUIRE:SEGMENTED:ANALYZE

N (see [page 786](#))

Command Syntax :ACQUIRE:SEGMENTED:ANALYZE

NOTE

This command is available when the segmented memory option (Option SGM) is enabled.

This command calculates measurement statistics and/or infinite persistence over all segments that have been acquired. It corresponds to the front panel **Analyze Segments** softkey which appears in both the Measurement Statistics and Segmented Memory Menus.

In order to use this command, the oscilloscope must be stopped and in segmented acquisition mode, with either quick measurements or infinite persistence on.

- See Also**
- [":ACQUIRE:MODE"](#) on page 187
 - [":ACQUIRE:SEGMENTED:COUNT"](#) on page 191
 - ["Introduction to :ACQUIRE Commands"](#) on page 181

:ACQUIRE:SEGMENTED:COUNT

N (see [page 786](#))

Command Syntax :ACQUIRE:SEGMENTED:COUNT <count>
 <count> ::= an integer from 2 to 2000 (w/8M memory) in NR1 format

NOTE

This command is available when the segmented memory option (Option SGM) is enabled.

The :ACQUIRE:SEGMENTED:COUNT command sets the number of memory segments to acquire.

The segmented memory acquisition mode is enabled with the :ACQUIRE:MODE command, and data is acquired using the :DIGITIZE, :SINGLE, or :RUN commands. The number of memory segments in the current acquisition is returned by the :WAVEFORM:SEGMENTED:COUNT? query.

The maximum number of segments may be limited by the memory depth of your oscilloscope. For example, an oscilloscope with 1M memory allows a maximum of 250 segments.

Query Syntax :ACQUIRE:SEGMENTED:COUNT?

The :ACQUIRE:SEGMENTED:COUNT? query returns the current count setting.

Return Format <count><NL>
 <count> ::= an integer from 2 to 2000 (w/8M memory) in NR1 format

- See Also**
- [":ACQUIRE:MODE"](#) on page 187
 - [":DIGITIZE"](#) on page 150
 - [":SINGLE"](#) on page 176
 - [":RUN"](#) on page 174
 - [":WAVEFORM:SEGMENTED:COUNT"](#) on page 636
 - [":ACQUIRE:SEGMENTED:ANALYZE"](#) on page 190
 - ["Introduction to :ACQUIRE Commands"](#) on page 181

Example Code • ["Example Code"](#) on page 192

:ACQUIRE:SEGMENTED:INDEX

N (see [page 786](#))

Command Syntax :ACQUIRE:SEGMENTED:INDEX <index>
 <index> ::= an integer from 2 to 2000 (w/8M memory) in NR1 format

NOTE

This command is available when the segmented memory option (Option SGM) is enabled.

The :ACQUIRE:SEGMENTED:INDEX command sets the index into the memory segments that have been acquired.

The segmented memory acquisition mode is enabled with the :ACQUIRE:MODE command. The number of segments to acquire is set using the :ACQUIRE:SEGMENTED:COUNT command, and data is acquired using the :DIGITIZE, :SINGLE, or :RUN commands. The number of memory segments that have been acquired is returned by the :WAVEFORM:SEGMENTED:COUNT? query. The time tag of the currently indexed memory segment is returned by the :WAVEFORM:SEGMENTED:TTAG? query.

The maximum number of segments may be limited by the memory depth of your oscilloscope. For example, an oscilloscope with 1M memory allows a maximum of 250 segments.

Query Syntax :ACQUIRE:SEGMENTED:INDEX?

The :ACQUIRE:SEGMENTED:INDEX? query returns the current segmented memory index setting.

Return Format <index><NL>
 <index> ::= an integer from 2 to 2000 (w/8M memory) in NR1 format

- See Also**
- [":ACQUIRE:MODE"](#) on page 187
 - [":ACQUIRE:SEGMENTED:COUNT"](#) on page 191
 - [":DIGITIZE"](#) on page 150
 - [":SINGLE"](#) on page 176
 - [":RUN"](#) on page 174
 - [":WAVEFORM:SEGMENTED:COUNT"](#) on page 636
 - [":WAVEFORM:SEGMENTED:TTAG"](#) on page 637
 - [":ACQUIRE:SEGMENTED:ANALYZE"](#) on page 190
 - ["Introduction to :ACQUIRE Commands"](#) on page 181

Example Code ' Segmented memory commands example.
 ' -----

```

Option Explicit

Public myMgr As VisaComLib.ResourceManager
Public myScope As VisaComLib.FormattedIO488
Public varQueryResult As Variant
Public strQueryResult As String

Private Declare Sub Sleep Lib "kernel32" (ByVal dwMilliseconds As Long)

Sub Main()

    On Error GoTo VisaComError

    ' Create the VISA COM I/O resource.
    Set myMgr = New VisaComLib.ResourceManager
    Set myScope = New VisaComLib.FormattedIO488
    Set myScope.IO = myMgr.Open("TCPIP0::130.29.70.228::inst0::INSTR")
    myScope.IO.Clear ' Clear the interface.

    ' Turn on segmented memory acquisition mode.
    myScope.WriteString ":ACQUIRE:MODE SEGMENTED"
    myScope.WriteString ":ACQUIRE:MODE?"
    strQueryResult = myScope.ReadString
    Debug.Print "Acquisition mode: " + strQueryResult

    ' Set the number of segments to 50.
    myScope.WriteString ":ACQUIRE:SEGMENTED:COUNT 50"
    myScope.WriteString ":ACQUIRE:SEGMENTED:COUNT?"
    strQueryResult = myScope.ReadString
    Debug.Print "Acquisition memory segments: " + strQueryResult

    ' If data will be acquired within the IO timeout:
    myScope.IO.Timeout = 10000
    myScope.WriteString ":DIGITIZE"
    Debug.Print ":DIGITIZE blocks until all segments acquired."
    myScope.WriteString ":WAVEFORM:SEGMENTED:COUNT?"
    varQueryResult = myScope.ReadNumber

    ' Or, to poll until the desired number of segments acquired:
    myScope.WriteString ":SINGLE"
    Debug.Print ":SINGLE does not block until all segments acquired."
    Do
        Sleep 100 ' Small wait to prevent excessive queries.
        myScope.WriteString ":WAVEFORM:SEGMENTED:COUNT?"
        varQueryResult = myScope.ReadNumber
    Loop Until varQueryResult = 50

    Debug.Print "Number of segments in acquired data: " _
        + FormatNumber(varQueryResult)

    Dim lngSegments As Long
    lngSegments = varQueryResult

    ' For each segment:
    Dim dblTimeTag As Double
    Dim lngI As Long

```

5 Commands by Subsystem

```
For lngI = lngSegments To 1 Step -1

    ' Set the segmented memory index.
    myScope.WriteString ":ACquire:SEGmented:INDEX " + CStr(lngI)
    myScope.WriteString ":ACquire:SEGmented:INDEX?"
    strQueryResult = myScope.ReadString
    Debug.Print "Acquisition memory segment index: " + strQueryResult

    ' Display the segment time tag.
    myScope.WriteString ":WAVEform:SEGmented:TTAG?"
    dblTimeTag = myScope.ReadNumber
    Debug.Print "Segment " + CStr(lngI) + " time tag: " _
        + FormatNumber(dblTimeTag, 12)

Next lngI

Exit Sub

VisaComError:
    MsgBox "VISA COM Error:" + vbCrLf + Err.Description

End Sub
```

:ACQUIRE:SRATE

N (see [page 786](#))

Query Syntax :ACQUIRE:SRATE?

The :ACQUIRE:SRATE? query returns the current oscilloscope acquisition sample rate. The sample rate is not directly controllable.

Return Format <sample_rate><NL>

<sample_rate> ::= sample rate in NR3 format

- See Also**
- ["Introduction to :ACQUIRE Commands"](#) on page 181
 - [":ACQUIRE:POINTS"](#) on page 188

:ACquire:TYPE

C (see [page 786](#))

Command Syntax :ACquire:TYPE <type>

<type> ::= {NORMal | AVERage | HRESolution | PEAK}

The :ACquire:TYPE command selects the type of data acquisition that is to take place. The acquisition types are: NORMal, AVERage, HRESolution, and PEAK.

- The :ACquire:TYPE NORMal command sets the oscilloscope in the normal mode.
- The :ACquire:TYPE AVERage command sets the oscilloscope in the averaging mode. You can set the count by sending the :ACquire:COUNT command followed by the number of averages. In this mode, the value for averages is an integer from 1 to 65536. The COUNT value determines the number of averages that must be acquired.

Setting the :ACquire:TYPE to AVERage automatically sets :ACquire:MODE to ETIME (equivalent time sampling).

The AVERage type is not available when in segmented memory mode (:ACquire:MODE SEGmented).

- The :ACquire:TYPE HRESolution command sets the oscilloscope in the high-resolution mode (also known as *smoothing*). This mode is used to reduce noise at slower sweep speeds where the digitizer samples faster than needed to fill memory for the displayed time range.

For example, if the digitizer samples at 200 MSa/s, but the effective sample rate is 1 MSa/s (because of a slower sweep speed), only 1 out of every 200 samples needs to be stored. Instead of storing one sample (and throwing others away), the 200 samples are averaged together to provide the value for one display point. The slower the sweep speed, the greater the number of samples that are averaged together for each display point.

- The :ACquire:TYPE PEAK command sets the oscilloscope in the peak detect mode. In this mode, :ACquire:COUNT has no meaning.

NOTE

The obsolete command ACquire:TYPE:REALtime is functionally equivalent to sending ACquire:MODE RTIME; TYPE NORMal.

Query Syntax :ACquire:TYPE?

The :ACquire:TYPE? query returns the current acquisition type.

Return Format <acq_type><NL>

<acq_type> ::= {NORM | AVER | HRES | PEAK}

- See Also**
- ["Introduction to :ACQUIRE Commands"](#) on page 181
 - [":ACQUIRE:COUNT"](#) on page 185
 - [":ACQUIRE:MODE"](#) on page 187
 - [":DIGITIZE"](#) on page 150
 - [":WAVEFORM:TYPE"](#) on page 643
 - [":WAVEFORM:PREAmble"](#) on page 633

Example Code

```
' ACQUIRE_TYPE - Sets the acquisition mode, which can be NORMAL,  
' PEAK, or AVERAGE.  
myScope.WriteString ":ACQUIRE:TYPE NORMAL"
```

Example program from the start: ["VISA COM Example in Visual Basic"](#) on page 812

:BUS<n> Commands

Control all oscilloscope functions associated with buses made up of digital channels. See "Introduction to :BUS<n> Commands" on page 199.

Table 57 :BUS<n> Commands Summary

Command	Query	Options and Query Returns
:BUS<n>:BIT<m> {{0 OFF} {1 ON}} (see page 200)	:BUS<n>:BIT<m>? (see page 200)	{0 1} <n> ::= 1 or 2; an integer in NR1 format <m> ::= 0-15; an integer in NR1 format
:BUS<n>:BITS <channel_list>, {{0 OFF} {1 ON}} (see page 201)	:BUS<n>:BITS? (see page 201)	<channel_list>, {0 1} <channel_list> ::= (@<m>, <m>:<m> ...) where "," is separator and ":" is range <n> ::= 1 or 2; an integer in NR1 format <m> ::= 0-15; an integer in NR1 format
:BUS<n>:CLear (see page 203)	n/a	<n> ::= 1 or 2; an integer in NR1 format
:BUS<n>:DISPlay {{0 OFF} {1 ON}} (see page 204)	:BUS<n>:DISPlay? (see page 204)	{0 1} <n> ::= 1 or 2; an integer in NR1 format
:BUS<n>:LABel <string> (see page 205)	:BUS<n>:LABel? (see page 205)	<string> ::= quoted ASCII string up to 10 characters <n> ::= 1 or 2; an integer in NR1 format
:BUS<n>:MASK <mask> (see page 206)	:BUS<n>:MASK? (see page 206)	<mask> ::= 32-bit integer in decimal, <nondecimal>, or <string> <nondecimal> ::= #Hnn...n where n ::= {0,...,9 A,...,F} for hexadecimal <nondecimal> ::= #Bnn...n where n ::= {0 1} for binary <string> ::= "0xnn...n" where n ::= {0,...,9 A,...,F} for hexadecimal <n> ::= 1 or 2; an integer in NR1 format

**Introduction to
:BUS<n>
Commands**

<n> ::= {1 | 2}

The BUS subsystem commands control the viewing, labeling, and digital channel makeup of two possible buses.

NOTE

These commands are only valid for the MSO models.

Reporting the Setup

Use :BUS<n>? to query setup information for the BUS subsystem.

Return Format

The following is a sample response from the :BUS1? query. In this case, the query was issued following a *RST command.

```
:BUS1:DISP 0;LAB "BUS1";MASK +255
```

:BUS<n>:BIT<m>

N (see [page 786](#))

Command Syntax :BUS<n>:BIT<m> <display>

<display> ::= {{1 | ON} | {0 | OFF}}

<n> ::= An integer, 1 or 2, is attached as a suffix to BUS and defines the bus that is affected by the command.

<m> ::= An integer, 0,...,15, is attached as a suffix to BIT and defines the digital channel that is affected by the command.

The :BUS<n>:BIT<m> command includes or excludes the selected bit as part of the definition for the selected bus. If the parameter is a 1 (ON), the bit is included in the definition. If the parameter is a 0 (OFF), the bit is excluded from the definition. *Note:* BIT0-15 correspond to DIGital0-15.

NOTE

This command is only valid for the MSO models.

Query Syntax :BUS<n>:BIT<m>?

The :BUS<n>:BIT<m>? query returns the value indicating whether the specified bit is included or excluded from the specified bus definition.

Return Format <display><NL>

<display> ::= {0 | 1}

- See Also**
- "[Introduction to :BUS<n> Commands](#)" on page 199
 - "[:BUS<n>:BITS](#)" on page 201
 - "[:BUS<n>:CLEar](#)" on page 203
 - "[:BUS<n>:DISPlay](#)" on page 204
 - "[:BUS<n>:LABel](#)" on page 205
 - "[:BUS<n>:MASK](#)" on page 206

Example Code

```
' Include digital channel 1 in bus 1:
myScope.WriteString ":BUS1:BIT1 ON"
```

:BUS<n>:BITS

N (see [page 786](#))

Command Syntax :BUS<n>:BITS <channel_list>, <display>

<channel_list> ::= (@<m>,<m>:<m>, ...) where commas separate bits and colons define bit ranges.

<m> ::= An integer, 0,...,15, defines a digital channel affected by the command.

<display> ::= {{1 | ON} | {0 | OFF}}

<n> ::= An integer, 1 or 2, is attached as a suffix to BUS and defines the bus that is affected by the command.

The :BUS<n>:BITS command includes or excludes the selected bits in the channel list in the definition of the selected bus. If the parameter is a 1 (ON) then the bits in the channel list are included as part of the selected bus definition. If the parameter is a 0 (OFF) then the bits in the channel list are excluded from the definition of the selected bus.

NOTE

This command is only valid for the MSO models.

Query Syntax :BUS<n>:BITS?

The :BUS<n>:BITS? query returns the definition for the specified bus.

Return Format <channel_list>, <display><NL>

<channel_list> ::= (@<m>,<m>:<m>, ...) where commas separate bits and colons define bit ranges.

<display> ::= {0 | 1}

- See Also**
- ["Introduction to :BUS<n> Commands"](#) on page 199
 - [":BUS<n>:BIT<m>"](#) on page 200
 - [":BUS<n>:CLEar"](#) on page 203
 - [":BUS<n>:DISPlay"](#) on page 204
 - [":BUS<n>:LABel"](#) on page 205
 - [":BUS<n>:MASK"](#) on page 206

Example Code

```
' Include digital channels 1, 2, 4, 5, 6, 7, 8, and 9 in bus 1:
myScope.WriteString ":BUS1:BITS (@1,2,4:9), ON"

' Include digital channels 1, 5, 7, and 9 in bus 1:
myScope.WriteString ":BUS1:BITS (@1,5,7,9), ON"

' Include digital channels 1 through 15 in bus 1:
myScope.WriteString ":BUS1:BITS (@1:15), ON"
```

5 Commands by Subsystem

```
' Include digital channels 1 through 5, 8, and 14 in bus 1:  
myScope.WriteString ":BUS1:BITS (@1:5,8,14), ON"
```

:BUS<n>:CLEAr

N (see [page 786](#))

Command Syntax :BUS<n>:CLEAr

<n> ::= An integer, 1 or 2, is attached as a suffix to BUS and defines the bus that is affected by the command.

The :BUS<n>:CLEAr command excludes all of the digital channels from the selected bus definition.

NOTE

This command is only valid for the MSO models.

- See Also**
- ["Introduction to :BUS<n> Commands"](#) on page 199
 - [":BUS<n>:BIT<m>"](#) on page 200
 - [":BUS<n>:BITS"](#) on page 201
 - [":BUS<n>:DISPlay"](#) on page 204
 - [":BUS<n>:LABel"](#) on page 205
 - [":BUS<n>:MASK"](#) on page 206

:BUS<n>:DISPlay

N (see [page 786](#))

Command Syntax :BUS<n>:DISplay <value>
<value> ::= {{1 | ON} | {0 | OFF}}

<n> ::= An integer, 1 or 2, is attached as a suffix to BUS and defines the bus that is affected by the command.

The :BUS<n>:DISPlay command enables or disables the view of the selected bus.

NOTE

This command is only valid for the MSO models.

Query Syntax :BUS<n>:DISPlay?

The :BUS<n>:DISPlay? query returns the display value of the selected bus.

Return Format <value><NL>
<value> ::= {0 | 1}

- See Also**
- ["Introduction to :BUS<n> Commands"](#) on page 199
 - [":BUS<n>:BIT<m>"](#) on page 200
 - [":BUS<n>:BITS"](#) on page 201
 - [":BUS<n>:CLEar"](#) on page 203
 - [":BUS<n>:LABel"](#) on page 205
 - [":BUS<n>:MASK"](#) on page 206

:BUS<n>:LABel

N (see [page 786](#))

Command Syntax :BUS<n>:LABel <quoted_string>

<quoted_string> ::= any series of 10 or less characters as a quoted ASCII string.

<n> ::= An integer, 1 or 2, is attached as a suffix to BUS and defines the bus that is affected by the command.

The :BUS<n>:LABel command sets the bus label to the quoted string. Setting a label for a bus will also result in the name being added to the label list.

NOTE

This command is only valid for the MSO models.

NOTE

Label strings are 10 characters or less, and may contain any commonly used ASCII characters. Labels with more than 10 characters are truncated to 10 characters.

Query Syntax :BUS<n>:LABel?

The :BUS<n>:LABel? query returns the name of the specified bus.

Return Format <quoted_string><NL>

<quoted_string> ::= any series of 10 or less characters as a quoted ASCII string.

- See Also**
- ["Introduction to :BUS<n> Commands"](#) on page 199
 - [":BUS<n>:BIT<m>"](#) on page 200
 - [":BUS<n>:BITS"](#) on page 201
 - [":BUS<n>:CLEar"](#) on page 203
 - [":BUS<n>:DISPlay"](#) on page 204
 - [":BUS<n>:MASK"](#) on page 206
 - [":CHANnel<n>:LABel"](#) on page 225
 - [":DISPlay:LABList"](#) on page 250
 - [":DIGital<n>:LABel"](#) on page 240

Example Code

```
' Set the bus 1 label to "Data":
myScope.WriteString ":BUS1:LABel 'Data'
```

:BUS<n>:MASK

N (see [page 786](#))

Command Syntax :BUS<n>:MASK <mask>

<mask> ::= 32-bit integer in decimal, <nondecimal>, or <string>

<nondecimal> ::= #Hnn...n where n ::= {0,...,9 | A,...,F} for hexadecimal

<nondecimal> ::= #Bnn...n where n ::= {0 | 1} for binary

<string> ::= "0xnn...n" where n ::= {0,...,9 | A,...,F} for hexadecimal

<n> ::= An integer, 1 or 2, is attached as a suffix to BUS and defines the bus that is affected by the command.

The :BUS<n>:MASK command defines the bits included and excluded in the selected bus according to the mask. Set a mask bit to a "1" to include that bit in the selected bus, and set a mask bit to a "0" to exclude it.

NOTE

This command is only valid for the MSO models.

Query Syntax :BUS<n>:MASK?

The :BUS<n>:MASK? query returns the mask value for the specified bus.

Return Format <mask><NL> in decimal format

- See Also**
- ["Introduction to :BUS<n> Commands"](#) on page 199
 - [":BUS<n>:BIT<m>"](#) on page 200
 - [":BUS<n>:BITS"](#) on page 201
 - [":BUS<n>:CLEar"](#) on page 203
 - [":BUS<n>:DISPlay"](#) on page 204
 - [":BUS<n>:LABel"](#) on page 205

:CALibrate Commands

Utility commands for viewing calibration status and for starting the user calibration procedure. See "[Introduction to :CALibrate Commands](#)" on page 207.

Table 58 :CALibrate Commands Summary

Command	Query	Options and Query Returns
n/a	:CALibrate:DATE? (see page 209)	<return value> ::= <day>,<month>,<year>; all in NR1 format
:CALibrate:LABel <string> (see page 210)	:CALibrate:LABel? (see page 210)	<string> ::= quoted ASCII string up to 32 characters
:CALibrate:OUTPut <signal> (see page 211)	:CALibrate:OUTPut? (see page 211)	<signal> ::= {TRIGgers SOURce DSource MASK}
:CALibrate:START (see page 212)	n/a	n/a
n/a	:CALibrate:STATus? (see page 213)	<return value> ::= ALL,<status_code>,<status_string> <status_code> ::= an integer status code <status_string> ::= an ASCII status string
n/a	:CALibrate:SWITCh? (see page 214)	{PROtected UNPRotected}
n/a	:CALibrate:TEMPeratur e? (see page 215)	<return value> ::= degrees C delta since last cal in NR3 format
n/a	:CALibrate:TIME? (see page 216)	<return value> ::= <hours>,<minutes>,<seconds>; all in NR1 format

Introduction to :CALibrate Commands

The CALibrate subsystem provides utility commands for:

- Determining the state of the calibration factor protection switch (CAL PROTECT).
- Saving and querying the calibration label string.
- Reporting the calibration time and date.
- Reporting changes in the temperature since the last calibration.

5 Commands by Subsystem

- Starting the user calibration procedure.

:CALibrate:DATE

N (see [page 786](#))

Query Syntax :CALibrate:DATE?

The :CALibrate:DATE? query returns the date of the last calibration.

Return Format <date><NL>

<date> ::= day,month,year in NR1 format<NL>

See Also • ["Introduction to :CALibrate Commands"](#) on page 207

:CALibrate:LABel

N (see [page 786](#))

Command Syntax :CALibrate:LABel <string>

<string> ::= quoted ASCII string of up to 32 characters in length, not including the quotes

The CALibrate:LABel command saves a string that is up to 32 characters in length into the instrument's non-volatile memory. The string may be used to record calibration dates or other information as needed.

Query Syntax :CALibrate:LABel?

The :CALibrate:LABel? query returns the contents of the calibration label string.

Return Format <string><NL>

<string> ::= unquoted ASCII string of up to 32 characters in length

See Also • ["Introduction to :CALibrate Commands"](#) on page 207

:CALibrate:OUTPut

N (see [page 786](#))

Command Syntax :CALibrate:OUTPut <signal>
 <signal> ::= {TRIGgers | SOURce | DSOurce | MASK}

The CALibrate:OUTPut command sets the signal that is available on the rear panel TRIG OUT BNC:

- TRIGgers – pulse when a trigger event occurs.
- SOURce – raw output of trigger comparator.
- DSOurce – SOURce frequency divided by 8.
- MASK – signal from mask test indicating a success or fail mask test.

Query Syntax :CALibrate:OUTPut?

The :CALibrate:OUTPut query returns the current source of the TRIG OUT BNC signal.

Return Format <signal><NL>
 <signal> ::= {TRIG | SOUR | DSO | MASK}

- See Also**
- ["Introduction to :CALibrate Commands"](#) on page 207
 - [":MTEST:OUTPut"](#) on page 376

:CALibrate:START

N (see [page 786](#))

Command Syntax :CALibrate:START

The CALibrate:START command starts the user calibration procedure.

NOTE

Before starting the user calibration procedure, you must set the rear panel CALIBRATION switch to UNPROTECTED, and you must connect BNC cables from the TRIG OUT connector to the analog channel inputs. See the *User's Guide* for details.

-
- See Also**
- "[Introduction to :CALibrate Commands](#)" on page 207
 - "[:CALibrate:SWITCh](#)" on page 214

:CALibrate:STATus

N (see [page 786](#))

Query Syntax :CALibrate:STATus?

The :CALibrate:STATus? query returns the summary results of the last user calibration procedure.

Return Format <return value><NL>

<return value> ::= ALL,<status_code>,<status_string>

<status_code> ::= an integer status code

<status_string> ::= an ASCII status string

See Also • ["Introduction to :CALibrate Commands"](#) on page 207

:CALibrate:SWITCh

N (see [page 786](#))

Query Syntax :CALibrate:SWITCh?

The :CALibrate:SWITCh? query returns the rear-panel calibration protect (CAL PROTECT) switch state. The value PROTECTED indicates calibration is disabled, and UNPROTECTED indicates calibration is enabled.

Return Format <switch><NL>
<switch> ::= {PROT | UNPR}

See Also • ["Introduction to :CALibrate Commands"](#) on page 207

:CALibrate:TEMPerature

N (see [page 786](#))

Query Syntax :CALibrate:TEMPerature?

The :CALibrate:TEMPerature? query returns the change in temperature since the last user calibration procedure.

Return Format <return value><NL>

<return value> ::= degrees C delta since last cal in NR3 format

See Also • ["Introduction to :CALibrate Commands"](#) on page 207

:CALibrate:TIME

N (see [page 786](#))

Query Syntax :CALibrate:TIME?

The :CALibrate:TIME? query returns the time of the last calibration.

Return Format <date><NL>

<date> ::= hour,minutes,seconds in NR1 format

See Also • ["Introduction to :CALibrate Commands"](#) on page 207

:CHANnel<n> Commands

Control all oscilloscope functions associated with individual analog channels or groups of channels. See ["Introduction to :CHANnel<n> Commands"](#) on page 218.

Table 59 :CHANnel<n> Commands Summary

Command	Query	Options and Query Returns
:CHANnel<n>:BWLimit {0 OFF} {1 ON}} (see page 220)	:CHANnel<n>:BWLimit? (see page 220)	{0 1} <n> ::= 1-2 or 1-4 in NR1 format
:CHANnel<n>:COUpling <coupling> (see page 221)	:CHANnel<n>:COUpling? (see page 221)	<coupling> ::= {AC DC} <n> ::= 1-2 or 1-4 in NR1 format
:CHANnel<n>:DISPlay {0 OFF} {1 ON}} (see page 222)	:CHANnel<n>:DISPlay? (see page 222)	{0 1} <n> ::= 1-2 or 1-4 in NR1 format
:CHANnel<n>:IMPedance <impedance> (see page 223)	:CHANnel<n>:IMPedance ? (see page 223)	<impedance> ::= {ONEMeg FIFTy} <n> ::= 1-2 or 1-4 in NR1 format
:CHANnel<n>:INVert {0 OFF} {1 ON}} (see page 224)	:CHANnel<n>:INVert? (see page 224)	{0 1} <n> ::= 1-2 or 1-4 in NR1 format
:CHANnel<n>:LABel <string> (see page 225)	:CHANnel<n>:LABel? (see page 225)	<string> ::= any series of 10 or less ASCII characters enclosed in quotation marks <n> ::= 1-2 or 1-4 in NR1 format
:CHANnel<n>:OFFSet <offset>[suffix] (see page 226)	:CHANnel<n>:OFFSet? (see page 226)	<offset> ::= Vertical offset value in NR3 format [suffix] ::= {V mV} <n> ::= 1-2 or 1-4; in NR1 format
:CHANnel<n>:PROBe <attenuation> (see page 227)	:CHANnel<n>:PROBe? (see page 227)	<attenuation> ::= Probe attenuation ratio in NR3 format <n> ::= 1-2 or 1-4r in NR1 format
:CHANnel<n>:PROBe:HEAD[:TYPE] <head_param> (see page 228)	:CHANnel<n>:PROBe:HEAD[:TYPE]? (see page 228)	<head_param> ::= {SEND0 SEND6 SEND12 SEND20 DIFF0 DIFF6 DIFF12 DIFF20 NONE} <n> ::= 1-2 or 1-4 in NR1 format
n/a	:CHANnel<n>:PROBe:ID? (see page 229)	<probe id> ::= unquoted ASCII string up to 11 characters <n> ::= 1-2 or 1-4 in NR1 format

Table 59 :CHANnel<n> Commands Summary (continued)

Command	Query	Options and Query Returns
:CHANnel<n>:PROBe:SKEW <skew_value> (see page 230)	:CHANnel<n>:PROBE:SKEW? (see page 230)	<skew_value> ::= -100 ns to +100 ns in NR3 format <n> ::= 1-2 or 1-4 in NR1 format
:CHANnel<n>:PROBe:STYPe <signal type> (see page 231)	:CHANnel<n>:PROBE:STYPe? (see page 231)	<signal type> ::= {DIFFerential SINGLE} <n> ::= 1-2 or 1-4 in NR1 format
:CHANnel<n>:PROTection (see page 232)	:CHANnel<n>:PROTECTioN? (see page 232)	{NORM TRIP} <n> ::= 1-2 or 1-4 in NR1 format
:CHANnel<n>:RANGe <range>[suffix] (see page 233)	:CHANnel<n>:RANGE? (see page 233)	<range> ::= Vertical full-scale range value in NR3 format [suffix] ::= {V mV} <n> ::= 1-2 or 1-4 in NR1 format
:CHANnel<n>:SCALE <scale>[suffix] (see page 234)	:CHANnel<n>:SCALE? (see page 234)	<scale> ::= Vertical units per division value in NR3 format [suffix] ::= {V mV} <n> ::= 1-2 or 1-4 in NR1 format
:CHANnel<n>:UNITs <units> (see page 235)	:CHANnel<n>:UNITs? (see page 235)	<units> ::= {VOLT AMPere} <n> ::= 1-2 or 1-4 in NR1 format
:CHANnel<n>:VERNier {{0 OFF} {1 ON}} (see page 236)	:CHANnel<n>:VERNier? (see page 236)	{0 1} <n> ::= 1-2 or 1-4 in NR1 format

Introduction to :CHANnel<n> Commands

<n> ::= {1 | 2 | 3 | 4} for the four channel oscilloscope models
<n> ::= {1 | 2} for the two channel oscilloscope models

The CHANnel<n> subsystem commands control an analog channel (vertical or Y-axis of the oscilloscope). Channels are independently programmable for all offset, probe, coupling, bandwidth limit, inversion, vernier, and range (scale) functions. The channel number (1, 2, 3, or 4) specified in the command selects the analog channel that is affected by the command.

A label command provides identifying annotations of up to 10 characters.

You can toggle the channel displays on and off with the :CHANnel<n>:DISPlay command as well as with the root level commands :VIEW and :BLANK.

NOTE

The obsolete CHANnel subsystem is supported.

Reporting the Setup

Use :CHANnel1?, :CHANnel2?, :CHANnel3? or :CHANnel4? to query setup information for the CHANnel<n> subsystem.

Return Format

The following are sample responses from the :CHANnel<n>? query. In this case, the query was issued following a *RST command.

```
:CHAN1:RANG +40.0E+00;OFFS +0.00000E+00;COUP DC;IMP ONEM;DISP 1;BWL 0;  
INV 0;LAB "1";UNIT VOLT;PROB +10E+00;PROB:SKEW +0.00E+00;STYP SING
```

:CHANnel<n>:BWLimit

C (see [page 786](#))

Command Syntax :CHANnel<n>:BWLimit <bwlimit>

<bwlimit> ::= {{1 | ON} | {0 | OFF}}

<n> ::= {1 | 2 | 3 | 4} for the four channel oscilloscope models

<n> ::= {1 | 2} for the two channel oscilloscope models

The :CHANnel<n>:BWLimit command controls an internal low-pass filter. When the filter is on, the bandwidth of the specified channel is limited to approximately 25 MHz.

Query Syntax :CHANnel<n>:BWLimit?

The :CHANnel<n>:BWLimit? query returns the current setting of the low-pass filter.

Return Format <bwlimit><NL>

<bwlimit> ::= {1 | 0}

See Also • ["Introduction to :CHANnel<n> Commands"](#) on page 218

:CHANnel<n>:COUPling

C (see [page 786](#))

Command Syntax :CHANnel<n>:COUPling <coupling>

<coupling> ::= {AC | DC}

<n> ::= {1 | 2 | 3 | 4} for the four channel oscilloscope models

<n> ::= {1 | 2} for the two channel oscilloscope models

The :CHANnel<n>:COUPling command selects the input coupling for the specified channel. The coupling for each analog channel can be set to AC or DC.

Query Syntax :CHANnel<n>:COUPling?

The :CHANnel<n>:COUPling? query returns the current coupling for the specified channel.

Return Format <coupling value><NL>

<coupling value> ::= {AC | DC}

See Also • ["Introduction to :CHANnel<n> Commands"](#) on page 218

:CHANnel<n>:DISPlay

C (see [page 786](#))

Command Syntax :CHANnel<n>:DISPlay <display value>
<display value> ::= {{1 | ON} | {0 | OFF}}
<n> ::= {1 | 2 | 3 | 4} for the four channel oscilloscope models
<n> ::= {1 | 2} for the two channel oscilloscope models

The :CHANnel<n>:DISPlay command turns the display of the specified channel on or off.

Query Syntax :CHANnel<n>:DISPlay?

The :CHANnel<n>:DISPlay? query returns the current display setting for the specified channel.

Return Format <display value><NL>
<display value> ::= {1 | 0}

- See Also**
- ["Introduction to :CHANnel<n> Commands"](#) on page 218
 - [":VIEW"](#) on page 180
 - [":BLANK"](#) on page 148
 - [":STATus"](#) on page 177
 - [":POD<n>:DISPlay"](#) on page 393
 - [":DIGital<n>:DISPlay"](#) on page 239

:CHANnel<n>:IMPedance

C (see [page 786](#))

Command Syntax :CHANnel<n>:IMPedance <impedance>

<impedance> ::= {ONEMeg | FIFTy}

<n> ::= {1 | 2 | 3 | 4} for the four channel oscilloscope models

<n> ::= {1 | 2} for the two channel oscilloscope models

The :CHANnel<n>:IMPedance command selects the input impedance setting for the specified analog channel. The legal values for this command are ONEMeg (1 M Ω) and FIFTy (50 Ω).

NOTE

The analog channel input impedance of the 100 MHz bandwidth oscilloscope models is fixed at ONEMeg (1 M Ω).

Query Syntax :CHANnel<n>:IMPedance?

The :CHANnel<n>:IMPedance? query returns the current input impedance setting for the specified channel.

Return Format <impedance value><NL>

<impedance value> ::= {ONEM | FIFT}

See Also • ["Introduction to :CHANnel<n> Commands"](#) on page 218

:CHANnel<n>:INVert

N (see [page 786](#))

Command Syntax :CHANnel<n>:INVert <invert value>

<invert value> ::= {{1 | ON} | {0 | OFF}}

<n> ::= {1 | 2 | 3 | 4} for the four channel oscilloscope models

<n> ::= {1 | 2} for the two channel oscilloscope models

The :CHANnel<n>:INVert command selects whether or not to invert the input signal for the specified channel. The inversion may be 1 (ON/inverted) or 0 (OFF/not inverted).

Query Syntax :CHANnel<n>:INVert?

The :CHANnel<n>:INVert? query returns the current state of the channel inversion.

Return Format <invert value><NL>

<invert value> ::= {0 | 1}

See Also • ["Introduction to :CHANnel<n> Commands"](#) on page 218

:CHANnel<n>:LABel

N (see [page 786](#))

Command Syntax :CHANnel<n>:LABel <string>
 <string> ::= quoted ASCII string
 <n> ::= {1 | 2 | 3 | 4} for the four channel oscilloscope models
 <n> ::= {1 | 2} for the two channel oscilloscope models

NOTE

Label strings are 10 characters or less, and may contain any commonly used ASCII characters. Labels with more than 10 characters are truncated to 10 characters. Lower case characters are converted to upper case.

The :CHANnel<n>:LABel command sets the analog channel label to the string that follows. Setting a label for a channel also adds the name to the label list in non-volatile memory (replacing the oldest label in the list).

Query Syntax :CHANnel<n>:LABel?

The :CHANnel<n>:LABel? query returns the label associated with a particular analog channel.

Return Format <string><NL>
 <string> ::= quoted ASCII string

- See Also**
- ["Introduction to :CHANnel<n> Commands"](#) on page 218
 - [":DISPlay:LABel"](#) on page 249
 - [":DIGital<n>:LABel"](#) on page 240
 - [":DISPlay:LABList"](#) on page 250
 - [":BUS<n>:LABel"](#) on page 205

Example Code

```
' LABEL - This command allows you to write a name (10 characters
' maximum) next to the channel number. It is not necessary, but
' can be useful for organizing the display.
myScope.WriteString ":CHANNEL1:LABEL " "CAL 1" " " ' Label ch1 "CAL 1".
myScope.WriteString ":CHANNEL2:LABEL " "CAL2" " " ' Label ch1 "CAL2".
```

Example program from the start: ["VISA COM Example in Visual Basic"](#) on page 812

:CHANnel<n>:OFFSet

C (see [page 786](#))

Command Syntax :CHANnel<n>:OFFSet <offset> [<suffix>]

<offset> ::= Vertical offset value in NR3 format

<suffix> ::= {V | mV}

<n> ::= {1 | 2 | 3 | 4} for the four channel oscilloscope models

<n> ::= {1 | 2} for the two channel oscilloscope models

The :CHANnel<n>:OFFSet command sets the value that is represented at center screen for the selected channel. The range of legal values varies with the value set by the :CHANnel<n>:RANGe and :CHANnel<n>:SCALE commands. If you set the offset to a value outside of the legal range, the offset value is automatically set to the nearest legal value. Legal values are affected by the probe attenuation setting.

Query Syntax :CHANnel<n>:OFFSet?

The :CHANnel<n>:OFFSet? query returns the current offset value for the selected channel.

Return Format <offset><NL>

<offset> ::= Vertical offset value in NR3 format

- See Also**
- "[Introduction to :CHANnel<n> Commands](#)" on page 218
 - "[:CHANnel<n>:RANGe](#)" on page 233
 - "[:CHANnel<n>:SCALE](#)" on page 234
 - "[:CHANnel<n>:PROBe](#)" on page 227

:CHANnel<n>:PROBe

C (see [page 786](#))

Command Syntax :CHANnel<n>:PROBe <attenuation>

<attenuation> ::= probe attenuation ratio in NR3 format

<n> ::= {1 | 2 | 3 | 4} for the four channel oscilloscope models

<n> ::= {1 | 2} for the two channel oscilloscope models

The obsolete attenuation values X1, X10, X20, X100 are also supported.

The :CHANnel<n>:PROBe command specifies the probe attenuation factor for the selected channel. The probe attenuation factor may be 0.1 to 1000. This command does not change the actual input sensitivity of the oscilloscope. It changes the reference constants for scaling the display factors, for making automatic measurements, and for setting trigger levels.

If an AutoProbe probe is connected to the oscilloscope, the attenuation value cannot be changed from the sensed value. Attempting to set the oscilloscope to an attenuation value other than the sensed value produces an error.

Query Syntax :CHANnel<n>:PROBe?

The :CHANnel<n>:PROBe? query returns the current probe attenuation factor for the selected channel.

Return Format <attenuation><NL>

<attenuation> ::= probe attenuation ratio in NR3 format

- See Also**
- ["Introduction to :CHANnel<n> Commands"](#) on page 218
 - [":CHANnel<n>:RANGe"](#) on page 233
 - [":CHANnel<n>:SCALE"](#) on page 234
 - [":CHANnel<n>:OFFSet"](#) on page 226

Example Code

```
' CHANNEL_PROBE - Sets the probe attenuation factor for the selected
' channel. The probe attenuation factor may be set from 0.1 to 1000.
myScope.WriteString ":CHAN1:PROBE 10" ' Set Probe to 10:1.
```

Example program from the start: ["VISA COM Example in Visual Basic"](#) on page 812

:CHANnel<n>:PROBe:HEAD[:TYPE]

C (see page 786)

Command Syntax**NOTE**

This command is valid only for the 113xA Series probes.

```
:CHANnel<n>:PROBe:HEAD[:TYPE] <head_param>
<head_param> ::= {SEND0 | SEND6 | SEND12 | SEND20 | DIFF0 | DIFF6
                  | DIFF12 | DIFF20 | NONE}
<n> ::= {1 | 2 | 3 | 4}
```

The :CHANnel<n>:PROBe:HEAD[:TYPE] command sets an analog channel probe head type and dB value. You can choose from:

- SEND0 – Single-ended, 0dB.
- SEND6 – Single-ended, 6dB.
- SEND12 – Single-ended, 12dB.
- SEND20 – Single-ended, 20dB.
- DIFF0 – Differential, 0dB.
- DIFF6 – Differential, 6dB.
- DIFF12 – Differential, 12dB.
- DIFF20 – Differential, 20dB.

Query Syntax :CHANnel<n>:PROBe:HEAD[:TYPE]?

The :CHANnel<n>:PROBe:HEAD[:TYPE]? query returns the current probe head type setting for the selected channel.

Return Format <head_param><NL>

```
<head_param> ::= {SEND0 | SEND6 | SEND12 | SEND20 | DIFF0 | DIFF6
                  | DIFF12 | DIFF20 | NONE}
```

- See Also**
- "Introduction to :CHANnel<n> Commands" on page 218
 - ":CHANnel<n>:PROBe" on page 227
 - ":CHANnel<n>:PROBe:ID" on page 229
 - ":CHANnel<n>:PROBe:SKEW" on page 230
 - ":CHANnel<n>:PROBe:STYPe" on page 231

:CHANnel<n>:PROBe:ID

C (see [page 786](#))

Query Syntax :CHANnel<n>:PROBe:ID?

<n> ::= {1 | 2 | 3 | 4} for the four channel oscilloscope models

<n> ::= {1 | 2} for the two channel oscilloscope models

The :CHANnel<n>:PROBe:ID? query returns the type of probe attached to the specified oscilloscope channel.

Return Format <probe id><NL>

<probe id> ::= unquoted ASCII string up to 11 characters

Some of the possible returned values are:

- 1131A
- 1132A
- 1134A
- 1147A
- 1153A
- 1154A
- 1156A
- 1157A
- 1158A
- 1159A
- AutoProbe
- E2621A
- E2622A
- E2695A
- E2697A
- HP1152A
- HP1153A
- NONE
- Probe
- Unknown
- Unsupported

See Also • ["Introduction to :CHANnel<n> Commands"](#) on page 218

:CHANnel<n>:PROBe:SKEW

C (see [page 786](#))

Command Syntax :CHANnel<n>:PROBe:SKEW <skew value>
<skew value> ::= skew time in NR3 format
<skew value> ::= -100 ns to +100 ns
<n> ::= {1 | 2 | 3 | 4}

The :CHANnel<n>:PROBe:SKEW command sets the channel-to-channel skew factor for the specified channel. Each analog channel can be adjusted + or -100 ns for a total of 200 ns difference between channels. You can use the oscilloscope's probe skew control to remove cable-delay errors between channels.

Query Syntax :CHANnel<n>:PROBe:SKEW?

The :CHANnel<n>:PROBe:SKEW? query returns the current probe skew setting for the selected channel.

Return Format <skew value><NL>
<skew value> ::= skew value in NR3 format

See Also • ["Introduction to :CHANnel<n> Commands"](#) on page 218

:CHANnel<n>:PROBe:STYPe

C (see [page 786](#))

Command Syntax**NOTE**

This command is valid only for the 113xA Series probes.

```
:CHANnel<n>:PROBe:STYPe <signal type>
<signal type> ::= {DIFFerential | SINGLE}
<n> ::= {1 | 2 | 3 | 4} for the four channel oscilloscope models
<n> ::= {1 | 2} for the two channel oscilloscope models
```

The :CHANnel<n>:PROBe:STYPe command sets the channel probe signal type (STYPe) to differential or single-ended when using the 113xA Series probes and determines how offset is applied.

When single-ended is selected, the :CHANnel<n>:OFFset command changes the offset value of the probe amplifier. When differential is selected, the :CHANnel<n>:OFFset command changes the offset value of the channel amplifier.

Query Syntax :CHANnel<n>:PROBe:STYPe?

The :CHANnel<n>:PROBe:STYPe? query returns the current probe signal type setting for the selected channel.

Return Format <signal type><NL>

```
<signal type> ::= {DIFF | SING}
```

- See Also**
- "[Introduction to :CHANnel<n> Commands](#)" on page 218
 - "[:CHANnel<n>:OFFSet](#)" on page 226

:CHANnel<n>:PROTection

N (see [page 786](#))

Command Syntax :CHANnel<n>:PROTection[:CLEar]

<n> ::= {1 | 2 | 3 | 4}

When the analog channel input impedance is set to 50Ω (on the 300 MHz, 500 MHz, and 1 GHz bandwidth oscilloscope models), the input channels are protected against overvoltage. When an overvoltage condition is sensed, the input impedance for the channel is automatically changed to 1 MΩ. The :CHANnel<n>:PROTection[:CLEar] command is used to clear (reset) the overload protection. It allows the channel to be used again in 50Ω mode after the signal that caused the overload has been removed from the channel input. Reset the analog channel input impedance to 50Ω (see [":CHANnel<n>:IMPedance"](#) on page 223) after clearing the overvoltage protection.

Query Syntax :CHANnel<n>:PROTection?

The :CHANnel<n>:PROTection query returns the state of the input protection for CHANnel<n>. If a channel input has experienced an overload, TRIP (tripped) will be returned; otherwise NORM (normal) is returned.

Return Format {NORM | TRIP}<NL>

- See Also**
- ["Introduction to :CHANnel<n> Commands"](#) on page 218
 - [":CHANnel<n>:COUPLing"](#) on page 221
 - [":CHANnel<n>:IMPedance"](#) on page 223
 - [":CHANnel<n>:PROBe"](#) on page 227

:CHANnel<n>:RANGe

C (see [page 786](#))

Command Syntax :CHANnel<n>:RANGe <range>[<suffix>]
 <range> ::= vertical full-scale range value in NR3 format
 <suffix> ::= {V | mV}
 <n> ::= {1 | 2 | 3 | 4} for the four channel oscilloscope models
 <n> ::= {1 | 2} for the two channel oscilloscope models

The :CHANnel<n>:RANGe command defines the full-scale vertical axis of the selected channel. When using 1:1 probe attenuation, legal values for the range are shown in the following table.

Table 60 Vertical Range Values with 1:1 Probe Attenuation

Models	Input Impedance	
	1 MΩ	50 Ω
DSO/MS0701xA/B	16 mV to 40 V	16 mV to 40 V
DSO/MS0703xA/B	16 mV to 40 V	16 mV to 40 V
DSO/MS0705xA/B	16 mV to 40 V	16 mV to 40 V
DSO/MS07104A/B	16 mV to 40 V	16 mV to 8 V

If the probe attenuation is changed, the range value is multiplied by the probe attenuation factor.

Query Syntax :CHANnel<n>:RANGe?

The :CHANnel<n>:RANGe? query returns the current full-scale range setting for the specified channel.

Return Format <range_argument><NL>
 <range_argument> ::= vertical full-scale range value in NR3 format

- See Also**
- ["Introduction to :CHANnel<n> Commands"](#) on page 218
 - [":CHANnel<n>:SCALE"](#) on page 234
 - [":CHANnel<n>:PROBe"](#) on page 227

Example Code

```
' CHANNEL_RANGE - Sets the full scale vertical range in volts. The
' range value is 8 times the volts per division.
myScope.WriteString ":CHANNEL1:RANGE 8" ' Set the vertical range to
8 volts.
```

Example program from the start: ["VISA COM Example in Visual Basic"](#) on page 812

:CHANnel<n>:SCALE

N (see [page 786](#))

Command Syntax :CHANnel<n>:SCALE <scale>[<suffix>]

<scale> ::= vertical units per division in NR3 format

<suffix> ::= {V | mV}

<n> ::= {1 | 2 | 3 | 4} for the four channel oscilloscope models

<n> ::= {1 | 2} for the two channel oscilloscope models

The :CHANnel<n>:SCALE command sets the vertical scale, or units per division, of the selected channel. When using 1:1 probe attenuation, legal values for the scale are shown in the following table.

Table 61 Vertical Scale Values with 1:1 Probe Attenuation

Models	Input Impedance	
	1 M Ω	50 Ω
DSO/MS0701xA/B	2 mV to 5 V	2 mV to 5 V
DSO/MS0703xA/B	2 mV to 5 V	2 mV to 5 V
DSO/MS0705xA/B	2 mV to 5 V	2 mV to 5 V
DSO/MS07104A/B	2 mV to 5 V	2 mV to 1 V

If the probe attenuation is changed, the scale value is multiplied by the probe's attenuation factor.

Query Syntax :CHANnel<n>:SCALE?

The :CHANnel<n>:SCALE? query returns the current scale setting for the specified channel.

Return Format <scale value><NL>

<scale value> ::= vertical units per division in NR3 format

- See Also**
- ["Introduction to :CHANnel<n> Commands"](#) on page 218
 - [":CHANnel<n>:RANGe"](#) on page 233
 - [":CHANnel<n>:PROBe"](#) on page 227

:CHANnel<n>:UNITs

N (see [page 786](#))

Command Syntax :CHANnel<n>:UNITs <units>

<units> ::= {VOLT | AMPere}

<n> ::= {1 | 2} for the two channel oscilloscope models

<n> ::= {1 | 2 | 3 | 4} for the four channel oscilloscope models

The :CHANnel<n>:UNITs command sets the measurement units for the connected probe. Select VOLT for a voltage probe and select AMPere for a current probe. Measurement results, channel sensitivity, and trigger level will reflect the measurement units you select.

Query Syntax :CHANnel<n>:UNITs?

The :CHANnel<n>:UNITs? query returns the current units setting for the specified channel.

Return Format <units><NL>

<units> ::= {VOLT | AMP}

- See Also**
- ["Introduction to :CHANnel<n> Commands"](#) on page 218
 - [":CHANnel<n>:RANGe"](#) on page 233
 - [":CHANnel<n>:PROBe"](#) on page 227
 - [":EXTernal:UNITs"](#) on page 263

:CHANnel<n>:VERNier

N (see [page 786](#))

Command Syntax :CHANnel<n>:VERNier <vernier value>

<vernier value> ::= {{1 | ON} | {0 | OFF}}

<n> ::= {1 | 2 | 3 | 4} for the four channel oscilloscope models

<n> ::= {1 | 2} for the two channel oscilloscope models

The :CHANnel<n>:VERNier command specifies whether the channel's vernier (fine vertical adjustment) setting is ON (1) or OFF (0).

Query Syntax :CHANnel<n>:VERNier?

The :CHANnel<n>:VERNier? query returns the current state of the channel's vernier setting.

Return Format <vernier value><NL>

<vernier value> ::= {0 | 1}

See Also • ["Introduction to :CHANnel<n> Commands"](#) on page 218

:DIGital<n> Commands

Control all oscilloscope functions associated with individual digital channels. See "[Introduction to :DIGital<n> Commands](#)" on page 237.

Table 62 :DIGital<n> Commands Summary

Command	Query	Options and Query Returns
:DIGital<n>:DISPlay {0 OFF} {1 ON} (see page 239)	:DIGital<n>:DISPlay? (see page 239)	{0 1} <n> ::= 0-15; an integer in NR1 format
:DIGital<n>:LABel <string> (see page 240)	:DIGital<n>:LABel? (see page 240)	<string> ::= any series of 10 or less ASCII characters enclosed in quotation marks <n> ::= 0-15; an integer in NR1 format
:DIGital<n>:POSition <position> (see page 241)	:DIGital<n>:POSition? (see page 241)	<n> ::= 0-15; an integer in NR1 format <position> ::= 0-7 if display size = large, 0-15 if size = medium, 0-31 if size = small
:DIGital<n>:SIZE <value> (see page 242)	:DIGital<n>:SIZE? (see page 242)	<value> ::= {SMALl MEDium LARGe}
:DIGital<n>:THReshold <value>[suffix] (see page 243)	:DIGital<n>:THReshold? (see page 243)	<n> ::= 0-15; an integer in NR1 format <value> ::= {CMOS ECL TTL <user defined value>} <user defined value> ::= value in NR3 format from -8.00 to +8.00 [suffix] ::= {V mV uV}

Introduction to :DIGital<n> Commands <n> ::= {0,...,15}

The DIGital subsystem commands control the viewing, labeling, and positioning of digital channels. They also control threshold settings for groups of digital channels (D0-D7, D8-D15).

NOTE

These commands are only valid for the MSO models.

Reporting the Setup

Use :DIGital<n>? to query setup information for the DIGital subsystem.

5 Commands by Subsystem

Return Format

The following is a sample response from the :DIGital0? query. In this case, the query was issued following a *RST command.

```
:DIG0:DISP 0;THR +1.40E+00;LAB 'D0';POS +0
```

:DIGital<n>:DISPlay

N (see [page 786](#))

Command Syntax :DIGital<n>:DISPlay <display>

<display> ::= {{1 | ON} | {0 | OFF}}

<n> ::= An integer, 0, 1, ..., 15, is attached as a suffix to the command and defines the logic channel that is affected by the command.

The :DIGital<n>:DISPlay command turns digital display on or off for the specified channel.

NOTE

This command is only valid for the MSO models.

Query Syntax :DIGital<n>:DISPlay?

The :DIGital<n>:DISPlay? query returns the current digital display setting for the specified channel.

Return Format <display><NL>

<display> ::= {0 | 1}

- See Also**
- ["Introduction to :DIGital<n> Commands"](#) on page 237
 - [":POD<n>:DISPlay"](#) on page 393
 - [":CHANnel<n>:DISPlay"](#) on page 222
 - [":VIEW"](#) on page 180
 - [":BLANK"](#) on page 148
 - [":STATus"](#) on page 177

:DIGital<n>:LABel

N (see [page 786](#))

Command Syntax :DIGital<n>:LABel <string>

<string> ::= any series of 10 or less characters as quoted ASCII string.

<n> ::= An integer, 0,...,15, is attached as a suffix to the command and defines the logic channel that is affected by the command.

The :DIGital<n>:LABel command sets the channel label to the string that follows. Setting a label for a channel also adds the name to the label list in non-volatile memory (replacing the oldest label in the list).

NOTE

This command is only valid for the MSO models.

NOTE

Label strings are 10 characters or less, and may contain any commonly used ASCII characters. Labels with more than 10 characters are truncated to 10 characters.

Query Syntax :DIGital<n>:LABel?

The :DIGital<n>:LABel? query returns the name of the specified channel.

Return Format <label string><NL>

<label string> ::= any series of 10 or less characters as a quoted ASCII string.

- See Also**
- ["Introduction to :DIGital<n> Commands"](#) on page 237
 - [":CHANnel<n>:LABel"](#) on page 225
 - [":DISPlay:LABList"](#) on page 250
 - [":BUS<n>:LABel"](#) on page 205

:DIGital<n>:POSition

N (see [page 786](#))

Command Syntax :DIGital<n>:POSition <position>

<position> ::= integer in NR1 format.

<n> ::= An integer, 0, 1,...,15, is attached as a suffix to the command and defines the logic channel that is affected by the command.

Channel Size	Position	Top	Bottom
Large	0-7	7	0
Medium	0-15	15	0
Small	0-31	31	0

The :DIGital<n>:POSition command sets the position of the specified channel.

NOTE

This command is only valid for the MSO models.

Query Syntax :DIGital<n>:POSition?

The :DIGital<n>:POSition? query returns the position of the specified channel.

Return Format <position><NL>

<position> ::= integer in NR1 format.

See Also • ["Introduction to :DIGital<n> Commands"](#) on page 237

:DIGital<n>:SIZE

N (see [page 786](#))

Command Syntax :DIGital<n>:SIZE <value>

<n> ::= An integer, 0, 1, ..., 15, is attached as a suffix to the command and defines the logic channel that is affected by the command.

<value> ::= {SMALl | MEDium | LARGe}

The :DIGital<n>:SIZE command specifies the size of digital channels on the display. Sizes are set for all digital channels. Therefore, if you set the size on digital channel 0 (for example), the same size is set on channels 1 through 15 as well.

NOTE

This command is only valid for the MSO models.

Query Syntax :DIGital<n>:SIZE?

The :DIGital<n>:SIZE? query returns the size setting for the specified digital channels.

Return Format <size_value><NL>

<size_value> ::= {SMAL | MED | LARG}

- See Also**
- "[Introduction to :DIGital<n> Commands](#)" on page 237
 - "[:POD<n>:SIZE](#)" on page 394
 - "[:DIGital<n>:POSition](#)" on page 241

:DIGital<n>:THReshold

N (see [page 786](#))

Command Syntax :DIGital<n>:THReshold <value>

<value> ::= {CMOS | ECL | TTL | <user defined value>[<suffix>]}

<user defined value> ::= -8.00 to +8.00 in NR3 format

<suffix> ::= {V | mV | uV}

<n> ::= An integer, 0, 1, ..., 15, is attached as a suffix to the command and defines the logic channel that is affected by the command.

- TTL = 1.4V
- CMOS = 2.5V
- ECL = -1.3V

The :DIGital<n>:THReshold command sets the logic threshold value for all channels grouped with the specified channel (D0-D7, D8-D15). The threshold is used for triggering purposes and for displaying the digital data as high (above the threshold) or low (below the threshold).

NOTE

This command is only valid for the MSO models.

Query Syntax :DIGital<n>:THReshold?

The :DIGital<n>:THReshold? query returns the threshold value for the specified channel.

Return Format <value><NL>

<value> ::= threshold value in NR3 format

- See Also**
- "Introduction to :DIGital<n> Commands" on page 237
 - ":POD<n>:THReshold" on page 395
 - ":TRIGger[:EDGE]:LEVel" on page 501

:DISPlay Commands

Control how waveforms, graticule, and text are displayed and written on the screen. See ["Introduction to :DISPlay Commands"](#) on page 244.

Table 63 :DISPlay Commands Summary

Command	Query	Options and Query Returns
:DISPlay:CLear (see page 246)	n/a	n/a
:DISPlay:DATA [<format>][,][<area>] [,][<palette>]<display data> (see page 247)	:DISPlay:DATA? [<format>][,][<area>] [,][<palette>] (see page 247)	<format> ::= {TIFF} (command) <area> ::= {GRATICule} (command) <palette> ::= {MONochrome} (command) <format> ::= {TIFF BMP BMP8bit PNG} (query) <area> ::= {GRATICule SCReen} (query) <palette> ::= {MONochrome GRAYscale COLor} (query) <display data> ::= data in IEEE 488.2 # format
:DISPlay:LABel {{0 OFF} {1 ON}} (see page 249)	:DISPlay:LABel? (see page 249)	{0 1}
:DISPlay:LABList <binary block> (see page 250)	:DISPlay:LABList? (see page 250)	<binary block> ::= an ordered list of up to 75 labels, each 10 characters maximum, separated by newline characters
:DISPlay:PERsistence <value> (see page 251)	:DISPlay:PERsistence? (see page 251)	<value> ::= {MINimum INFinite}}
:DISPlay:SOURce <value> (see page 252)	:DISPlay:SOURce? (see page 252)	<value> ::= {PMEMory{0 1 2 3 4 5 6 7 8 9}}
:DISPlay:VECTors {{1 ON} {0 OFF}} (see page 253)	:DISPlay:VECTors? (see page 253)	{1 0}

Introduction to :DISPlay Commands

The DISPlay subsystem is used to control the display storage and retrieval of waveform data, labels, and text. This subsystem allows the following actions:

- Clear the waveform area on the display.
- Turn vectors on or off.

- Set waveform persistence.
- Specify labels.
- Save and Recall display data.

Reporting the Setup

Use :DISPlay? to query the setup information for the DISPlay subsystem.

Return Format

The following is a sample response from the :DISPlay? query. In this case, the query was issued following a *RST command.

```
:DISP:LAB 0;CONN 1;PERS MIN;SOUR PMEM9
```

:DISPlay:CLEar

N (see [page 786](#))

Command Syntax :DISPlay:CLEar

The :DISPlay:CLEar command clears the display and resets all associated measurements. If the oscilloscope is stopped, all currently displayed data is erased. If the oscilloscope is running, all of the data for active channels and functions is erased; however, new data is displayed on the next acquisition.

- See Also**
- "[Introduction to :DISPlay Commands](#)" on page 244
 - "[:CDISplay](#)" on page 149

:DISPlay:DATA

N (see [page 786](#))

Command Syntax :DISPlay:DATA [<format>][,][<area>][,][<palette><display data>
 <format> ::= {TIFF}
 <area> ::= {GRATicule}
 <palette> ::= {MONochrome}
 <display data> ::= binary block data in IEEE-488.2 # format.

The :DISPlay:DATA command writes trace memory data (a display bitmap) to the display or to one of the trace memories in the instrument.

If a data format or area is specified, the :DISPlay:DATA command transfers the data directly to the display. If neither the data format nor the area is specified, the command transfers data to the trace memory specified by the :DISPlay:SOURce command. Available trace memories are PMEMory0-9 and these memories correspond to the INTERN_0-9 files in the front panel Save/Recall menu.

Graticule data is a low resolution bitmap of the graticule area in TIFF format. This is the same data saved using the front panel Save/Recall menu or the *SAV (Save) command.

Query Syntax :DISPlay:DATA? [<format>][,][<area>][,][<palette>
 <format> ::= {TIFF | BMP | BMP8bit | PNG}
 <area> ::= {GRATicule | SCReen}
 <palette> ::= {MONochrome | GRAYscale | COLor}

The :DISPlay:DATA? query reads display data from the screen or from one of the trace memories in the instrument. The format for the data transmission is the # format defined in the IEEE 488.2 specification.

If a data format or area is specified, the :DISPlay:DATA query transfers the data directly from the display. If neither the data format nor the area is specified, the query transfers data from the trace memory specified by the :DISPlay:SOURce command.

Screen data is the full display and is high resolution in grayscale or color. The :HARDcopy:INKSaver setting also affects the screen data. It may be read from the instrument in 24-bit bmp, 8-bit bmp, or 24-bit png format. This data cannot be sent back to the instrument.

Graticule data is a low resolution bitmap of the graticule area in TIFF format. You can get this data and send it back to the oscilloscope.

NOTE

If the format is TIFF, the only valid value area parameter is GRATICule, and the only valid palette parameter is MONOchrome.

If the format is something other than TIFF, the only valid area parameter is SCReen, and the only valid values for palette are GRAYscale or COLor.

Return Format <display data><NL>

<display data> ::= binary block data in IEEE-488.2 # format.

- See Also**
- ["Introduction to :DISPlay Commands"](#) on page 244
 - [":DISPlay:SOURce"](#) on page 252
 - [":HARDcopy:INKSaver"](#) on page 287
 - [":MERGe"](#) on page 158
 - [":PRINT"](#) on page 173
 - ["*RCL \(Recall\)"](#) on page 127
 - ["*SAV \(Save\)"](#) on page 131
 - [":VIEW"](#) on page 180

Example Code

```
' IMAGE_TRANSFER - In this example, we will query for the image data
' with ":DISPLAY:DATA?", read the data, and then save it to a file.
Dim byteData() As Byte
myScope.IO.Timeout = 15000
myScope.WriteString ":DISPLAY:DATA? BMP, SCREEN, COLOR"
byteData = myScope.ReadIEEEBlock(BinaryType_UI1)
' Output display data to a file:
strPath = "c:\scope\data\screen.bmp"
' Remove file if it exists.
If Len(Dir(strPath)) Then
    Kill strPath
End If
Close #1 ' If #1 is open, close it.
Open strPath For Binary Access Write Lock Write As #1 ' Open file f
or output.
Put #1, , byteData ' Write data.
Close #1 ' Close file.
myScope.IO.Timeout = 5000
```

Example program from the start: ["VISA COM Example in Visual Basic"](#) on page 812

:DISPlay:LABel

N (see [page 786](#))

Command Syntax :DISPlay:LABel <value>
 <value> ::= {{1 | ON} | {0 | OFF}}

The :DISPlay:LABel command turns the analog and digital channel labels on and off.

Query Syntax :DISPlay:LABel?

The :DISPlay:LABel? query returns the display mode of the analog and digital labels.

Return Format <value><NL>
 <value> ::= {0 | 1}

- See Also**
- ["Introduction to :DISPlay Commands"](#) on page 244
 - [":CHANnel<n>:LABel"](#) on page 225

Example Code

```
' DISP_LABEL (not executed in this example)
' - Turns label names ON or OFF on the analyzer display.
myScope.WriteString ":DISPLAY:LABEL ON" ' Turn on labels.
```

Example program from the start: ["VISA COM Example in Visual Basic"](#) on page 812

:DISPlay:LABList

N (see [page 786](#))

Command Syntax :DISPlay:LABList <binary block data>

<binary block> ::= an ordered list of up to 75 labels, a maximum of 10 characters each, separated by newline characters.

The :DISPlay:LABList command adds labels to the label list. Labels are added in alphabetical order.

NOTE

Labels that begin with the same alphabetic base string followed by decimal digits are considered duplicate labels. Duplicate labels are not added to the label list. For example, if label "A0" is in the list and you try to add a new label called "A123456789", the new label is not added.

Query Syntax :DISPlay:LABList?

The :DISPlay:LABList? query returns the label list.

Return Format <binary block><NL>

<binary block> ::= an ordered list of up to 75 labels, a maximum of 10 characters each, separated by newline characters.

- See Also**
- "[Introduction to :DISPlay Commands](#)" on page 244
 - "[:DISPlay:LABel](#)" on page 249
 - "[:CHANnel<n>:LABel](#)" on page 225
 - "[:DIGital<n>:LABel](#)" on page 240
 - "[:BUS<n>:LABel](#)" on page 205

:DISPlay:PERStence

N (see [page 786](#))

Command Syntax :DISPlay:PERStence <value>
 <value> ::= {MINimum | INFinite}

The :DISPlay:PERStence command specifies the persistence setting. MINimum indicates zero persistence and INFinite indicates infinite persistence. Use the :DISPlay:CLEar or :CDISplay root command to erase points stored by infinite persistence.

Query Syntax :DISPlay:PERStence?

The :DISPlay:PERStence? query returns the specified persistence value.

Return Format <value><NL>
 <value> ::= {MIN | INF}

- See Also**
- "[Introduction to :DISPlay Commands](#)" on page 244
 - "[:DISPlay:CLEar](#)" on page 246
 - "[:CDISplay](#)" on page 149

:DISPlay:SOURce

N (see [page 786](#))

Command Syntax :DISPlay:SOURce <value>

```
<value> ::= {PMEemory0 | PMEemory1 | PMEemory2 | PMEemory3 | PMEemory4  
            | PMEemory5 | PMEemory6 | PMEemory7 | PMEemory8 | PMEemory9}
```

PMEemory0-9 ::= pixel memory 0 through 9

The :DISPlay:SOURce command specifies the default source and destination for the :DISPlay:DATA command and query. PMEemory0-9 correspond to the INTERN_0-9 files found in the front panel Save/Recall menu.

Query Syntax :DISPlay:SOURce?

The :DISPlay:SOURce? query returns the specified SOURCE.

Return Format <value><NL>

```
<value> ::= {PMEM0 | PMEM1 | PMEM2 | PMEM3 | PMEM4 | PMEM5 | PMEM6  
            | PMEM7 | PMEM8 | PMEM9}
```

- See Also**
- ["Introduction to :DISPlay Commands"](#) on page 244
 - [":DISPlay:DATA"](#) on page 247

:DISPlay:VECTors

N (see [page 786](#))

Command Syntax :DISPlay:VECTors <vectors>

<vectors> ::= {{1 | ON} | {0 | OFF}}

The :DISPlay:VECTors command turns vector display on or off. When vectors are turned on, the oscilloscope displays lines connecting sampled data points. When vectors are turned off, only the sampled data is displayed.

Query Syntax :DISPlay:VECTors?

The :DISPlay:VECTors? query returns whether vector display is on or off.

Return Format <vectors><NL>

<vectors> ::= {1 | 0}

See Also • ["Introduction to :DISPlay Commands"](#) on page 244

:EXternal Trigger Commands

Control the input characteristics of the external trigger input. See "[Introduction to :EXternal Trigger Commands](#)" on page 254.

Table 64 :EXternal Trigger Commands Summary

Command	Query	Options and Query Returns
:EXternal:BWLimit <bwlimit> (see page 256)	:EXternal:BWLimit? (see page 256)	<bwlimit> ::= {0 OFF}
:EXternal:IMPedance <value> (see page 257)	:EXternal:IMPedance? (see page 257)	<impedance> ::= {ONEMeg FIFTy}
:EXternal:PROBe <attenuation> (see page 258)	:EXternal:PROBe? (see page 258)	<attenuation> ::= probe attenuation ratio in NR3 format
n/a	:EXternal:PROBe:ID? (see page 259)	<probe id> ::= unquoted ASCII string up to 11 characters
:EXternal:PROBe:STYPe <signal type> (see page 260)	:EXternal:PROBe:STYPe? (see page 260)	<signal type> ::= {DIFFerential SINGle}
:EXternal:PROTection[:CLEar] (see page 261)	:EXternal:PROTection? (see page 261)	{NORM TRIP}
:EXternal:RANGe <range>[<suffix>] (see page 262)	:EXternal:RANGe? (see page 262)	<range> ::= vertical full-scale range value in NR3 format <suffix> ::= {V mV}
:EXternal:UNITs <units> (see page 263)	:EXternal:UNITs? (see page 263)	<units> ::= {VOLT AMPere}

Introduction to :EXternal Trigger Commands

The EXternal trigger subsystem commands control the input characteristics of the external trigger input. The probe factor, impedance, input range, input protection state, units, and bandwidth limit settings may all be queried. Depending on the instrument type, some settings may be changeable.

Reporting the Setup

Use :EXternal? to query setup information for the EXternal subsystem.

Return Format

The following is a sample response from the :EXTernal query. In this case, the query was issued following a *RST command.

```
:EXT:BWL 0;IMP ONEM;RANG +8.0E+00;UNIT VOLT;PROB +1.0E+00;PROB:STYP SING
```

:EXternal:BWLimit

C (see [page 786](#))

Command Syntax :EXternal:BWLimit <bwlimit>
<bwlimit> ::= {0 | OFF}

The :EXternal:BWLimit command is provided for product compatibility. The only legal value is 0 or OFF. Use the :TRIGger:HFReject command to limit bandwidth on the external trigger input.

Query Syntax :EXternal:BWLimit?

The :EXternal:BWLimit? query returns the current setting of the low-pass filter (always 0).

Return Format <bwlimit><NL>
<bwlimit> ::= 0

- See Also**
- ["Introduction to :EXternal Trigger Commands"](#) on page 254
 - ["Introduction to :TRIGger Commands"](#) on page 467
 - [":TRIGger:HFReject"](#) on page 471

:EXternal:IMPedance

C (see [page 786](#))

Command Syntax :EXternal:IMPedance <value>
 <value> ::= {ONEMeg | FIFTy}

The :EXternal:IMPedance command selects the input impedance setting for the external trigger. The legal values for this command are ONEMeg (1 M Ω) and FIFTy (50 Ω).

NOTE

You can set external trigger input impedance to FIFTy (50 Ω) on the 2-channel, 300 MHz, 500 MHz, and 1 GHz bandwidth oscilloscope models.

Query Syntax :EXternal:IMPedance?

The :EXternal:IMPedance? query returns the current input impedance setting for the external trigger.

Return Format <impedance value><NL>
 <impedance value> ::= {ONEM | FIFT}

- See Also**
- ["Introduction to :EXternal Trigger Commands"](#) on page 254
 - ["Introduction to :TRIGger Commands"](#) on page 467
 - [":CHANnel<n>:IMPedance"](#) on page 223

:EXtErnal:PROBe

C (see [page 786](#))

Command Syntax :EXtErnal:PROBe <attenuation>

<attenuation> ::= probe attenuation ratio in NR3 format

The :EXtErnal:PROBe command specifies the probe attenuation factor for the external trigger. The probe attenuation factor may be 0.1 to 1000. This command does not change the actual input sensitivity of the oscilloscope. It changes the reference constants for scaling the display factors and for setting trigger levels.

If an AutoProbe probe is connected to the oscilloscope, the attenuation value cannot be changed from the sensed value. Attempting to set the oscilloscope to an attenuation value other than the sensed value produces an error.

Query Syntax :EXtErnal:PROBe?

The :EXtErnal:PROBe? query returns the current probe attenuation factor for the external trigger.

Return Format <attenuation><NL>

<attenuation> ::= probe attenuation ratio in NR3 format

- See Also**
- ["Introduction to :EXtErnal Trigger Commands"](#) on page 254
 - [":EXtErnal:RANGe"](#) on page 262
 - ["Introduction to :TRIGger Commands"](#) on page 467
 - [":CHANnel<n>:PROBe"](#) on page 227

:EXtErnal:PROBe:ID

C (see [page 786](#))

Query Syntax :EXtErnal:PROBe:ID?

The :EXtErnal:PROBe:ID? query returns the type of probe attached to the external trigger input.

Return Format <probe id><NL>

<probe id> ::= unquoted ASCII string up to 11 characters

Some of the possible returned values are:

- 1131A
- 1132A
- 1134A
- 1147A
- 1153A
- 1154A
- 1156A
- 1157A
- 1158A
- 1159A
- AutoProbe
- E2621A
- E2622A
- E2695A
- E2697A
- HP1152A
- HP1153A
- NONE
- Probe
- Unknown
- Unsupported

See Also • ["Introduction to :EXtErnal Trigger Commands"](#) on page 254

:EXtErnal:PROBe:STYPe

C (see [page 786](#))

Command Syntax

NOTE

This command is valid only for the 113xA Series probes.

```
:EXtErnal:PROBe:STYPe <signal type>  
<signal type> ::= {DIFFerential | SINGle}
```

The :EXtErnal:PROBe:STYPe command sets the external trigger probe signal type (STYPe) to differential or single-ended when using the 113xA Series probes and determines how offset is applied.

Query Syntax :EXtErnal:PROBe:STYPe?

The :EXtErnal:PROBe:STYPe? query returns the current probe signal type setting for the external trigger.

Return Format <signal type><NL>

```
<signal type> ::= {DIFF | SING}
```

See Also • ["Introduction to :EXtErnal Trigger Commands"](#) on page 254

:EXternal:PROtection

N (see [page 786](#))

Command Syntax :EXternal:PROtection[:CLEar]

When the external trigger input impedance is set to 50Ω (on the 2-channel, 300 MHz, 500 MHz, and 1 GHz bandwidth oscilloscope models), the external trigger input is protected against overvoltage. When an overvoltage condition is sensed, the input impedance for the external trigger is automatically changed to 1 MΩ. The :EXternal:PROtection[:CLEar] command is used to clear (reset) the overload protection. It allows the external trigger to be used again in 50Ω mode after the signal that caused the overload has been removed from the external trigger input. Reset the external trigger input impedance to 50Ω (see "[:EXternal:IMPedance](#)" on [page 257](#)) after clearing the overvoltage protection.

Query Syntax :EXternal:PROtection?

The :EXternal:PROtection query returns the state of the input protection for external trigger. If the external trigger input has experienced an overload, TRIP (tripped) will be returned; otherwise NORM (normal) is returned.

Return Format {NORM | TRIP}<NL>

- See Also**
- "[Introduction to :EXternal Trigger Commands](#)" on [page 254](#)
 - "[:EXternal:IMPedance](#)" on [page 257](#)
 - "[:EXternal:PROBE](#)" on [page 258](#)

:EXtErnal:RANGe

C (see [page 786](#))

Command Syntax :EXtErnal:RANGe <range>[<suffix>]
<range> ::= vertical full-scale range value in NR3 format
<suffix> ::= {V | mV}

The :EXtErnal:RANGe command is provided for product compatibility. When using 1:1 probe attenuation:

- In 2-channel models, the range can be set to 1.0 V or 8.0 V.
- In 4-channel models, the range can only be set to 5.0 V.

If the probe attenuation is changed, the range value is multiplied by the probe attenuation factor.

Query Syntax :EXtErnal:RANGe?

The :EXtErnal:RANGe? query returns the current full-scale range setting for the external trigger.

Return Format <range_argument><NL>
<range_argument> ::= external trigger range value in NR3 format

- See Also**
- ["Introduction to :EXtErnal Trigger Commands"](#) on page 254
 - [":EXtErnal:PROBe"](#) on page 258
 - ["Introduction to :TRIGger Commands"](#) on page 467

:EXtErnal:UNITs

N (see [page 786](#))

Command Syntax :EXtErnal:UNITs <units>

<units> ::= {VOLT | AMPere}

The :EXtErnal:UNITs command sets the measurement units for the probe connected to the external trigger input. Select VOLT for a voltage probe and select AMPere for a current probe. Measurement results, channel sensitivity, and trigger level will reflect the measurement units you select.

Query Syntax :EXtErnal:UNITs?

The :CHANnel<n>:UNITs? query returns the current units setting for the external trigger.

Return Format <units><NL>

<units> ::= {VOLT | AMP}

- See Also**
- ["Introduction to :EXtErnal Trigger Commands"](#) on page 254
 - ["Introduction to :TRIGger Commands"](#) on page 467
 - [":EXtErnal:RANGe"](#) on page 262
 - [":EXtErnal:PROBe"](#) on page 258
 - [":CHANnel<n>:UNITs"](#) on page 235

:FUNCTION Commands

Control functions in the measurement/storage module. See "Introduction to :FUNCTION Commands" on page 266.

Table 65 :FUNCTION Commands Summary

Command	Query	Options and Query Returns
:FUNCTION:CENTer <frequency> (see page 267)	:FUNCTION:CENTer? (see page 267)	<frequency> ::= the current center frequency in NR3 format. The range of legal values is from 0 Hz to 25 GHz.
:FUNCTION:DISPlay {{0 OFF} {1 ON}} (see page 268)	:FUNCTION:DISPlay? (see page 268)	{0 1}
:FUNCTION:GOFT:OPERat ion <operation> (see page 269)	:FUNCTION:GOFT:OPERat ion? (see page 269)	<operation> ::= {ADD SUBtract MULTiply}
:FUNCTION:GOFT:SOURce 1 <source> (see page 270)	:FUNCTION:GOFT:SOURce 1? (see page 270)	<source> ::= CHANnel<n> <n> ::= {1 2 3 4} for 4ch models <n> ::= {1 2} for 2ch models
:FUNCTION:GOFT:SOURce 2 <source> (see page 271)	:FUNCTION:GOFT:SOURce 2? (see page 271)	<source> ::= CHANnel<n> <n> ::= {{1 2} {3 4}} for 4ch models, depending on SOURce1 selection <n> ::= {1 2} for 2ch models
:FUNCTION:OFFSet <offset> (see page 272)	:FUNCTION:OFFSet? (see page 272)	<offset> ::= the value at center screen in NR3 format. The range of legal values is +/-10 times the current sensitivity of the selected function.
:FUNCTION:OPERation <operation> (see page 273)	:FUNCTION:OPERation? (see page 273)	<operation> ::= {ADD SUBtract MULTiply INTegrate DIFFerentiate FFT SQRT}

Table 65 :FUNCTION Commands Summary (continued)

Command	Query	Options and Query Returns
:FUNCTION:RANGe <range> (see page 274)	:FUNCTION:RANGe? (see page 274)	<range> ::= the full-scale vertical axis value in NR3 format. The range for ADD, SUBT, MULT is 8E-6 to 800E+3. The range for the INTegrate function is 8E-9 to 400E+3. The range for the DIFFerentiate function is 80E-3 to 8.0E12 (depends on current sweep speed). The range for the FFT function is 8 to 800 dBV.
:FUNCTION:REFerence <level> (see page 275)	:FUNCTION:REFerence? (see page 275)	<level> ::= the value at center screen in NR3 format. The range of legal values is +/-10 times the current sensitivity of the selected function.
:FUNCTION:SCALe <scale value>[<suffix>] (see page 276)	:FUNCTION:SCALe? (see page 276)	<scale value> ::= integer in NR1 format <suffix> ::= {V dB}
:FUNCTION:SOURce1 <source> (see page 277)	:FUNCTION:SOURce1? (see page 277)	<source> ::= {CHANnel<n> GOFT} <n> ::= {1 2 3 4} for 4ch models <n> ::= {1 2} for 2ch models GOFT is only for FFT, INTegrate, DIFFerentiate, and SQRT operations.
:FUNCTION:SOURce2 <source> (see page 278)	:FUNCTION:SOURce2? (see page 278)	<source> ::= {CHANnel<n> NONE} <n> ::= {{1 2} {3 4}} for 4ch models, depending on SOURce1 selection <n> ::= {1 2} for 2ch models
:FUNCTION:SPAN (see page 279)	:FUNCTION:SPAN? (see page 279)	 ::= the current frequency span in NR3 format. Legal values are 1 Hz to 100 GHz.
:FUNCTION:WINDow <window> (see page 280)	:FUNCTION:WINDow? (see page 280)	<window> ::= {RECTangular HANNing FLATtop BHARRis}

Introduction to :FUNCTION Commands The FUNCTION subsystem controls the math functions in the oscilloscope. Add, subtract, multiply, differentiate, integrate, square root, and FFT (Fast Fourier Transform) operations are available. These math operations only use the analog (vertical) channels.

The SOURce1, DISPlay, RANGE, and OFFSet commands apply to any function. The SPAN, CENTER, and WINDow commands are only useful for FFT functions. When FFT is selected, the cursors change from volts and time to decibels (dB) and frequency (Hz).

Reporting the Setup

Use :FUNCTION? to query setup information for the FUNCTION subsystem.

Return Format

The following is a sample response from the :FUNCTION? queries. In this case, the query was issued following a *RST command.

```
:FUNC:OPER ADD;DISP 0;SOUR1 CHAN1;SOUR2 CHAN2;RANG +8.00E+00;OFFS  
+0.0E+00;:FUNC:GOFT:OPER ADD;SOUR1 CHAN1;SOUR2 CHAN2
```

:FUNCTION:CENTer

N (see [page 786](#))

Command Syntax :FUNCTION:CENTer <frequency>

<frequency> ::= the current center frequency in NR3 format. The range of legal values is from 0 Hz to 25 GHz.

The :FUNCTION:CENTer command sets the center frequency when FFT (Fast Fourier Transform) is selected.

Query Syntax :FUNCTION:CENTer?

The :FUNCTION:CENTer? query returns the current center frequency in Hertz.

Return Format <frequency><NL>

<frequency> ::= the current center frequency in NR3 format. The range of legal values is from 0 Hz to 25 GHz.

NOTE

After a *RST (Reset) or :AUToscale command, the values returned by the :FUNCTION:CENTer? and :FUNCTION:SPAN? queries depend on the current :TIMEbase:RANGe value. Once you change either the :FUNCTION:CENTer or :FUNCTION:SPAN value, they no longer track the :TIMEbase:RANGe value.

- See Also**
- "[Introduction to :FUNCTION Commands](#)" on page 266
 - "[:FUNCTION:SPAN](#)" on page 279
 - "[:TIMEbase:RANGe](#)" on page 459
 - "[:TIMEbase:SCALE](#)" on page 462

:FUNCTION:DISPlay

N (see [page 786](#))

Command Syntax :FUNCTION:DISPlay <display>
<display> ::= {{1 | ON} | {0 | OFF}}

The :FUNCTION:DISPlay command turns the display of the function on or off. When ON is selected, the function performs as specified using the other FUNCTION commands. When OFF is selected, function is neither calculated nor displayed.

Query Syntax :FUNCTION:DISPlay?

The :FUNCTION:DISPlay? query returns whether the function display is on or off.

Return Format <display><NL>
<display> ::= {1 | 0}

- See Also**
- ["Introduction to :FUNCTION Commands"](#) on page 266
 - [":VIEW"](#) on page 180
 - [":BLANK"](#) on page 148
 - [":STATus"](#) on page 177

:FUNCTION:GOFT:OPERation

N (see [page 786](#))

Command Syntax :FUNCTION:GOFT:OPERation <operation>

<operation> ::= {ADD | SUBTract | MULTiPLY}

The :FUNCTION:GOFT:OPERation command sets the math operation for the g(t) source that can be used as the input to the FFT, INTegrate, DIFFerentiate, or SQRT functions:

- ADD – Source1 + source2.
- SUBTract – Source1 - source2.
- MULTiPLY – Source1 * source2.

The :FUNCTION:GOFT:SOURce1 and :FUNCTION:GOFT:SOURce2 commands are used to select source1 and source2.

Query Syntax :FUNCTION:GOFT:OPERation?

The :FUNCTION:GOFT:OPERation? query returns the current g(t) source operation setting.

Return Format <operation><NL>

<operation> ::= {ADD | SUBT | MULT}

- See Also**
- ["Introduction to :FUNCTION Commands"](#) on page 266
 - [":FUNCTION:GOFT:SOURce1"](#) on page 270
 - [":FUNCTION:GOFT:SOURce2"](#) on page 271
 - [":FUNCTION:SOURce1"](#) on page 277

:FUNCTION:GOFT:SOURce1

N (see [page 786](#))

Command Syntax :FUNCTION:GOFT:SOURce1 <value>
<value> ::= CHANnel<n>
<n> ::= {1 | 2 | 3 | 4} for 4ch models
<n> ::= {1 | 2} for 2ch models

The :FUNCTION:GOFT:SOURce1 command selects the first input channel for the g(t) source that can be used as the input to the FFT, INTEGRate, DIFFerentiate, or SQRT functions.

Query Syntax :FUNCTION:GOFT:SOURce1?

The :FUNCTION:GOFT:SOURce1? query returns the current selection for the first input channel for the g(t) source.

Return Format <value><NL>
<value> ::= CHAN<n>
<n> ::= {1 | 2 | 3 | 4} for the 4ch models
<n> ::= {1 | 2} for the 2ch models

- See Also**
- ["Introduction to :FUNCTION Commands"](#) on page 266
 - [":FUNCTION:GOFT:SOURce2"](#) on page 271
 - [":FUNCTION:GOFT:OPERation"](#) on page 269

:FUNCTION:GOFT:SOURce2

N (see [page 786](#))

Command Syntax :FUNCTION:GOFT:SOURce2 <value>

<value> ::= CHANnel<n>

<n> ::= {{1 | 2} | {3 | 4}} for 4ch models, depending on SOURce1 selection

<n> ::= {1 | 2} for 2ch models

The :FUNCTION:GOFT:SOURce2 command selects the second input channel for the g(t) source that can be used as the input to the FFT, INTegrate, DIFFerentiate, or SQRT functions.

If CHANnel1 or CHANnel2 is selected for :FUNCTION:GOFT:SOURce1, the SOURce2 selection can be CHANnel1 or CHANnel2. Likewise, if CHANnel3 or CHANnel4 is selected for :FUNCTION:GOFT:SOURce1, the SOURce2 selection can be CHANnel3 or CHANnel4.

Query Syntax :FUNCTION:GOFT:SOURce2?

The :FUNCTION:GOFT:SOURce2? query returns the current selection for the second input channel for the g(t) source.

Return Format <value><NL>

<value> ::= CHAN<n>

<n> ::= {{1 | 2} | {3 | 4}} for 4ch models, depending on SOURce1 selection

<n> ::= {1 | 2} for 2ch models

- See Also**
- ["Introduction to :FUNCTION Commands"](#) on page 266
 - [":FUNCTION:GOFT:SOURce1"](#) on page 270
 - [":FUNCTION:GOFT:OPERation"](#) on page 269

:FUNCTION:OFFSet

N (see [page 786](#))

Command Syntax :FUNCTION:OFFSet <offset>

<offset> ::= the value at center screen in NR3 format.

The :FUNCTION:OFFSet command sets the voltage or vertical value represented at center screen for the selected function. The range of legal values is generally +/- 10 times the current scale of the selected function, but will vary by function. If you set the offset to a value outside of the legal range, the offset value is automatically set to the nearest legal value.

NOTE

The :FUNCTION:OFFSet command is equivalent to the :FUNCTION:REFerence command.

Query Syntax :FUNCTION:OFFSet?

The :FUNCTION:OFFSet? query outputs the current offset value for the selected function.

Return Format <offset><NL>

<offset> ::= the value at center screen in NR3 format.

- See Also**
- "[Introduction to :FUNCTION Commands](#)" on page 266
 - "[:FUNCTION:RANGE](#)" on page 274
 - "[:FUNCTION:REFerence](#)" on page 275
 - "[:FUNCTION:SCALE](#)" on page 276

:FUNCTION:OPERation

N (see [page 786](#))

Command Syntax :FUNCTION:OPERation <operation>

```
<operation> ::= {ADD | SUBtract | MULTiply | INTegrate | DIFFerentiate
                | FFT | SQRT}
```

The :FUNCTION:OPERation command sets the desired waveform math operation:

- ADD – Source1 + source2.
- SUBtract – Source1 - source2.
- MULTiply – Source1 * source2.
- INTegrate – Integrate the selected waveform source.
- DIFFerentiate – Differentiate the selected waveform source.
- FFT – Fast Fourier Transform on the selected waveform source.
- SQRT – Square root on the selected waveform source.

When the operation is ADD, SUBtract, or MULTiply, the :FUNCTION:SOURce1 and :FUNCTION:SOURce2 commands are used to select source1 and source2. For all other operations, the :FUNCTION:SOURce1 command selects the waveform source.

Query Syntax :FUNCTION:OPERation?

The :FUNCTION:OPERation? query returns the current operation for the selected function.

Return Format <operation><NL>

```
<operation> ::= {ADD | SUBT | MULT | INT | DIFF | FFT | SQRT}
```

- See Also**
- ["Introduction to :FUNCTION Commands"](#) on page 266
 - [":FUNCTION:SOURce1"](#) on page 277
 - [":FUNCTION:SOURce2"](#) on page 278

:FUNCTION:RANGe

N (see [page 786](#))

Command Syntax :FUNCTION:RANGe <range>

<range> ::= the full-scale vertical axis value in NR3 format.

The :FUNCTION:RANGe command defines the full-scale vertical axis for the selected function.

Query Syntax :FUNCTION:RANGe?

The :FUNCTION:RANGe? query returns the current full-scale range value for the selected function.

Return Format <range><NL>

<range> ::= the full-scale vertical axis value in NR3 format.

The range for ADD, SUBT, MULT is 8E-6 to 800E+3.

The range for the INTegrate function is 8E-9 to 400E+3 (depends on sweep speed).

The range for the DIFFerentiate function is 80E-3 to 8.0E12 (depends on sweep speed).

The range for the FFT (Fast Fourier Transform) function is 8 to 800 dBV.

- See Also**
- "Introduction to :FUNCTION Commands" on page 266
 - ":FUNCTION:SCALE" on page 276

:FUNCTION:REFERENCE

N (see [page 786](#))

Command Syntax :FUNCTION:REFERENCE <level>

<level> ::= the current reference level in NR3 format.

The :FUNCTION:REFERENCE command sets the voltage or vertical value represented at center screen for the selected function. The range of legal values is generally +/- 10 times the current scale of the selected function, but will vary by function. If you set the reference level to a value outside of the legal range, the level is automatically set to the nearest legal value.

NOTE

The FUNCTION:REFERENCE command is equivalent to the :FUNCTION:OFFSET command.

Query Syntax :FUNCTION:REFERENCE?

The :FUNCTION:REFERENCE? query outputs the current reference level value for the selected function.

Return Format <level><NL>

<level> ::= the current reference level in NR3 format.

- See Also**
- ["Introduction to :FUNCTION Commands"](#) on page 266
 - [":FUNCTION:OFFSET"](#) on page 272
 - [":FUNCTION:RANGE"](#) on page 274
 - [":FUNCTION:SCALE"](#) on page 276

:FUNCTION:SCALE

N (see [page 786](#))

Command Syntax :FUNCTION:SCALE <scale value>[<suffix>]
<scale value> ::= integer in NR1 format
<suffix> ::= {V | dB}

The :FUNCTION:SCALE command sets the vertical scale, or units per division, of the selected function. Legal values for the scale depend on the selected function.

Query Syntax :FUNCTION:SCALE?

The :FUNCTION:SCALE? query returns the current scale value for the selected function.

Return Format <scale value><NL>
<scale value> ::= integer in NR1 format

- See Also**
- ["Introduction to :FUNCTION Commands"](#) on page 266
 - [":FUNCTION:RANGE"](#) on page 274

:FUNCTION:SOURce1

N (see [page 786](#))

Command Syntax :FUNCTION:SOURce1 <value>
 <value> ::= {CHANnel<n> | GOFT}
 <n> ::= {1 | 2 | 3 | 4} for 4ch models
 <n> ::= {1 | 2} for 2ch models

The :FUNCTION:SOURce1 command is used for any :FUNCTION:OPERation selection (including the ADD, SUBTract, or MULTiPLY channel math operations and the FFT, INTegrate, DIFFerentiate, or SQRT transforms). This command selects the first source for channel math operations or the single source for the transforms.

The GOFT parameter is only available for the FFT, INTegrate, DIFFerentiate, or SQRT functions. It lets you specify, as the function input source, the addition, subtraction, or multiplication of two channels. When GOFT is used, the g(t) source is specified by the :FUNCTION:GOFT:OPERation, :FUNCTION:GOFT:SOURce1, and :FUNCTION:GOFT:SOURce2 commands.

NOTE

Another shorthand notation for SOURce1 in this command/query (besides SOUR1) is SOUR.

Query Syntax :FUNCTION:SOURce1?

The :FUNCTION:SOURce1? query returns the current source1 for function operations.

Return Format <value><NL>
 <value> ::= {CHAN<n> | GOFT}
 <n> ::= {1 | 2 | 3 | 4} for 4ch models
 <n> ::= {1 | 2} for 2ch models

- See Also**
- "[Introduction to :FUNCTION Commands](#)" on page 266
 - "[:FUNCTION:OPERation](#)" on page 273
 - "[:FUNCTION:GOFT:OPERation](#)" on page 269
 - "[:FUNCTION:GOFT:SOURce1](#)" on page 270
 - "[:FUNCTION:GOFT:SOURce2](#)" on page 271

:FUNCTION:SOURce2

N (see [page 786](#))

Command Syntax :FUNCTION:SOURce2 <value>

<value> ::= {CHANnel<n> | NONE}

<n> ::= {{1 | 2} | {3 | 4}} for 4ch models, depending on SOURce1 selection

<n> ::= {1 | 2} for 2ch models

The :FUNCTION:SOURce2 command is only used when an FFT (Fast Fourier Transform), DIFF, or INT operation is selected (see the:FUNCTION:OPERation command for more information about selecting an operation). The :FUNCTION:SOURce2 command selects the source for function operations. Choose CHANnel<n>, or ADD, SUBT, or MULT to specify the desired source for function DIFFerentiate, INTegrate, and FFT operations specified by the :FUNCTION:OPERation command.

If CHANnel1 or CHANnel2 is selected for :FUNCTION:SOURce1, the SOURce2 selection can be CHANnel1 or CHANnel2. Likewise, if CHANnel3 or CHANnel4 is selected for :FUNCTION:SOURce1, the SOURce2 selection can be CHANnel3 or CHANnel4.

Query Syntax :FUNCTION:SOURce2?

The :FUNCTION:SOURce2? query returns the second source for function operations on two waveforms.

Return Format <value><NL>

<value> ::= {CHAN<n> | NONE}

<n> ::= {{1 | 2} | {3 | 4}} for 4ch models, depending on SOURce1 selection

<n> ::= {1 | 2} for 2ch models

- See Also**
- ["Introduction to :FUNCTION Commands"](#) on page 266
 - [":FUNCTION:OPERation"](#) on page 273

:FUNCTION:SPAN

N (see [page 786](#))

Command Syntax :FUNCTION:SPAN

 ::= the current frequency span in NR3 format. Legal values are 1 Hz to 100 GHz.

If you set the frequency span to a value outside of the legal range, the step size is automatically set to the nearest legal value.

The :FUNCTION:SPAN command sets the frequency span of the display (left graticule to right graticule) when FFT (Fast Fourier Transform) is selected.

Query Syntax :FUNCTION:SPAN?

The :FUNCTION:SPAN? query returns the current frequency span in Hertz.

NOTE

After a *RST (Reset) or :AUToscale command, the values returned by the :FUNCTION:CENTer? and :FUNCTION:SPAN? queries depend on the current :TIMEbase:RANGe value. Once you change either the :FUNCTION:CENTer or :FUNCTION:SPAN value, they no longer track the :TIMEbase:RANGe value.

Return Format <NL>

 ::= the current frequency span in NR3 format. Legal values are 1 Hz to 100 GHz.

- See Also**
- ["Introduction to :FUNCTION Commands"](#) on page 266
 - [":FUNCTION:CENTer"](#) on page 267
 - [":TIMEbase:RANGe"](#) on page 459
 - [":TIMEbase:SCALE"](#) on page 462

:FUNCTION:WINDow

N (see [page 786](#))

Command Syntax :FUNCTION:WINDow <window>

<window> ::= {RECTangular | HANNing | FLATtop | BHARris}

The :FUNCTION:WINDow command allows the selection of four different windowing transforms or operations for the FFT (Fast Fourier Transform) function.

The FFT operation assumes that the time record repeats. Unless an integral number of sampled waveform cycles exist in the record, a discontinuity is created between the end of one record and the beginning of the next. This discontinuity introduces additional frequency components about the peaks into the spectrum. This is referred to as leakage. To minimize leakage, windows that approach zero smoothly at the start and end of the record are employed as filters to the FFTs. Each window is useful for certain classes of input signals.

- RECTangular – useful for transient signals, and signals where there are an integral number of cycles in the time record.
- HANNing – useful for frequency resolution and general purpose use. It is good for resolving two frequencies that are close together, or for making frequency measurements. This is the default window.
- FLATtop – best for making accurate amplitude measurements of frequency peaks.
- BHARris (Blackman-Harris) – reduces time resolution compared to the rectangular window, but it improves the capacity to detect smaller impulses due to lower secondary lobes (provides minimal spectral leakage).

Query Syntax :FUNCTION:WINDow?

The :FUNCTION:WINDow? query returns the value of the window selected for the FFT function.

Return Format <window><NL>

<window> ::= {RECT | HANN | FLAT | BHAR}

See Also • ["Introduction to :FUNCTION Commands"](#) on page 266

:HARDcopy Commands

Set and query the selection of hardcopy device and formatting options. See "[Introduction to :HARDcopy Commands](#)" on page 282.

Table 66 :HARDcopy Commands Summary

Command	Query	Options and Query Returns
:HARDcopy:AREA <area> (see page 283)	:HARDcopy:AREA? (see page 283)	<area> ::= SCReen
:HARDcopy:APRinter <active_printer> (see page 284)	:HARDcopy:APRinter? (see page 284)	<active_printer> ::= {<index> <name>} <index> ::= integer index of printer in list <name> ::= name of printer in list
:HARDcopy:FACTors {{0 OFF} {1 ON}} (see page 285)	:HARDcopy:FACTors? (see page 285)	{0 1}
:HARDcopy:FFEed {{0 OFF} {1 ON}} (see page 286)	:HARDcopy:FFEed? (see page 286)	{0 1}
:HARDcopy:INKSaver {{0 OFF} {1 ON}} (see page 287)	:HARDcopy:INKSaver? (see page 287)	{0 1}
:HARDcopy:LAYout <layout> (see page 288)	:HARDcopy:LAYout? (see page 288)	<layout> ::= {LANDscape PORTRait}
:HARDcopy:PALette <palette> (see page 289)	:HARDcopy:PALette? (see page 289)	<palette> ::= {COLor GRAYscale NONE}
n/a	:HARDcopy:PRINter:LIS T? (see page 290)	<list> ::= [<printer_spec>] ... [printer_spec] <printer_spec> ::= "<index>,<active>,<name>;" <index> ::= integer index of printer <active> ::= {Y N} <name> ::= name of printer
:HARDcopy:STARt (see page 291)	n/a	n/a

5 Commands by Subsystem

Introduction to :HARDcopy Commands The HARDcopy subsystem provides commands to set and query the selection of hardcopy device and formatting options such as inclusion of instrument settings (FACTors) and generation of formfeed (FFEed).

:HARDC is an acceptable short form for :HARDcopy.

Reporting the Setup

Use :HARDcopy? to query setup information for the HARDcopy subsystem.

Return Format

The following is a sample response from the :HARDcopy? query. In this case, the query was issued following the *RST command.

```
:HARD:APR " ";AREA SCR;FACT 0;FFE 0;INKS 1;PAL NONE;LAY PORT
```

:HARDcopy:AREA

N (see [page 786](#))

Command Syntax :HARDcopy:AREA <area>

<area> ::= SCReen

The :HARDcopy:AREA command controls what part of the display area is printed. Currently, the only legal choice is SCReen.

Query Syntax :HARDcopy:AREA?

The :HARDcopy:AREA? query returns the selected display area.

Return Format <area><NL>

<area> ::= SCR

- See Also**
- ["Introduction to :HARDcopy Commands"](#) on page 282
 - [":HARDcopy:START"](#) on page 291
 - [":HARDcopy:APRinter"](#) on page 284
 - [":HARDcopy:PRINter:LIST"](#) on page 290
 - [":HARDcopy:FACTors"](#) on page 285
 - [":HARDcopy:FFEed"](#) on page 286
 - [":HARDcopy:INKSaver"](#) on page 287
 - [":HARDcopy:LAYout"](#) on page 288
 - [":HARDcopy:PALette"](#) on page 289

:HARDcopy:APRinter

N (see [page 786](#))

Command Syntax :HARDcopy:APRinter <active_printer>
<active_printer> ::= {<index> | <name>}
<index> ::= integer index of printer in list
<name> ::= name of printer in list

The :HARDcopy:APRinter command sets the active printer.

Query Syntax :HARDcopy:APRinter?

The :HARDcopy:APRinter? query returns the name of the active printer.

Return Format <name><NL>
<name> ::= name of printer in list

- See Also**
- ["Introduction to :HARDcopy Commands"](#) on page 282
 - [":HARDcopy:PRINter:LIST"](#) on page 290
 - [":HARDcopy:STArT"](#) on page 291

:HARDcopy:FACTors

N (see [page 786](#))

Command Syntax :HARDcopy:FACTors <factors>
 <factors> ::= {{OFF | 0} | {ON | 1}}

The HARDcopy:FACTors command controls whether the scale factors are output on the hardcopy dump.

Query Syntax :HARDcopy:FACTors?

The :HARDcopy:FACTors? query returns a flag indicating whether oscilloscope instrument settings are output on the hardcopy.

Return Format <factors><NL>
 <factors> ::= {0 | 1}

- See Also**
- ["Introduction to :HARDcopy Commands"](#) on page 282
 - [":HARDcopy:START"](#) on page 291
 - [":HARDcopy:FFEed"](#) on page 286
 - [":HARDcopy:INKSaver"](#) on page 287
 - [":HARDcopy:LAYout"](#) on page 288
 - [":HARDcopy:PALETTE"](#) on page 289

:HARDcopy:FFEed

N (see [page 786](#))

Command Syntax :HARDcopy:FFEed <ffeed>
<ffeed> ::= {{OFF | 0} | {ON | 1}}

The HARDcopy:FFEed command controls whether a formfeed is output between the screen image and factors of a hardcopy dump.

ON (or 1) is only valid when PRINter0 or PRINter1 is set as the :HARDcopy:FORMat type.

Query Syntax :HARDcopy:FFEed?

The :HARDcopy:FFEed? query returns a flag indicating whether a formfeed is output at the end of the hardcopy dump.

Return Format <ffeed><NL>
<ffeed> ::= {0 | 1}

- See Also**
- ["Introduction to :HARDcopy Commands"](#) on page 282
 - [":HARDcopy:START"](#) on page 291
 - [":HARDcopy:FACTors"](#) on page 285
 - [":HARDcopy:INKSaver"](#) on page 287
 - [":HARDcopy:LAYout"](#) on page 288
 - [":HARDcopy:PALette"](#) on page 289

:HARDcopy:INKSaver

N (see [page 786](#))

Command Syntax :HARDcopy:INKSaver <value>
 <value> ::= {{OFF | 0} | {ON | 1}}

The HARDcopy:INKSaver command controls whether the graticule colors are inverted or not.

Query Syntax :HARDcopy:INKSaver?

The :HARDcopy:INKSaver? query returns a flag indicating whether graticule colors are inverted or not.

Return Format <value><NL>
 <value> ::= {0 | 1}

- See Also**
- ["Introduction to :HARDcopy Commands"](#) on page 282
 - [":HARDcopy:START"](#) on page 291
 - [":HARDcopy:FACTors"](#) on page 285
 - [":HARDcopy:FFEed"](#) on page 286
 - [":HARDcopy:LAYout"](#) on page 288
 - [":HARDcopy:PALETTE"](#) on page 289

:HARDcopy:LAYout

N (see [page 786](#))

Command Syntax :HARDcopy:LAYout <layout>
<layout> ::= {LANDscape | PORTRait}

The :HARDcopy:LAYout command sets the hardcopy layout mode.

Query Syntax :HARDcopy:LAYout?

The :HARDcopy:LAYout? query returns the selected hardcopy layout mode.

Return Format <layout><NL>
<layout> ::= {LAND | PORT}

- See Also**
- ["Introduction to :HARDcopy Commands"](#) on page 282
 - [":HARDcopy:START"](#) on page 291
 - [":HARDcopy:FACTors"](#) on page 285
 - [":HARDcopy:PALETTE"](#) on page 289
 - [":HARDcopy:FFeEd"](#) on page 286
 - [":HARDcopy:INKSaver"](#) on page 287

:HARDcopy:PALETTE

N (see [page 786](#))

Command Syntax :HARDcopy:PALETTE <palette>
 <palette> ::= {COLOR | GRAYscale | NONE}

The :HARDcopy:PALETTE command sets the hardcopy palette color.

NOTE

If no printer is connected, NONE is the only valid parameter.

Query Syntax :HARDcopy:PALETTE?

The :HARDcopy:PALETTE? query returns the selected hardcopy palette color.

Return Format <palette><NL>
 <palette> ::= {COL | GRAY | NONE}

- See Also**
- ["Introduction to :HARDcopy Commands"](#) on page 282
 - [":HARDcopy:START"](#) on page 291
 - [":HARDcopy:FACTors"](#) on page 285
 - [":HARDcopy:LAYout"](#) on page 288
 - [":HARDcopy:FFEed"](#) on page 286
 - [":HARDcopy:INKSaver"](#) on page 287

:HARDcopy:PRINter:LIST

N (see [page 786](#))

Query Syntax :HARDcopy:PRINter:LIST?

The :HARDcopy:PRINter:LIST? query returns a list of available printers. The list can be empty.

Return Format <list><NL>

<list> ::= [<printer_spec>] ... [printer_spec>]

<printer_spec> ::= "<index>,<active>,<name>;"

<index> ::= integer index of printer

<active> ::= {Y | N}

<name> ::= name of printer (for example "DESKJET 950C")

- See Also**
- ["Introduction to :HARDcopy Commands"](#) on page 282
 - [":HARDcopy:APRinter"](#) on page 284
 - [":HARDcopy:STArT"](#) on page 291

:HARDcopy:START

N (see [page 786](#))

Command Syntax :HARDcopy:START

The :HARDcopy:START command starts a print job.

- See Also**
- "[Introduction to :HARDcopy Commands](#)" on page 282
 - "[:HARDcopy:APRinter](#)" on page 284
 - "[:HARDcopy:PRINter:LIST](#)" on page 290
 - "[:HARDcopy:FACTors](#)" on page 285
 - "[:HARDcopy:FFEed](#)" on page 286
 - "[:HARDcopy:INKSaver](#)" on page 287
 - "[:HARDcopy:LAYout](#)" on page 288
 - "[:HARDcopy:PALETTE](#)" on page 289

:LISTer Commands

Table 67 :LISTer Commands Summary

Command	Query	Options and Query Returns
n/a	:LISTer:DATA? (see page 293)	<binary_block> ::= comma-separated data with newlines at the end of each row
:LISTer:DISPlay {{0 OFF} {1 ON}} (see page 294)	:LISTer:DISPlay? (see page 294)	{0 1}

Introduction to :LISTer Commands The LISTer subsystem is used to turn on/off the serial decode Lister display and return data from the Lister display.

:LISTer:DATA

N (see [page 786](#))

Query Syntax :LISTer:DATA?

The :LISTer:DATA? query returns the lister data.

Return Format <binary_block><NL>

<binary_block> ::= comma-separated data with newlines at the end of each row

- See Also**
- ["Introduction to :LISTer Commands"](#) on page 292
 - [":LISTer:DISPlay"](#) on page 294
 - ["Definite-Length Block Response Data"](#) on page 109

:LISTer:DISPlay

N (see [page 786](#))

Command Syntax :LISTer:DISPlay <value>
<value> ::= {{1 | ON} | {0 | OFF}}

The :LISTer:DISPlay command turns on or off the on-screen lister display.

Query Syntax :LISTer:DISPlay?

The :LISTer:DISPlay? query returns lister display setting.

Return Format <value><NL>
<value> ::= {0 | 1}

- See Also**
- "[Introduction to :LISTer Commands](#)" on page 292
 - "[:LISTer:DATA](#)" on page 293

:MARKer Commands

Set and query the settings of X-axis markers (X1 and X2 cursors) and the Y-axis markers (Y1 and Y2 cursors). See "[Introduction to :MARKer Commands](#)" on page 296.

Table 68 :MARKer Commands Summary

Command	Query	Options and Query Returns
:MARKer:MODE <mode> (see page 297)	:MARKer:MODE? (see page 297)	<mode> ::= {OFF MEASurement MANual WAVeform}
:MARKer:X1Position <position>[suffix] (see page 298)	:MARKer:X1Position? (see page 298)	<position> ::= X1 cursor position value in NR3 format [suffix] ::= {s ms us ns ps Hz kHz MHz} <return_value> ::= X1 cursor position value in NR3 format
:MARKer:X1Y1source <source> (see page 299)	:MARKer:X1Y1source? (see page 299)	<source> ::= {CHANnel<n> FUNCTION MATH} <n> ::= 1-2 or 1-4 in NR1 format <return_value> ::= <source>
:MARKer:X2Position <position>[suffix] (see page 300)	:MARKer:X2Position? (see page 300)	<position> ::= X2 cursor position value in NR3 format [suffix] ::= {s ms us ns ps Hz kHz MHz} <return_value> ::= X2 cursor position value in NR3 format
:MARKer:X2Y2source <source> (see page 301)	:MARKer:X2Y2source? (see page 301)	<source> ::= {CHANnel<n> FUNCTION MATH} <n> ::= 1-2 or 1-4 in NR1 format <return_value> ::= <source>
n/a	:MARKer:XDELta? (see page 302)	<return_value> ::= X cursors delta value in NR3 format
:MARKer:Y1Position <position>[suffix] (see page 303)	:MARKer:Y1Position? (see page 303)	<position> ::= Y1 cursor position value in NR3 format [suffix] ::= {V mV dB} <return_value> ::= Y1 cursor position value in NR3 format

Table 68 :MARKer Commands Summary (continued)

Command	Query	Options and Query Returns
:MARKer:Y2Position <position>[suffix] (see page 304)	:MARKer:Y2Position? (see page 304)	<position> ::= Y2 cursor position value in NR3 format [suffix] ::= {V mV dB} <return_value> ::= Y2 cursor position value in NR3 format
n/a	:MARKer:YDELta? (see page 305)	<return_value> ::= Y cursors delta value in NR3 format

Introduction to :MARKer Commands The MARKer subsystem commands set and query the settings of X-axis markers (X1 and X2 cursors) and the Y-axis markers (Y1 and Y2 cursors). You can set and query the marker mode and source, the position of the X and Y cursors, and query delta X and delta Y cursor values.

Reporting the Setup

Use :MARKer? to query setup information for the MARKer subsystem.

Return Format

The following is a sample response from the :MARKer? query. In this case, the query was issued following a *RST and :MARKer:MODE:MANual command.

```
:MARK:X1Y1 NONE;X2Y2 NONE;MODE OFF
```

:MARKer:MODE

N (see [page 786](#))

Command Syntax :MARKer:MODE <mode>

<mode> ::= {OFF | MEASurement | MANual | WAVeform}

The :MARKer:MODE command sets the cursors mode:

- OFF – removes the cursor information from the display.
- MANual – enables manual placement of the X and Y cursors.

If the front-panel cursors are off, or are set to the front-panel Hex or Binary mode, setting :MARKer:MODE MANual will put the cursors in the front-panel Normal mode.

- MEASurement – cursors track the most recent measurement.

Setting the mode to MEASurement sets the marker sources (:MARKer:X1Y1source and :MARKer:X2Y2source) to the measurement source (:MEASure:SOURce). Setting the measurement source remotely always sets the marker sources.

- WAVeform – the Y1 cursor tracks the voltage value at the X1 cursor of the waveform specified by the X1Y1source, and the Y2 cursor does the same for the X2 cursor and its X2Y2source.

Query Syntax :MARKer:MODE?

The :MARKer:MODE? query returns the current cursors mode.

Return Format <mode><NL>

<mode> ::= {OFF | MEAS | MAN | WAV}

- See Also**
- ["Introduction to :MARKer Commands"](#) on page 296
 - [":MARKer:X1Y1source"](#) on page 299
 - [":MARKer:X2Y2source"](#) on page 301
 - [":MEASure:SOURce"](#) on page 337
 - [":MARKer:X1Position"](#) on page 298
 - [":MARKer:X2Position"](#) on page 300
 - [":MARKer:Y1Position"](#) on page 303
 - [":MARKer:Y2Position"](#) on page 304

:MARKer:X1Position

N (see [page 786](#))

Command Syntax :MARKer:X1Position <position> [suffix]
 <position> ::= X1 cursor position in NR3 format
 <suffix> ::= {s | ms | us | ns | ps | Hz | kHz | MHz}

The :MARKer:X1Position command:

- Sets :MARKer:MODE to MANual if it is not currently set to WAVEform (see [":MARKer:MODE"](#) on [page 297](#)).
- Sets the X1 cursor position to the specified value.

Query Syntax :MARKer:X1Position?

The :MARKer:X1Position? query returns the current X1 cursor position. This is functionally equivalent to the obsolete :MEASure:TSTArt command/query.

NOTE

If the front-panel cursors are off, the marker position values are not defined and an error is generated. Make sure to set :MARKer:MODE to MANual or WAVEform to put the cursors in the front-panel Normal mode.

Return Format <position><NL>
 <position> ::= X1 cursor position in NR3 format

- See Also**
- ["Introduction to :MARKer Commands"](#) on [page 296](#)
 - [":MARKer:MODE"](#) on [page 297](#)
 - [":MARKer:X2Position"](#) on [page 300](#)
 - [":MARKer:X1Y1source"](#) on [page 299](#)
 - [":MARKer:X2Y2source"](#) on [page 301](#)
 - [":MEASure:TSTArt"](#) on [page 719](#)

:MARKer:X1Y1source

N (see [page 786](#))

Command Syntax :MARKer:X1Y1source <source>
 <source> ::= {CHANnel<n> | FUNCTION | MATH}
 <n> ::= {1 | 2 | 3 | 4} for the four channel oscilloscope models
 <n> ::= {1 | 2} for the two channel oscilloscope models

The :MARKer:X1Y1source command sets the source for the cursors. The channel you specify must be enabled for cursors to be displayed. If the channel or function is not on, an error message is issued.

If the marker mode is not currently WAVEform (see [":MARKer:MODE"](#) on [page 297](#)):

- Sending a :MARKer:X1Y1source command will put the cursors in the MANual mode.
- Setting the source for one pair of markers (for example, X1Y1) sets the source for the other (for example, X2Y2).

If the marker mode is currently WAVEform, the X1Y1 source can be set separate from the X2Y2 source.

If :MARKer:MODE is set to OFF or MANual, setting :MEASure:SOURce to CHANnel<n>, FUNCTION, or MATH will also set :MARKer:X1Y1source and :MARKer:X2Y2source to this value.

NOTE

MATH is an alias for FUNCTION. The query will return FUNC if the source is FUNCTION or MATH.

Query Syntax :MARKer:X1Y1source?

The :MARKer:X1Y1source? query returns the current source for the cursors. If all channels are off or if :MARKer:MODE is set to OFF, the query returns NONE.

Return Format <source><NL>
 <source> ::= {CHAN<n> | FUNC | NONE}

- See Also**
- ["Introduction to :MARKer Commands"](#) on [page 296](#)
 - [":MARKer:MODE"](#) on [page 297](#)
 - [":MARKer:X2Y2source"](#) on [page 301](#)
 - [":MEASure:SOURce"](#) on [page 337](#)

:MARKer:X2Position

N (see [page 786](#))

Command Syntax :MARKer:X2Position <position> [suffix]
 <position> ::= X2 cursor position in NR3 format
 <suffix> ::= {s | ms | us | ns | ps | Hz | kHz | MHz}

The :MARKer:X2Position command:

- Sets :MARKer:MODE to MANual if it is not currently set to WAVEform (see [":MARKer:MODE"](#) on [page 297](#)).
- Sets the X2 cursor position to the specified value.

Query Syntax :MARKer:X2Position?

The :MARKer:X2Position? query returns current X2 cursor position. This is functionally equivalent to the obsolete :MEASure:TSTOp command/query.

NOTE

If the front-panel cursors are off, the marker position values are not defined and an error is generated. Make sure to set :MARKer:MODE to MANual or WAVEform to put the cursors in the front-panel Normal mode.

Return Format <position><NL>
 <position> ::= X2 cursor position in NR3 format

- See Also**
- ["Introduction to :MARKer Commands"](#) on [page 296](#)
 - [":MARKer:MODE"](#) on [page 297](#)
 - [":MARKer:X1Position"](#) on [page 298](#)
 - [":MARKer:X2Y2source"](#) on [page 301](#)
 - [":MEASure:TSTOp"](#) on [page 720](#)

:MARKer:X2Y2source

N (see [page 786](#))

Command Syntax :MARKer:X2Y2source <source>

<source> ::= {CHANnel<n> | FUNCTION | MATH}

<n> ::= {1 | 2 | 3 | 4} for the four channel oscilloscope models

<n> ::= {1 | 2} for the two channel oscilloscope models

The :MARKer:X2Y2source command sets the source for the cursors. The channel you specify must be enabled for cursors to be displayed. If the channel or function is not on, an error message is issued.

If the marker mode is not currently WAVEform (see [":MARKer:MODE"](#) on [page 297](#)):

- Sending a :MARKer:X2Y2source command will put the cursors in the MANual mode.
- Setting the source for one pair of markers (for example, X2Y2) sets the source for the other (for example, X1Y1).

If the marker mode is currently WAVEform, the X2Y2 source can be set separate from the X1Y1 source.

If :MARKer:MODE is set to OFF or MANual, setting :MEASure:SOURce to CHANnel<n>, FUNCTION, or MATH will also set :MARKer:X1Y1source and :MARKer:X2Y2source to this value.

NOTE

MATH is an alias for FUNCTION. The query will return FUNC if the source is FUNCTION or MATH.

Query Syntax :MARKer:X2Y2source?

The :MARKer:X2Y2source? query returns the current source for the cursors. If all channels are off or if :MARKer:MODE is set to OFF, the query returns NONE.

Return Format <source><NL>

<source> ::= {CHAN<n> | FUNC | NONE}

- See Also**
- ["Introduction to :MARKer Commands"](#) on [page 296](#)
 - [":MARKer:MODE"](#) on [page 297](#)
 - [":MARKer:X1Y1source"](#) on [page 299](#)
 - [":MEASure:SOURce"](#) on [page 337](#)

:MARKer:XDELta

N (see [page 786](#))

Query Syntax :MARKer:XDELta?

The MARKer:XDELta? query returns the value difference between the current X1 and X2 cursor positions.

Xdelta = (Value at X2 cursor) - (Value at X1 cursor)

NOTE

If the front-panel cursors are off, the marker position values are not defined. Make sure to set :MARKer:MODE to MANual or WAVEform to put the cursors in the front-panel Normal mode.

Return Format <value><NL>

<value> ::= difference value in NR3 format.

- See Also**
- "[Introduction to :MARKer Commands](#)" on page 296
 - "[:MARKer:MODE](#)" on page 297
 - "[:MARKer:X1Position](#)" on page 298
 - "[:MARKer:X2Position](#)" on page 300
 - "[:MARKer:X1Y1source](#)" on page 299
 - "[:MARKer:X2Y2source](#)" on page 301

:MARKer:Y1Position

N (see [page 786](#))

Command Syntax :MARKer:Y1Position <position> [suffix]
 <position> ::= Y1 cursor position in NR3 format
 <suffix> ::= {mV | V | dB}

If the :MARKer:MODE is not currently set to WAVEform (see "[:MARKer:MODE](#)" on page 297), the :MARKer:Y1Position command:

- Sets :MARKer:MODE to MANual.
- Sets the Y1 cursor position to the specified value.

When the :MARKer:MODE is set to WAVEform, Y positions cannot be set.

Query Syntax :MARKer:Y1Position?

The :MARKer:Y1Position? query returns current Y1 cursor position. This is functionally equivalent to the obsolete :MEASure:VSTart command/query.

NOTE

If the front-panel cursors are off or are set to Binary or Hex Mode, the marker position values are not defined and an error is generated. Make sure to set :MARKer:MODE to MANual or WAVEform to put the cursors in the front-panel Normal mode.

Return Format <position><NL>
 <position> ::= Y1 cursor position in NR3 format

- See Also**
- "[Introduction to :MARKer Commands](#)" on page 296
 - "[:MARKer:MODE](#)" on page 297
 - "[:MARKer:X1Y1source](#)" on page 299
 - "[:MARKer:X2Y2source](#)" on page 301
 - "[:MARKer:Y2Position](#)" on page 304
 - "[:MEASure:VSTart](#)" on page 725

:MARKer:Y2Position

N (see [page 786](#))

Command Syntax :MARKer:Y2Position <position> [suffix]
 <position> ::= Y2 cursor position in NR3 format
 <suffix> ::= {mV | V | dB}

If the :MARKer:MODE is not currently set to WAVEform (see "[:MARKer:MODE](#)" on [page 297](#)), the :MARKer:Y1Position command:

- Sets :MARKer:MODE to MANual.
- Sets the Y2 cursor position to the specified value.

When the :MARKer:MODE is set to WAVEform, Y positions cannot be set.

Query Syntax :MARKer:Y2Position?

The :MARKer:Y2Position? query returns current Y2 cursor position. This is functionally equivalent to the obsolete :MEASure:VSTOP command/query.

NOTE

If the front-panel cursors are off or are set to Binary or Hex Mode, the marker position values are not defined and an error is generated. Make sure to set :MARKer:MODE to MANual or WAVEform to put the cursors in the front-panel Normal mode.

Return Format <position><NL>
 <position> ::= Y2 cursor position in NR3 format

- See Also**
- "[Introduction to :MARKer Commands](#)" on [page 296](#)
 - "[:MARKer:MODE](#)" on [page 297](#)
 - "[:MARKer:X1Y1source](#)" on [page 299](#)
 - "[:MARKer:X2Y2source](#)" on [page 301](#)
 - "[:MARKer:Y1Position](#)" on [page 303](#)
 - "[:MEASure:VSTOP](#)" on [page 726](#)

:MARKer:YDELta

N (see [page 786](#))

Query Syntax :MARKer:YDELta?

The :MARKer:YDELta? query returns the value difference between the current Y1 and Y2 cursor positions.

Ydelta = (Value at Y2 cursor) - (Value at Y1 cursor)

NOTE

If the front-panel cursors are off or are set to Binary or Hex Mode, the marker position values are not defined. Make sure to set :MARKer:MODE to MANual or WAVeform to put the cursors in the front-panel Normal mode.

Return Format <value><NL>

<value> ::= difference value in NR3 format

- See Also**
- ["Introduction to :MARKer Commands"](#) on page 296
 - [":MARKer:MODE"](#) on page 297
 - [":MARKer:X1Y1source"](#) on page 299
 - [":MARKer:X2Y2source"](#) on page 301
 - [":MARKer:Y1Position"](#) on page 303
 - [":MARKer:Y2Position"](#) on page 304

:MEASure Commands

Select automatic measurements to be made and control time markers. See "Introduction to :MEASure Commands" on page 312.

Table 69 :MEASure Commands Summary

Command	Query	Options and Query Returns
:MEASure:CLEar (see page 314)	n/a	n/a
:MEASure:COUNter [<source>] (see page 315)	:MEASure:COUNter? [<source>] (see page 315)	<source> ::= {CHANnel<n> EXTernal} for DSO models <source> ::= {CHANnel<n> DIGital0,..,DIGital15 EXTernal} for MSO models <n> ::= 1-2 or 1-4 in NR1 format <return_value> ::= counter frequency in Hertz in NR3 format
:MEASure:DEFine DELay, <delay spec> (see page 316)	:MEASure:DEFine? DELay (see page 317)	<delay spec> ::= <edge_spec1>,<edge_spec2> edge_spec1 ::= [<slope>]<occurrence> edge_spec2 ::= [<slope>]<occurrence> <slope> ::= {+ -} <occurrence> ::= integer
:MEASure:DEFine THResholds, <threshold spec> (see page 316)	:MEASure:DEFine? THResholds (see page 317)	<threshold spec> ::= {STANdard} {<threshold mode>,<upper>,<middle>,<lower>} <threshold mode> ::= {PERCent ABSolute}
:MEASure:DELay [<source1>] [,<source2>] (see page 319)	:MEASure:DELay? [<source1>] [,<source2>] (see page 319)	<source1,2> ::= {CHANnel<n> FUNction MATH} <n> ::= 1-2 or 1-4 in NR1 format <return_value> ::= floating-point number delay time in seconds in NR3 format
:MEASure:DUTYcycle [<source>] (see page 321)	:MEASure:DUTYcycle? [<source>] (see page 321)	<source> ::= {CHANnel<n> FUNction MATH} for DSO models <source> ::= {CHANnel<n> DIGital0,..,DIGital15 FUNction MATH} for MSO models <n> ::= 1-2 or 1-4 in NR1 format <return_value> ::= ratio of positive pulse width to period in NR3 format

Table 69 :MEASure Commands Summary (continued)

Command	Query	Options and Query Returns
:MEASure:FALLtime [<source>] (see page 322)	:MEASure:FALLtime? [<source>] (see page 322)	<source> ::= {CHANnel<n> FUNctIon MATH} for DSO models <source> ::= {CHANnel<n> DIGital0,...,DIGital15 FUNctIon MATH} for MSO models <n> ::= 1-2 or 1-4 in NR1 format <return_value> ::= time in seconds between the lower and upper thresholds in NR3 format
:MEASure:FREQuency [<source>] (see page 323)	:MEASure:FREQuency? [<source>] (see page 323)	<source> ::= {CHANnel<n> FUNctIon MATH} for DSO models <source> ::= {CHANnel<n> DIGital0,...,DIGital15 FUNctIon MATH} for MSO models <n> ::= 1-2 or 1-4 in NR1 format <return_value> ::= frequency in Hertz in NR3 format
:MEASure:NWIDth [<source>] (see page 324)	:MEASure:NWIDth? [<source>] (see page 324)	<source> ::= {CHANnel<n> FUNctIon MATH} for DSO models <source> ::= {CHANnel<n> DIGital0,...,DIGital15 FUNctIon MATH} for MSO models <n> ::= 1-2 or 1-4 in NR1 format <return_value> ::= negative pulse width in seconds-NR3 format
:MEASure:OVERshoot [<source>] (see page 325)	:MEASure:OVERshoot? [<source>] (see page 325)	<source> ::= {CHANnel<n> FUNctIon MATH} <n> ::= 1-2 or 1-4 in NR1 format <return_value> ::= the percent of the overshoot of the selected waveform in NR3 format
:MEASure:PERiod [<source>] (see page 327)	:MEASure:PERiod? [<source>] (see page 327)	<source> ::= {CHANnel<n> FUNctIon MATH} for DSO models <source> ::= {CHANnel<n> DIGital0,...,DIGital15 FUNctIon MATH} for MSO models <n> ::= 1-2 or 1-4 in NR1 format <return_value> ::= waveform period in seconds in NR3 format

Table 69 :MEASure Commands Summary (continued)

Command	Query	Options and Query Returns
:MEASure:PHASe [<source1>] [,<source2>] (see page 328)	:MEASure:PHASe? [<source1>] [,<source2>] (see page 328)	<source1,2> ::= {CHANnel<n> FUNctIon MATH} <n> ::= 1-2 or 1-4 in NR1 format <return_value> ::= the phase angle value in degrees in NR3 format
:MEASure:PREShoot [<source>] (see page 329)	:MEASure:PREShoot? [<source>] (see page 329)	<source> ::= {CHANnel<n> FUNctIon MATH} <n> ::= 1-2 or 1-4 in NR1 format <return_value> ::= the percent of preshoot of the selected waveform in NR3 format
:MEASure:PWIDth [<source>] (see page 330)	:MEASure:PWIDth? [<source>] (see page 330)	<source> ::= {CHANnel<n> FUNctIon MATH} for DSO models <source> ::= {CHANnel<n> DIGital0,..,DIGital15 FUNctIon MATH} for MSO models <n> ::= 1-2 or 1-4 in NR1 format <return_value> ::= width of positive pulse in seconds in NR3 format
n/a	:MEASure:RESults? <result_list> (see page 331)	<result_list> ::= comma-separated list of measurement results
:MEASure:RISetime [<source>] (see page 334)	:MEASure:RISetime? [<source>] (see page 334)	<source> ::= {CHANnel<n> FUNctIon MATH} <n> ::= 1-2 or 1-4 in NR1 format <return_value> ::= rise time in seconds in NR3 format
:MEASure:SDEVIation [<source>] (see page 335)	:MEASure:SDEVIation? [<source>] (see page 335)	<source> ::= {CHANnel<n> FUNctIon MATH} <n> ::= 1-2 or 1-4 in NR1 format <return_value> ::= calculated std deviation in NR3 format
:MEASure:SHOW {1 ON} (see page 336)	:MEASure:SHOW? (see page 336)	{1}

Table 69 :MEASure Commands Summary (continued)

Command	Query	Options and Query Returns
:MEASure:SOURce <source1> [,<source2>] (see page 337)	:MEASure:SOURce? (see page 337)	<source1,2> ::= {CHANnel<n> FUNctIon MATH EXtErnal} for DSO models <source1,2> ::= {CHANnel<n> DIGital0,..,DIGital15 FUNctIon MATH EXtErnal} for MSO models <n> ::= 1-2 or 1-4 in NR1 format <return_value> ::= {<source> NONE}
:MEASure:STATistics <type> (see page 339)	:MEASure:STATistics? (see page 339)	<type> ::= {{ON 1} CURRent MEAN MINimum MAXimum STDDev COUNT} ON ::= all statistics returned
:MEASure:STATistics:INCRement (see page 340)	n/a	n/a
:MEASure:STATistics:RESET (see page 341)	n/a	n/a
n/a	:MEASure:TEDGE? <slope><occurrence>[, <source>] (see page 342)	<slope> ::= direction of the waveform <occurrence> ::= the transition to be reported <source> ::= {CHANnel<n> FUNctIon MATH} for DSO models <source> ::= {CHANnel<n> DIGital0,..,DIGital15 FUNctIon MATH} for MSO models <n> ::= 1-2 or 1-4 in NR1 format <return_value> ::= time in seconds of the specified transition

Table 69 :MEASure Commands Summary (continued)

Command	Query	Options and Query Returns
n/a	:MEASure:TVALue? <value>, [<slope>]<occurrence> [,<source>] (see page 344)	<value> ::= voltage level that the waveform must cross. <slope> ::= direction of the waveform when <value> is crossed. <occurrence> ::= transitions reported. <return_value> ::= time in seconds of specified voltage crossing in NR3 format <source> ::= {CHANnel<n> FUNctIon MATH} for DSO models <source> ::= {CHANnel<n> DIGital0,...,DIGital15 FUNctIon MATH} for MSO models <n> ::= 1-2 or 1-4 in NR1 format
:MEASure:VAMPLitude [<source>] (see page 346)	:MEASure:VAMPLitude? [<source>] (see page 346)	<source> ::= {CHANnel<n> FUNctIon MATH} <n> ::= 1-2 or 1-4 in NR1 format <return_value> ::= the amplitude of the selected waveform in volts in NR3 format
:MEASure:VAverage [<source>] (see page 347)	:MEASure:VAverage? [<source>] (see page 347)	<source> ::= {CHANnel<n> FUNctIon MATH} <n> ::= 1-2 or 1-4 in NR1 format <return_value> ::= calculated average voltage in NR3 format
:MEASure:VBASe [<source>] (see page 348)	:MEASure:VBASe? [<source>] (see page 348)	<source> ::= {CHANnel<n> FUNctIon MATH} <n> ::= 1-2 or 1-4 in NR1 format <base_voltage> ::= voltage at the base of the selected waveform in NR3 format
:MEASure:VMAX [<source>] (see page 349)	:MEASure:VMAX? [<source>] (see page 349)	<source> ::= {CHANnel<n> FUNctIon MATH} <n> ::= 1-2 or 1-4 in NR1 format <return_value> ::= maximum voltage of the selected waveform in NR3 format
:MEASure:VMIN [<source>] (see page 350)	:MEASure:VMIN? [<source>] (see page 350)	<source> ::= {CHANnel<n> FUNctIon MATH} <n> ::= 1-2 or 1-4 in NR1 format <return_value> ::= minimum voltage of the selected waveform in NR3 format

Table 69 :MEASure Commands Summary (continued)

Command	Query	Options and Query Returns
:MEASure:VPP [<source>] (see page 351)	:MEASure:VPP? [<source>] (see page 351)	<source> ::= {CHANnel<n> FUNction MATH} <n> ::= 1-2 or 1-4 in NR1 format <return_value> ::= voltage peak-to-peak of the selected waveform in NR3 format
:MEASure:VRATio [<source1>] [,<source2>] (see page 328)	:MEASure:VRATio? [<source1>] [,<source2>] (see page 352)	<source1,2> ::= {CHANnel<n> FUNction MATH} <n> ::= 1-2 or 1-4 in NR1 format <return_value> ::= the ratio value in dB in NR3 format
:MEASure:VRMS [<source>] (see page 353)	:MEASure:VRMS? [<source>] (see page 353)	<source> ::= {CHANnel<n> FUNction MATH} <n> ::= 1-2 or 1-4 in NR1 format <return_value> ::= calculated dc RMS voltage in NR3 format
n/a	:MEASure:VTIME? <vtime>[,<source>] (see page 354)	<vtime> ::= displayed time from trigger in seconds in NR3 format <return_value> ::= voltage at the specified time in NR3 format <source> ::= {CHANnel<n> FUNction MATH} for DSO models <source> ::= {CHANnel<n> DIGital0,...,DIGital15 FUNction MATH} for MSO models <n> ::= 1-2 or 1-4 in NR1 format
:MEASure:VTOP [<source>] (see page 355)	:MEASure:VTOP? [<source>] (see page 355)	<source> ::= {CHANnel<n> FUNction MATH} <n> ::= 1-2 or 1-4 in NR1 format <return_value> ::= voltage at the top of the waveform in NR3 format
:MEASure:XMAX [<source>] (see page 356)	:MEASure:XMAX? [<source>] (see page 356)	<source> ::= {CHANnel<n> FUNction MATH} <n> ::= 1-2 or 1-4 in NR1 format <return_value> ::= horizontal value of the maximum in NR3 format
:MEASure:XMIN [<source>] (see page 357)	:MEASure:XMIN? [<source>] (see page 357)	<source> ::= {CHANnel<n> FUNction MATH} <n> ::= 1-2 or 1-4 in NR1 format <return_value> ::= horizontal value of the maximum in NR3 format

**Introduction to
:MEASure
Commands**

The commands in the MEASure subsystem are used to make parametric measurements on displayed waveforms.

Measurement Setup

To make a measurement, the portion of the waveform required for that measurement must be displayed on the oscilloscope screen.

Measurement Type	Portion of waveform that must be displayed
period, duty cycle, or frequency	at least one complete cycle
pulse width	the entire pulse
rise time	rising edge, top and bottom of pulse
fall time	falling edge, top and bottom of pulse

Measurement Error

If a measurement cannot be made (typically because the proper portion of the waveform is not displayed), the value +9.9E+37 is returned for that measurement.

Making Measurements

If more than one waveform, edge, or pulse is displayed, time measurements are made on the portion of the displayed waveform closest to the trigger reference (left, center, or right).

When making measurements in the zoomed (delayed) time base mode (:TIMEbase:MODE WINDOW), the oscilloscope will attempt to make the measurement inside the zoomed sweep window. If the measurement is an average and there are not three edges, the oscilloscope will revert to the mode of making the measurement at the start of the main sweep.

When the command form is used, the measurement result is displayed on the instrument. When the query form of these measurements is used, the measurement is made one time, and the measurement result is returned over the bus.

Measurements are made on the displayed waveforms specified by the :MEASure:SOURce command. The MATH source is an alias for the FUNCtion source.

Not all measurements are available on the digital channels or FFT (Fast Fourier Transform).

Reporting the Setup

Use the :MEASure? query to obtain setup information for the MEASure subsystem. (Currently, this is only :MEASure:SOURce.)

Return Format

The following is a sample response from the :MEASure? query. In this case, the query was issued following a *RST command.

```
:MEAS:SOUR CHAN1,CHAN2;STAT ON
```

:MEASure:CLEar

N (see [page 786](#))

Command Syntax :MEASure:CLEar

This command clears all selected measurements and markers from the screen.

See Also • ["Introduction to :MEASure Commands"](#) on page 312

:MEASure:COUNter

N (see [page 786](#))

Command Syntax :MEASure:COUNter [<source>]
 <source> ::= {<digital channels> | CHANnel<n> | EXTernal}
 <digital channels> ::= DIGital0,...,DIGital15 for the MSO models
 <n> ::= {1 | 2 | 3 | 4} for the four channel oscilloscope models
 <n> ::= {1 | 2} for the two channel oscilloscope models

The :MEASure:COUNter command installs a screen measurement and starts a counter measurement. If the optional source parameter is specified, the current source is modified. Any channel except Math may be selected for the source.

The counter measurement counts trigger level crossings at the selected trigger slope and displays the results in Hz. The gate time for the measurement is automatically adjusted to be 100 ms or twice the current time window, whichever is longer, up to 1 second. The counter measurement can measure frequencies up to 125 MHz. The minimum frequency supported is $1/(2 \times \text{gate time})$.

The Y cursor shows the the edge threshold level used in the measurement.

Only one counter measurement may be displayed at a time.

NOTE

This command is not available if the source is MATH.

Query Syntax :MEASure:COUNter? [<source>]

The :MEASure:COUNter? query measures and outputs the counter frequency of the specified source.

NOTE

The :MEASure:COUNter? query times out if the counter measurement is installed on the front panel. Use :MEASure:CLEar to remove the front-panel measurement before executing the :MEASure:COUNter? query.

Return Format <source><NL>

<source> ::= count in Hertz in NR3 format

- See Also**
- ["Introduction to :MEASure Commands"](#) on page 312
 - [":MEASure:SOURce"](#) on page 337
 - [":MEASure:FREQuency"](#) on page 323
 - [":MEASure:CLEar"](#) on page 314

:MEASure:DEFine

N (see page 786)

Command Syntax :MEASure:DEFine <meas_spec>

<meas_spec> ::= {DELay | THResholds}

The :MEASure:DEFine command sets up the definition for measurements by specifying the delta time or threshold values. Changing these values may affect the results of other measure commands. The table below identifies which measurement results that can be affected by redefining the DELay specification or the THResholds values. For example, changing the THResholds definition from the default 10%, 50%, and 90% values may change the returned measurement result.

MEASure Command	DELay	THResholds
DUTYcycle		x
DELay	x	x
FALLtime		x
FREQuency		x
NWIDth		x
OVERshoot		x
PERiod		x
PHASe		x
PREShoot		x
PWIDth		x
RISetime		x
VAVerage		x
VRMS		x

:MEASure:DEFine DELay Command Syntax :MEASure:DEFine DELay,<delay spec>

DELay Command Syntax

<delay spec> ::= <edge_spec1>,<edge_spec2>

<edge_spec1> ::= [<slope>]<occurrence>

<edge_spec2> ::= [<slope>]<occurrence>

<slope> ::= {+ | -}

<occurrence> ::= integer

This command defines the behavior of the :MEASure:DElay? query by specifying the start and stop edge to be used. <edge_spec1> specifies the slope and edge number on source1. <edge_spec2> specifies the slope and edge number on source2. The measurement is taken as:

$$\text{delay} = t(\text{<edge_spec2>}) - t(\text{<edge_spec1>})$$

NOTE

The :MEASure:DElay command and the front-panel delay measurement use an auto-edge selection method to determine the actual edge used for the measurement. The :MEASure:DEfine command has no effect on these delay measurements. The edges specified by the :MEASure:DEfine command only define the edges used by the :MEASure:DElay? query.

**:MEASure:DEfine
THResholds
Command Syntax**

```
:MEASure:DEfine THResholds,<threshold spec>
```

```
<threshold spec> ::= {STANdard  
| {<threshold mode>,<upper>,<middle>,<lower>}}
```

```
<threshold mode> ::= {PERCent | ABSolute}
```

for <threshold mode> = PERCent:

```
<upper>,<middle>,<lower> ::= A number specifying the upper, middle,  
and lower threshold percentage values  
between Vbase and Vtop in NR3 format.
```

for <threshold mode> = ABSolute:

```
<upper>,<middle>,<lower> ::= A number specifying the upper, middle,  
and lower threshold absolute values in  
NR3 format.
```

- STANdard threshold specification sets the lower, middle, and upper measurement thresholds to 10%, 50%, and 90% values between Vbase and Vtop.
- Threshold mode PERCent sets the measurement thresholds to any user-defined percentages between 5% and 95% of values between Vbase and Vtop.
- Threshold mode ABSolute sets the measurement thresholds to absolute values. ABSolute thresholds are dependent on channel scaling (:CHANnel<n>:RANGe or ":CHANnel<n>:SCALE" on page 234:CHANnel<n>:SCALE), probe attenuation (:CHANnel<n>:PROBe), and probe units (:CHANnel<n>:UNITs). Always set these values first before setting ABSolute thresholds.

Query Syntax

```
:MEASure:DEfine? <meas_spec>
```

```
<meas_spec> ::= {DElay | THResholds}
```

The :MEASure:DEfine? query returns the current edge specification for the delay measurements setup or the current specification for the thresholds setup.

Return Format for <meas_spec> = DELay:

```
{ <edge_spec1> | <edge_spec2> | <edge_spec1>,<edge_spec2>} <NL>
```

for <meas_spec> = THResholds and <threshold mode> = PERCent:

```
THR,PERC,<upper>,<middle>,<lower><NL>
```

<upper>, <middle>, <lower> ::= A number specifying the upper, middle, and lower threshold percentage values between Vbase and Vtop in NR3 format.

for <meas_spec> = THResholds and <threshold mode> = ABSolute:

```
THR,ABS,<upper>,<middle>,<lower><NL>
```

<upper>, <middle>, <lower> ::= A number specifying the upper, middle, and lower threshold voltages in NR3 format.

for <threshold spec> = STANdard:

```
THR,PERC,+90.0,+50.0,+10.0
```

- See Also**
- ["Introduction to :MEASure Commands"](#) on page 312
 - [":MEASure:DELay"](#) on page 319
 - [":MEASure:SOURce"](#) on page 337
 - [":CHANnel<n>:RANGe"](#) on page 233
 - [":CHANnel<n>:SCALE"](#) on page 234
 - [":CHANnel<n>:PROBE"](#) on page 227
 - [":CHANnel<n>:UNITs"](#) on page 235

:MEASure:DElay

N (see page 786)

Command Syntax :MEASure:DElay [<source1>][,<source2>]
 <source1>, <source2> ::= {CHANnel<n> | FUNction | MATH}
 <n> ::= {1 | 2 | 3 | 4} for the four channel oscilloscope models
 <n> ::= {1 | 2} for the two channel oscilloscope models

The :MEASure:DElay command places the instrument in the continuous measurement mode and starts a delay measurement.

The measurement is taken as:

$$\text{delay} = t(\text{<edge spec 2>}) - t(\text{<edge spec 1>})$$

where the <edge spec> definitions are set by the :MEASure:DEFine command

NOTE

The :MEASure:DElay command and the front-panel delay measurement differ from the :MEASure:DElay? query.

The delay command or front-panel measurement run the delay measurement in auto-edge select mode. In this mode, you can select the edge polarity, but the instrument will select the edges that will make the best possible delay measurement. The source1 edge chosen will be the edge that meets the polarity specified and is closest to the trigger reference point. The source2 edge selected will be that edge of the specified polarity that gives the first of the following criteria:

- The smallest positive delay value that is less than source1 period.
- The smallest negative delay that is less than source1 period.
- The smallest absolute value of delay.

The :MEASure:DElay? query will make the measurement using the edges specified by the :MEASure:DEFine command.

Query Syntax :MEASure:DElay? [<source1>][,<source2>]

The :MEASure:DElay? query measures and returns the delay between source1 and source2. The delay measurement is made from the user-defined slope and edge count of the signal connected to source1, to the defined slope and edge count of the signal connected to source2. Delay measurement slope and edge parameters are selected using the :MEASure:DEFine command.

Also in the :MEASure:DEFine command, you can set upper, middle, and lower threshold values. *It is the middle threshold value that is used when performing the delay query.* The standard upper, middle, and lower measurement thresholds are 90%, 50%, and 10% values between Vbase and

5 Commands by Subsystem

Vtop. If you want to move the delay measurement point nearer to Vtop or Vbase, you must change the threshold values with the :MEASure:DEFine THResholds command.

Return Format <value><NL>

<value> ::= floating-point number delay time in seconds in NR3 format

- See Also**
- ["Introduction to :MEASure Commands"](#) on page 312
 - [":MEASure:DEFine"](#) on page 316
 - [":MEASure:PHASe"](#) on page 328

:MEASure:DUTYcycle

C (see [page 786](#))

Command Syntax :MEASure:DUTYcycle [<source>]
 <source> ::= {<digital channels> | CHANnel<n> | FUNction | MATH}
 <digital channels> ::= DIGital0,...,DIGital15 for the MSO models
 <n> ::= {1 | 2 | 3 | 4} for the four channel oscilloscope models
 <n> ::= {1 | 2} for the two channel oscilloscope models

The :MEASure:DUTYcycle command installs a screen measurement and starts a duty cycle measurement on the current :MEASure:SOURce. If the optional source parameter is specified, the current source is modified.

NOTE

The signal must be displayed to make the measurement. This command is not available if the source is FFT (Fast Fourier Transform).

Query Syntax :MEASure:DUTYcycle? [<source>]

The :MEASure:DUTYcycle? query measures and outputs the duty cycle of the signal specified by the :MEASure:SOURce command. The value returned for the duty cycle is the ratio of the positive pulse width to the period. The positive pulse width and the period of the specified signal are measured, then the duty cycle is calculated with the following formula:

$$\text{duty cycle} = (\text{pulse width}/\text{period}) * 100$$

Return Format <value><NL>
 <value> ::= ratio of positive pulse width to period in NR3 format

- See Also**
- "[Introduction to :MEASure Commands](#)" on page 312
 - "[:MEASure:PERiod](#)" on page 327
 - "[:MEASure:PWIDth](#)" on page 330
 - "[:MEASure:SOURce](#)" on page 337

Example Code

- "[Example Code](#)" on page 338

:MEASure:FALLtime

C (see [page 786](#))

Command Syntax :MEASure:FALLtime [<source>]

<source> ::= {CHANnel<n> | FUNCTION | MATH}

<n> ::= {1 | 2 | 3 | 4} for the four channel oscilloscope models

<n> ::= {1 | 2} for the two channel oscilloscope models

The :MEASure:FALLtime command installs a screen measurement and starts a fall-time measurement. For highest measurement accuracy, set the sweep speed as fast as possible, while leaving the falling edge of the waveform on the display. If the optional source parameter is specified, the current source is modified.

NOTE

This command is not available if the source is FFT (Fast Fourier Transform).

Query Syntax :MEASure:FALLtime? [<source>]

The :MEASure:FALLtime? query measures and outputs the fall time of the displayed falling (negative-going) edge closest to the trigger reference. The fall time is determined by measuring the time at the upper threshold of the falling edge, then measuring the time at the lower threshold of the falling edge, and calculating the fall time with the following formula:

$$\text{fall time} = \text{time at lower threshold} - \text{time at upper threshold}$$

Return Format <value><NL>

<value> ::= time in seconds between the lower threshold and upper threshold in NR3 format

- See Also**
- "[Introduction to :MEASure Commands](#)" on page 312
 - "[:MEASure:RISetime](#)" on page 334
 - "[:MEASure:SOURce](#)" on page 337

:MEASure:FREQuency

C (see [page 786](#))

Command Syntax :MEASure:FREQuency [<source>]
 <source> ::= {<digital channels> | CHANnel<n> | FUNction | MATH}
 <digital channels> ::= DIGital0,...,DIGital15 for the MSO models
 <n> ::= {1 | 2 | 3 | 4} for the four channel oscilloscope models
 <n> ::= {1 | 2} for the two channel oscilloscope models

The :MEASure:FREQuency command installs a screen measurement and starts a frequency measurement. If the optional source parameter is specified, the current source is modified.

IF the edge on the screen closest to the trigger reference is rising:

THEN frequency = 1/(time at trailing rising edge - time at leading rising edge)

ELSE frequency = 1/(time at trailing falling edge - time at leading falling edge)

NOTE

This command is not available if the source is FFT (Fast Fourier Transform).

Query Syntax :MEASure:FREQuency? [<source>]

The :MEASure:FREQuency? query measures and outputs the frequency of the cycle on the screen closest to the trigger reference.

Return Format <source><NL>

<source> ::= frequency in Hertz in NR3 format

- See Also**
- ["Introduction to :MEASure Commands"](#) on page 312
 - [":MEASure:SOURce"](#) on page 337
 - [":MEASure:PERiod"](#) on page 327

Example Code • ["Example Code"](#) on page 338

:MEASure:NWIDth

C (see [page 786](#))

Command Syntax :MEASure:NWIDth [<source>]
 <source> ::= {<digital channels> | CHANnel<n> | FUNction | MATH}
 <digital channels> ::= DIGital0,...,DIGital15 for the MSO models
 <n> ::= {1 | 2 | 3 | 4} for the four channel oscilloscope models
 <n> ::= {1 | 2} for the two channel oscilloscope models

The :MEASure:NWIDth command installs a screen measurement and starts a negative pulse width measurement. If the optional source parameter is specified, the current source is modified.

NOTE

This command is not available if the source is FFT (Fast Fourier Transform).

Query Syntax :MEASure:NWIDth? [<source>]

The :MEASure:NWIDth? query measures and outputs the width of the negative pulse on the screen closest to the trigger reference using the midpoint between the upper and lower thresholds.

FOR the negative pulse closest to the trigger point:

$$\text{width} = (\text{time at trailing rising edge} - \text{time at leading falling edge})$$

Return Format <value><NL>
 <value> ::= negative pulse width in seconds in NR3 format

- See Also**
- ["Introduction to :MEASure Commands"](#) on page 312
 - [":MEASure:SOURce"](#) on page 337
 - [":MEASure:PWIDth"](#) on page 330
 - [":MEASure:PERiod"](#) on page 327

:MEASure:OVERshoot

C (see page 786)

Command Syntax :MEASure:OVERshoot [<source>]

<source> ::= {CHANnel<n> | FUNCTION | MATH}

<n> ::= {1 | 2 | 3 | 4} for the four channel oscilloscope models

<n> ::= {1 | 2} for the two channel oscilloscope models

The :MEASure:OVERshoot command installs a screen measurement and starts an overshoot measurement. If the optional source parameter is specified, the current source is modified.

NOTE

This command is not available if the source is FFT (Fast Fourier Transform).

Query Syntax :MEASure:OVERshoot? [<source>]

The :MEASure:OVERshoot? query measures and returns the overshoot of the edge closest to the trigger reference, displayed on the screen. The method used to determine overshoot is to make three different vertical value measurements: Vtop, Vbase, and either Vmax or Vmin, depending on whether the edge is rising or falling.

For a rising edge:

$$\text{overshoot} = ((V_{\text{max}} - V_{\text{top}}) / (V_{\text{top}} - V_{\text{base}})) \times 100$$

For a falling edge:

$$\text{overshoot} = ((V_{\text{base}} - V_{\text{min}}) / (V_{\text{top}} - V_{\text{base}})) \times 100$$

Vtop and Vbase are taken from the normal histogram of all waveform vertical values. The extremum of Vmax or Vmin is taken from the waveform interval right after the chosen edge, halfway to the next edge. This more restricted definition is used instead of the normal one, because it is conceivable that a signal may have more preshoot than overshoot, and the normal extremum would then be dominated by the preshoot of the following edge.

Return Format <overshoot><NL>

<overshoot> ::= the percent of the overshoot of the selected waveform in NR3 format

- See Also**
- "Introduction to :MEASure Commands" on page 312
 - ":MEASure:PREShoot" on page 329
 - ":MEASure:SOURce" on page 337
 - ":MEASure:VMAX" on page 349

5 Commands by Subsystem

- `":MEASure:VTOP"` on page 355
- `":MEASure:VBASe"` on page 348
- `":MEASure:VMIN"` on page 350

:MEASure:PERiod

C (see [page 786](#))

Command Syntax :MEASure:PERiod [<source>]
 <source> ::= {<digital channels> | CHANnel<n> | FUNction | MATH}
 <digital channels> ::= DIGital0,...,DIGital15 for the MSO models
 <n> ::= {1 | 2 | 3 | 4} for the four channel oscilloscope models
 <n> ::= {1 | 2} for the two channel oscilloscope models

The :MEASure:PERiod command installs a screen measurement and starts the period measurement. If the optional source parameter is specified, the current source is modified.

NOTE

This command is not available if the source is FFT (Fast Fourier Transform).

Query Syntax :MEASure:PERiod? [<source>]

The :MEASure:PERiod? query measures and outputs the period of the cycle closest to the trigger reference on the screen. The period is measured at the midpoint of the upper and lower thresholds.

IF the edge closest to the trigger reference on screen is rising:

THEN period = (time at trailing rising edge - time at leading rising edge)

ELSE period = (time at trailing falling edge - time at leading falling edge)

Return Format <value><NL>
 <value> ::= waveform period in seconds in NR3 format

- See Also**
- ["Introduction to :MEASure Commands"](#) on page 312
 - [":MEASure:SOURce"](#) on page 337
 - [":MEASure:NWIDTH"](#) on page 324
 - [":MEASure:PWIDTh"](#) on page 330
 - [":MEASure:FREQuency"](#) on page 323

Example Code • ["Example Code"](#) on page 338

:MEASure:PHASe

N (see [page 786](#))

Command Syntax :MEASure:PHASe [<source1>][,<source2>]
 <source1>, <source2> ::= {CHANnel<n> | FUNction | MATH}
 <n> ::= {1 | 2 | 3 | 4} for the four channel oscilloscope models
 <n> ::= {1 | 2} for the two channel oscilloscope models

The :MEASure:PHASe command places the instrument in the continuous measurement mode and starts a phase measurement.

Query Syntax :MEASure:PHASe? [<source1>][,<source2>]

The :MEASure:PHASe? query measures and returns the phase between the specified sources.

A phase measurement is a combination of the period and delay measurements. First, the period is measured on source1. Then the delay is measured between source1 and source2. The edges used for delay are the source1 rising edge used for the period measurement closest to the horizontal reference and the rising edge on source 2. See :MEASure:DELAy for more detail on selecting the 2nd edge.

The phase is calculated as follows:

$$\text{phase} = (\text{delay} / \text{period of input 1}) \times 360$$

Return Format <value><NL>
 <value> ::= the phase angle value in degrees in NR3 format

- See Also**
- ["Introduction to :MEASure Commands"](#) on page 312
 - [":MEASure:DELAy"](#) on page 319
 - [":MEASure:PERiod"](#) on page 327
 - [":MEASure:SOURce"](#) on page 337

:MEASure:PREShoot

C (see [page 786](#))

Command Syntax :MEASure:PREShoot [<source>]

<source> ::= {CHANnel<n> | FUNCTION | MATH}

<n> ::= {1 | 2 | 3 | 4} for the four channel oscilloscope models

<n> ::= {1 | 2} for the two channel oscilloscope models

The :MEASure:PREShoot command installs a screen measurement and starts a preshoot measurement. If the optional source parameter is specified, the current source is modified.

Query Syntax :MEASure:PREShoot? [<source>]

The :MEASure:PREShoot? query measures and returns the preshoot of the edge closest to the trigger, displayed on the screen. The method used to determine preshoot is to make three different vertical value measurements: Vtop, Vbase, and either Vmin or Vmax, depending on whether the edge is rising or falling.

For a rising edge:

$$\text{preshoot} = ((V_{\text{min}} - V_{\text{base}}) / (V_{\text{top}} - V_{\text{base}})) \times 100$$

For a falling edge:

$$\text{preshoot} = ((V_{\text{max}} - V_{\text{top}}) / (V_{\text{top}} - V_{\text{base}})) \times 100$$

Vtop and Vbase are taken from the normal histogram of all waveform vertical values. The extremum of Vmax or Vmin is taken from the waveform interval right before the chosen edge, halfway back to the previous edge. This more restricted definition is used instead of the normal one, because it is likely that a signal may have more overshoot than preshoot, and the normal extremum would then be dominated by the overshoot of the preceding edge.

Return Format <value><NL>

<value> ::= the percent of preshoot of the selected waveform
in NR3 format

- See Also**
- ["Introduction to :MEASure Commands"](#) on page 312
 - [":MEASure:SOURce"](#) on page 337
 - [":MEASure:VMIN"](#) on page 350
 - [":MEASure:VMAX"](#) on page 349
 - [":MEASure:VTOP"](#) on page 355
 - [":MEASure:VBASe"](#) on page 348

:MEASure:PWIDth

C (see [page 786](#))

Command Syntax :MEASure:PWIDth [<source>]
 <source> ::= {<digital channels> | CHANnel<n> | FUNction | MATH}
 <digital channels> ::= DIGital0,...,DIGital15 for the MSO models
 <n> ::= {1 | 2 | 3 | 4} for the four channel oscilloscope models
 <n> ::= {1 | 2} for the two channel oscilloscope models

The :MEASure:PWIDth command installs a screen measurement and starts the positive pulse width measurement. If the optional source parameter is specified, the current source is modified.

NOTE

This command is not available if the source is FFT (Fast Fourier Transform).

Query Syntax :MEASure:PWIDth? [<source>]

The :MEASure:PWIDth? query measures and outputs the width of the displayed positive pulse closest to the trigger reference. Pulse width is measured at the midpoint of the upper and lower thresholds.

IF the edge on the screen closest to the trigger is falling:

THEN width = (time at trailing falling edge - time at leading rising edge)

ELSE width = (time at leading falling edge - time at leading rising edge)

Return Format <value><NL>
 <value> ::= width of positive pulse in seconds in NR3 format

- See Also**
- ["Introduction to :MEASure Commands"](#) on page 312
 - [":MEASure:SOURce"](#) on page 337
 - [":MEASure:NWIDth"](#) on page 324
 - [":MEASure:PERiod"](#) on page 327

:MEASure:RESults

N (see [page 786](#))

Query Syntax :MEASure:RESults?

The :MEASure:RESults? query returns the results of the continuously displayed measurements. The response to the MEASure:RESults? query is a list of comma-separated values.

If more than one measurement is running continuously, the :MEASure:RESults return values are duplicated for each continuous measurement from the first to last (left to right) result displayed. Each result returned is separated from the previous result by a comma. There is a maximum of four continuous measurements that can be continuously displayed at a time.

When no quick measurements are installed, the :MEASure:RESults? query returns nothing (empty string). When the count for any of the measurements is 0, the value of infinity (9.9E+37) is returned for the min, max, mean, and standard deviation.

Return Format <result_list><NL>

<result_list> ::= comma-separated list of measurement results

The following shows the order of values received for a single measurement if :MEASure:STATistics is set to ON.

Measurement label	current	min	max	mean	std dev	count
-------------------	---------	-----	-----	------	---------	-------

Measurement label, current, min, max, mean, std dev, and count are only returned if :MEASure:STATistics is ON.

If :MEASure:STATistics is set to CURRENT, MIN, MAX, MEAN, STDDev, or COUNT only that particular statistic value is returned for each measurement that is on.

- See Also**
- ["Introduction to :MEASure Commands"](#) on page 312
 - [":MEASure:STATistics"](#) on page 339

Example Code

```
' This program shows the InfiniiVision oscilloscopes' measurement
' statistics commands.
' -----
```

```
Option Explicit
```

```
Public myMgr As VisaComLib.ResourceManager
Public myScope As VisaComLib.FormattedIO488
Public varQueryResult As Variant
Public strQueryResult As String
```

5 Commands by Subsystem

```
Private Declare Sub Sleep Lib "kernel32" (ByVal dwMilliseconds As Long)

Sub Main()

    On Error GoTo VisaComError

    ' Create the VISA COM I/O resource.
    Set myMgr = New VisaComLib.ResourceManager
    Set myScope = New VisaComLib.FormattedIO488
    Set myScope.IO = myMgr.Open("TCPIP0::130.29.70.228::inst0::INSTR")

    ' Initialize.
    myScope.IO.Clear ' Clear the interface.
    myScope.WriteString "*RST" ' Reset to the defaults.
    myScope.WriteString "*CLS" ' Clear the status data structures.
    myScope.WriteString ":AUToscale"

    ' Install some measurements.
    myScope.WriteString ":MEASure:SOURce CHANnel1" ' Input source.

    Dim MeasurementArray(3) As String
    MeasurementArray(0) = "FREQuency"
    MeasurementArray(1) = "DUTYcycle"
    MeasurementArray(2) = "VAMPLitude"
    MeasurementArray(3) = "VPP"
    Dim Measurement As Variant

    For Each Measurement In MeasurementArray
        myScope.WriteString ":MEASure:" + Measurement
        myScope.WriteString ":MEASure:" + Measurement + "?"
        varQueryResult = myScope.ReadNumber ' Read measurement value.
        Debug.Print Measurement + ": " + FormatNumber(varQueryResult, 4)
    Next

    myScope.WriteString ":MEASure:STATistics:RESet" ' Reset stats.
    Sleep 5000 ' Wait for 5 seconds.

    ' Select the statistics results type.
    Dim ResultsTypeArray(6) As String
    ResultsTypeArray(0) = "CURRent"
    ResultsTypeArray(1) = "MINimum"
    ResultsTypeArray(2) = "MAXimum"
    ResultsTypeArray(3) = "MEAN"
    ResultsTypeArray(4) = "STDDev"
    ResultsTypeArray(5) = "COUNT"
    ResultsTypeArray(6) = "ON" ' All results.
    Dim ResultType As Variant

    Dim ResultsList()

    Dim ValueColumnArray(6) As String
    ValueColumnArray(0) = "Meas_Lbl"
    ValueColumnArray(1) = "Current"
    ValueColumnArray(2) = "Min"
    ValueColumnArray(3) = "Max"
    ValueColumnArray(4) = "Mean"
```

```

ValueColumnArray(5) = "Std_Dev"
ValueColumnArray(6) = "Count"
Dim ValueColumn As Variant

For Each ResultType In ResultsTypeArray
    myScope.WriteString ":MEASure:STATistics " + ResultType

    ' Get the statistics results.
    Dim intCounter As Integer
    intCounter = 0
    myScope.WriteString ":MEASure:RESults?"
    ResultsList() = myScope.ReadList

    For Each Measurement In MeasurementArray

        If ResultType = "ON" Then ' All statistics.

            For Each ValueColumn In ValueColumnArray
                If VarType(ResultsList(intCounter)) <> vbString Then
                    Debug.Print "Measure statistics result CH1, " + _
                        Measurement + ", "; ValueColumn + ": " + _
                        FormatNumber(ResultsList(intCounter), 4)

                Else ' Result is a string (e.g., measurement label).
                    Debug.Print "Measure statistics result CH1, " + _
                        Measurement + ", "; ValueColumn + ": " + _
                        ResultsList(intCounter)

                End If

                intCounter = intCounter + 1

            Next

        Else ' Specific statistic (e.g., Current, Max, Min, etc.).

            Debug.Print "Measure statistics result CH1, " + _
                Measurement + ", "; ResultType + ": " + _
                FormatNumber(ResultsList(intCounter), 4)

            intCounter = intCounter + 1

        End If

    Next

Next

Exit Sub

VisaComError:
    MsgBox "VISA COM Error:" + vbCrLf + Err.Description

End Sub

```

:MEASure:RISetime

C (see [page 786](#))

Command Syntax :MEASure: RISetime [<source>]

<source> ::= {CHANnel<n> | FUNction | MATH}

<n> ::= {1 | 2 | 3 | 4} for the four channel oscilloscope models

<n> ::= {1 | 2} for the two channel oscilloscope models

The :MEASure:RISetime command installs a screen measurement and starts a rise-time measurement. If the optional source parameter is specified, the current source is modified.

NOTE

This command is not available if the source is FFT (Fast Fourier Transform).

Query Syntax :MEASure: RISetime? [<source>]

The :MEASure:RISetime? query measures and outputs the rise time of the displayed rising (positive-going) edge closest to the trigger reference. For maximum measurement accuracy, set the sweep speed as fast as possible while leaving the leading edge of the waveform on the display. The rise time is determined by measuring the time at the lower threshold of the rising edge and the time at the upper threshold of the rising edge, then calculating the rise time with the following formula:

$$\text{rise time} = \text{time at upper threshold} - \text{time at lower threshold}$$

Return Format <value><NL>

<value> ::= rise time in seconds in NR3 format

- See Also**
- ["Introduction to :MEASure Commands"](#) on page 312
 - [":MEASure:SOURce"](#) on page 337
 - [":MEASure:FALLtime"](#) on page 322

:MEASure:SDEVIation

N (see [page 786](#))

Command Syntax :MEASure:SDEVIation [<source>]

<source> ::= {CHANnel<n> | FUNction | MATH}

<n> ::= {1 | 2 | 3 | 4} for the four channel oscilloscope models

<n> ::= {1 | 2} for the two channel oscilloscope models

The :MEASure:SDEVIation command installs a screen measurement and starts std deviation measurement. If the optional source parameter is specified, the current source is modified.

NOTE

This command is not available if the source is FFT (Fast Fourier Transform).

Query Syntax :MEASure:SDEVIation? [<source>]

The :MEASure:SDEVIation? query measures and outputs the std deviation of the selected waveform. The oscilloscope computes the std deviation on all displayed data points.

Return Format <value><NL>

<value> ::= calculated std deviation value in NR3 format

- See Also**
- ["Introduction to :MEASure Commands"](#) on page 312
 - [":MEASure:SOURce"](#) on page 337

:MEASure:SHOW

N (see [page 786](#))

Command Syntax :MEASure:SHOW <show>
<show> ::= {1 | ON}

The :MEASure:SHOW command enables markers for tracking measurements on the display. This feature is always on.

Query Syntax :MEASure:SHOW?

The :MEASure:SHOW? query returns the current state of the markers.

Return Format <show><NL>
<show> ::= 1

See Also • ["Introduction to :MEASure Commands"](#) on page 312

:MEASure:SOURce

C (see [page 786](#))

Command Syntax :MEASure:SOURce <source1>[,<source2>]

<source1>,<source2> ::= {<digital channels> | CHANnel<n> | FUNCtion
| MATH | EXTernal}

<digital channels> ::= DIGital0,...,DIGital15 for the MSO models

<n> ::= {1 | 2 | 3 | 4} for the four channel oscilloscope models

<n> ::= {1 | 2} for the two channel oscilloscope models

The :MEASure:SOURce command sets the default sources for measurements. The specified sources are used as the sources for the MEASure subsystem commands if the sources are not explicitly set with the command.

If a source is specified for any measurement, the current source is changed to this new value.

If :MARKer:MODE is set to OFF or MANual, setting :MEASure:SOURce to CHANnel<n>, FUNCtion, or MATH will also set :MARKer:X1Y1source to source1 and :MARKer:X2Y2source to source2.

EXTernal is only a valid source for the counter measurement (and <source1>).

Query Syntax :MEASure:SOURce?

The :MEASure:SOURce? query returns the current source selections. If source2 is not specified, the query returns "NONE" for source2. If all channels are off, the query returns "NONE,NONE". Source2 only applies to :MEASure:DELAy and :MEASure:PHASe measurements.

NOTE

MATH is an alias for FUNCtion. The query will return FUNC if the source is FUNCtion or MATH.

Return Format <source1>,<source2><NL>

<source1>,<source2> ::= {<digital channels> | CHAN<n> | FUNC | EXT
| NONE}

- See Also:**
- ["Introduction to :MEASure Commands"](#) on page 312
 - [":MARKer:MODE"](#) on page 297
 - [":MARKer:X1Y1source"](#) on page 299
 - [":MARKer:X2Y2source"](#) on page 301
 - [":MEASure:DELAy"](#) on page 319
 - [":MEASure:PHASe"](#) on page 328

Example Code

```
' MEASURE - The commands in the MEASURE subsystem are used to make
' measurements on displayed waveforms.
myScope.WriteString ":MEASURE:SOURCE CHANNEL1" ' Source to measure.
myScope.WriteString ":MEASURE:FREQUENCY?" ' Query for frequency.
varQueryResult = myScope.ReadNumber ' Read frequency.
MsgBox "Frequency:" + vbCrLf _
    + FormatNumber(varQueryResult / 1000, 4) + " kHz"
myScope.WriteString ":MEASURE:DUTYCYCLE?" ' Query for duty cycle.
varQueryResult = myScope.ReadNumber ' Read duty cycle.
MsgBox "Duty cycle:" + vbCrLf _
    + FormatNumber(varQueryResult, 3) + "%"
myScope.WriteString ":MEASURE:RISETIME?" ' Query for risetime.
varQueryResult = myScope.ReadNumber ' Read risetime.
MsgBox "Risetime:" + vbCrLf _
    + FormatNumber(varQueryResult * 1000000, 4) + " us"
myScope.WriteString ":MEASURE:VPP?" ' Query for Pk to Pk voltage.
varQueryResult = myScope.ReadNumber ' Read VPP.
MsgBox "Peak to peak voltage:" + vbCrLf _
    + FormatNumber(varQueryResult, 4) + " V"
myScope.WriteString ":MEASURE:VMAX?" ' Query for Vmax.
varQueryResult = myScope.ReadNumber ' Read Vmax.
MsgBox "Maximum voltage:" + vbCrLf _
    + FormatNumber(varQueryResult, 4) + " V"
```

Example program from the start: ["VISA COM Example in Visual Basic"](#) on page 812

:MEASure:STATistics

N (see [page 786](#))

Command Syntax :MEASure:STATistics <type>

```
<type> ::= {{ON | 1} | CURRent | MINimum | MAXimum | MEAN | STDev
           | COUNT}
```

The :MEASure:STATistics command determines the type of information returned by the :MEASure:RESults? query. ON means all the statistics are on.

Query Syntax :MEASure:STATistics?

The :MEASure:STATistics? query returns the current statistics mode.

Return Format <type><NL>

```
<type> ::= {ON | CURR | MIN | MAX | MEAN | STDD | COUN}
```

- See Also**
- ["Introduction to :MEASure Commands"](#) on page 312
 - [":MEASure:RESults"](#) on page 331
 - [":MEASure:STATistics:RESet"](#) on page 341
 - [":MEASure:STATistics:INCRement"](#) on page 340

Example Code • ["Example Code"](#) on page 331

:MEASure:STATistics:INCRement

N (see [page 786](#))

Command Syntax :MEASure:STATistics:INCRement

This command updates the statistics once (incrementing the count by one) using the current measurement values. It corresponds to the front panel **Increment Statistics** softkey in the Measurement Statistics Menu. This command lets you, for example, gather statistics over multiple pulses captured in a single acquisition. To do this, change the horizontal position and enter the command for each new pulse that is measured.

This command is only allowed when the oscilloscope is stopped and quick measurements are on.

The command is allowed in segmented acquisition mode even though the corresponding front panel softkey is not available.

- See Also**
- ["Introduction to :MEASure Commands"](#) on page 312
 - [":MEASure:STATistics"](#) on page 339
 - [":MEASure:STATistics:RESet"](#) on page 341
 - [":MEASure:RESults"](#) on page 331

:MEASure:STATistics:RESet

N (see [page 786](#))

Command Syntax :MEASure:STATistics:RESet

This command resets the measurement statistics, zeroing the counts.

Note that the measurement (statistics) configuration is not deleted.

- See Also**
- ["Introduction to :MEASure Commands"](#) on page 312
 - [":MEASure:STATistics"](#) on page 339
 - [":MEASure:RESults"](#) on page 331
 - [":MEASure:STATistics:INCRement"](#) on page 340

- Example Code**
- ["Example Code"](#) on page 331

:MEASure:TEDGe

N (see [page 786](#))

Query Syntax :MEASure:TEDGe? <slope><occurrence>[,<source>]

<slope> ::= direction of the waveform. A rising slope is indicated by a space or plus sign (+). A falling edge is indicated by a minus sign (-).

<occurrence> ::= the transition to be reported. If the occurrence number is one, the first crossing from the left screen edge is reported. If the number is two, the second crossing is reported, etc.

<source> ::= {<digital channels> | CHANnel<n> | FUNction | MATH}

<digital channels> ::= DIGital0,...,DIGital15 for the MSO models

<n> ::= {1 | 2 | 3 | 4} for the four channel oscilloscope models

<n> ::= {1 | 2} for the two channel oscilloscope models

When the :MEASure:TEDGe query is sent, the displayed signal is searched for the specified transition. The time interval between the trigger event and this occurrence is returned as the response to the query. The sign of the slope selects a rising (+) or falling (-) edge. If no sign is specified for the slope, it is assumed to be the rising edge.

The magnitude of occurrence defines the occurrence to be reported. For example, +3 returns the time for the third time the waveform crosses the midpoint threshold in the positive direction. Once this crossing is found, the oscilloscope reports the time at that crossing in seconds, with the trigger point (time zero) as the reference.

If the specified crossing cannot be found, the oscilloscope reports +9.9E+37. This value is returned if the waveform does not cross the specified vertical value, or if the waveform does not cross the specified vertical value for the specific number of times in the direction specified.

You can make delay and phase measurements using the MEASure:TEDGe command:

Delay = time at the nth rising or falling edge of the channel - time at the same edge of another channel

Phase = (delay between channels / period of channel) x 360

For an example of making a delay and phase measurement, see "[:MEASure:TEDGe Code](#)" on page 343.

If the optional source parameter is specified, the current source is modified.

NOTE

This query is not available if the source is FFT (Fast Fourier Transform).

Return Format

<value><NL>

<value> ::= time in seconds of the specified transition in NR3 format

**:MEASure:TEDGe
Code**

```
' Make a delay measurement between channel 1 and 2.
Dim dblChan1Edge1 As Double
Dim dblChan2Edge1 As Double
Dim dblChan1Edge2 As Double
Dim dblDelay As Double
Dim dblPeriod As Double
Dim dblPhase As Double

' Query time at 1st rising edge on ch1.
myScope.WriteString ":MEASURE:TEDGE? +1, CHAN1"

' Read time at edge 1 on ch 1.
dblChan1Edge1 = myScope.ReadNumber

' Query time at 1st rising edge on ch2.
myScope.WriteString ":MEASURE:TEDGE? +1, CHAN2"

' Read time at edge 1 on ch 2.
dblChan2Edge1 = myScope.ReadNumber

' Calculate delay time between ch1 and ch2.
dblDelay = dblChan2Edge1 - dblChan1Edge1

' Write calculated delay time to screen.
MsgBox "Delay = " + vbCrLf + CStr(dblDelay)

' Make a phase difference measurement between channel 1 and 2.
' Query time at 1st rising edge on ch1.
myScope.WriteString ":MEASURE:TEDGE? +2, CHAN1"

' Read time at edge 2 on ch 1.
dblChan1Edge2 = myScope.ReadNumber

' Calculate period of ch 1.
dblPeriod = dblChan1Edge2 - dblChan1Edge1

' Calculate phase difference between ch1 and ch2.
dblPhase = (dblDelay / dblPeriod) * 360
MsgBox "Phase = " + vbCrLf + CStr(dblPhase)
```

Example program from the start: ["VISA COM Example in Visual Basic"](#) on page 812

- See Also**
- ["Introduction to :MEASure Commands"](#) on page 312
 - [":MEASure:TVALue"](#) on page 344
 - [":MEASure:VTIME"](#) on page 354

:MEASure:TVALue

C (see [page 786](#))

Query Syntax :MEASure:TVALue? <value>, [<slope>]<occurrence>[,<source>]

<value> ::= the vertical value that the waveform must cross. The value can be volts or a math function value such as dB, Vs, or V/s.

<slope> ::= direction of the waveform. A rising slope is indicated by a plus sign (+). A falling edge is indicated by a minus sign (-).

<occurrence> ::= the transition to be reported. If the occurrence number is one, the first crossing is reported. If the number is two, the second crossing is reported, etc.

<source> ::= {CHANnel<n> | FUNCTION | MATH}

<n> ::= {1 | 2 | 3 | 4} for the four channel oscilloscope models

<n> ::= {1 | 2} for the two channel oscilloscope models

When the :MEASure:TVALue? query is sent, the displayed signal is searched for the specified value level and transition. The time interval between the trigger event and this defined occurrence is returned as the response to the query.

The specified value can be negative or positive. To specify a negative value, use a minus sign (-). The sign of the slope selects a rising (+) or falling (-) edge. If no sign is specified for the slope, it is assumed to be the rising edge.

The magnitude of the occurrence defines the occurrence to be reported. For example, +3 returns the time for the third time the waveform crosses the specified value level in the positive direction. Once this value crossing is found, the oscilloscope reports the time at that crossing in seconds, with the trigger point (time zero) as the reference.

If the specified crossing cannot be found, the oscilloscope reports +9.9E+37. This value is returned if the waveform does not cross the specified value, or if the waveform does not cross the specified value for the specified number of times in the direction specified.

If the optional source parameter is specified, the current source is modified.

NOTE

This query is not available if the source is FFT (Fast Fourier Transform).

Return Format <value><NL>

<value> ::= time in seconds of the specified value crossing in
NR3 format

- See Also**
- ["Introduction to :MEASure Commands"](#) on page 312
 - [":MEASure:TEDGE"](#) on page 342
 - [":MEASure:VTIME"](#) on page 354

:MEASure:VAMPlitude

C (see [page 786](#))

Command Syntax :MEASure:VAMPlitude [<source>]

<source> ::= {CHANnel<n> | FUNCTION | MATH}

<n> ::= {1 | 2 | 3 | 4} for the four channel oscilloscope models

<n> ::= {1 | 2} for the two channel oscilloscope models

The :MEASure:VAMPlitude command installs a screen measurement and starts a vertical amplitude measurement. If the optional source parameter is specified, the current source is modified.

Query Syntax :MEASure:VAMPlitude? [<source>]

The :MEASure:VAMPlitude? query measures and returns the vertical amplitude of the waveform. To determine the amplitude, the instrument measures Vtop and Vbase, then calculates the amplitude as follows:

$$\text{vertical amplitude} = V_{\text{top}} - V_{\text{base}}$$

Return Format <value><NL>

<value> ::= the amplitude of the selected waveform in NR3 format

- See Also**
- ["Introduction to :MEASure Commands"](#) on page 312
 - [":MEASure:SOURce"](#) on page 337
 - [":MEASure:VBASe"](#) on page 348
 - [":MEASure:VTOP"](#) on page 355
 - [":MEASure:VPP"](#) on page 351

:MEASure:VAverage

C (see [page 786](#))

Command Syntax :MEASure:VAverage [<source>]

<source> ::= {CHANnel<n> | FUNCTION | MATH}

<n> ::= {1 | 2 | 3 | 4} for the four channel oscilloscope models

<n> ::= {1 | 2} for the two channel oscilloscope models

The :MEASure:VAverage command installs a screen measurement and starts an average value measurement. If the optional source parameter is specified, the current source is modified.

Query Syntax :MEASure:VAverage? [<source>]

The :MEASure:VAverage? query returns the average value of an integral number of periods of the signal. If at least three edges are not present, the oscilloscope averages all data points.

Return Format <value><NL>

<value> ::= calculated average value in NR3 format

- See Also**
- ["Introduction to :MEASure Commands"](#) on page 312
 - [":MEASure:SOURce"](#) on page 337

:MEASure:VBASe

C (see [page 786](#))

Command Syntax :MEASure:VBASe [<source>]

<source> ::= {CHANnel<n> | FUNCTION | MATH}

<n> ::= {1 | 2 | 3 | 4} for the four channel oscilloscope models

<n> ::= {1 | 2} for the two channel oscilloscope models

The :MEASure:VBASe command installs a screen measurement and starts a waveform base value measurement. If the optional source parameter is specified, the current source is modified.

NOTE

This command is not available if the source is FFT (Fast Fourier Transform).

Query Syntax :MEASure:VBASe? [<source>]

The :MEASure:VBASe? query returns the vertical value at the base of the waveform. The base value of a pulse is normally not the same as the minimum value.

Return Format <base_voltage><NL>

<base_voltage> ::= value at the base of the selected waveform in NR3 format

- See Also**
- ["Introduction to :MEASure Commands"](#) on page 312
 - [":MEASure:SOURce"](#) on page 337
 - [":MEASure:VTOP"](#) on page 355
 - [":MEASure:VAMPLitude"](#) on page 346
 - [":MEASure:VMIN"](#) on page 350

:MEASure:VMAX

C (see [page 786](#))

Command Syntax :MEASure:VMAX [<source>]

<source> ::= {CHANnel<n> | FUNCTION | MATH}

<n> ::= {1 | 2 | 3 | 4} for the four channel oscilloscope models

<n> ::= {1 | 2} for the two channel oscilloscope models

The :MEASure:VMAX command installs a screen measurement and starts a maximum vertical value measurement. If the optional source parameter is specified, the current source is modified.

Query Syntax :MEASure:VMAX? [<source>]

The :MEASure:VMAX? query measures and outputs the maximum vertical value present on the selected waveform.

Return Format <value><NL>

<value> ::= maximum vertical value of the selected waveform in NR3 format

- See Also**
- ["Introduction to :MEASure Commands"](#) on page 312
 - [":MEASure:SOURce"](#) on page 337
 - [":MEASure:VMIN"](#) on page 350
 - [":MEASure:VPP"](#) on page 351
 - [":MEASure:VTOP"](#) on page 355

:MEASure:VMIN

C (see [page 786](#))

Command Syntax :MEASure:VMIN [<source>]

<source> ::= {CHANnel<n> | FUNction | MATH}

<n> ::= {1 | 2 | 3 | 4} for the four channel oscilloscope models

<n> ::= {1 | 2} for the two channel oscilloscope models

The :MEASure:VMIN command installs a screen measurement and starts a minimum vertical value measurement. If the optional source parameter is specified, the current source is modified.

Query Syntax :MEASure:VMIN? [<source>]

The :MEASure:VMIN? query measures and outputs the minimum vertical value present on the selected waveform.

Return Format <value><NL>

<value> ::= minimum vertical value of the selected waveform in NR3 format

- See Also**
- ["Introduction to :MEASure Commands"](#) on page 312
 - [":MEASure:SOURce"](#) on page 337
 - [":MEASure:VBASe"](#) on page 348
 - [":MEASure:VMAX"](#) on page 349
 - [":MEASure:VPP"](#) on page 351

:MEASure:VPP

C (see [page 786](#))

Command Syntax :MEASure:VPP [<source>]

<source> ::= {CHANnel<n> | FUNCTION | MATH}

<n> ::= {1 | 2 | 3 | 4} for the four channel oscilloscope models

<n> ::= {1 | 2} for the two channel oscilloscope models

The :MEASure:VPP command installs a screen measurement and starts a vertical peak-to-peak measurement. If the optional source parameter is specified, the current source is modified.

Query Syntax :MEASure:VPP? [<source>]

The :MEASure:VPP? query measures the maximum and minimum vertical value for the selected source, then calculates the vertical peak-to-peak value and returns that value. The peak-to-peak value (Vpp) is calculated with the following formula:

$$V_{pp} = V_{max} - V_{min}$$

Vmax and Vmin are the vertical maximum and minimum values present on the selected source.

Return Format <value><NL>

<value> ::= vertical peak to peak value in NR3 format

- See Also**
- ["Introduction to :MEASure Commands"](#) on page 312
 - [":MEASure:SOURce"](#) on page 337
 - [":MEASure:VMAX"](#) on page 349
 - [":MEASure:VMIN"](#) on page 350
 - [":MEASure:VAMPLitude"](#) on page 346

:MEASure:VRATio

N (see [page 786](#))

Command Syntax :MEASure:VRATio [<source1>][,<source2>]

<source1>, <source2> ::= {CHANnel<n> | FUNction | MATH}

<n> ::= {1 | 2 | 3 | 4} for the four channel oscilloscope models

<n> ::= {1 | 2} for the two channel oscilloscope models

The :MEASure:VRATio command places the instrument in the continuous measurement mode and starts a ratio measurement.

Query Syntax :MEASure:VRATio? [<source1>][,<source2>]

The :MEASure:VRATio? query measures and returns the ratio of AC RMS values of the specified sources expressed as dB.

Return Format <value><NL>

<value> ::= the ratio value in dB in NR3 format

- See Also**
- ["Introduction to :MEASure Commands"](#) on page 312
 - [":MEASure:VRMS"](#) on page 353
 - [":MEASure:SOURce"](#) on page 337

:MEASure:VRMS

C (see [page 786](#))

Command Syntax :MEASure:VRMS [<source>]

<source> ::= {CHANnel<n> | FUNCtion | MATH}

<n> ::= {1 | 2 | 3 | 4} for the four channel oscilloscope models

<n> ::= {1 | 2} for the two channel oscilloscope models

The :MEASure:VRMS command installs a screen measurement and starts a dc RMS value measurement. If the optional source parameter is specified, the current source is modified.

NOTE

This command is not available if the source is FFT (Fast Fourier Transform).

Query Syntax :MEASure:VRMS? [<source>]

The :MEASure:VRMS? query measures and outputs the dc RMS value of the selected waveform. The dc RMS value is measured on an integral number of periods of the displayed signal. If at least three edges are not present, the oscilloscope computes the RMS value on all displayed data points.

Return Format <value><NL>

<value> ::= calculated dc RMS value in NR3 format

- See Also**
- "[Introduction to :MEASure Commands](#)" on page 312
 - "[:MEASure:SOURce](#)" on page 337

:MEASure:VTIME

N (see [page 786](#))

Query Syntax :MEASure:VTIME? <vtime_argument>[,<source>]
 <vtime_argument> ::= time from trigger in seconds
 <source> ::= {<digital channels> | CHANnel<n> | FUNction | MATH}
 <digital channels> ::= DIGital0,...,DIGital15 for the MSO models
 <n> ::= {1 | 2 | 3 | 4} for the four channel oscilloscope models
 <n> ::= {1 | 2} for the two channel oscilloscope models

The :MEASure:VTIME? query returns the value at a specified time on the source specified with :MEASure:SOURce. The specified time must be on the screen and is referenced to the trigger event. If the optional source parameter is specified, the current source is modified.

NOTE

This query is not available if the source is FFT (Fast Fourier Transform).

Return Format <value><NL>
 <value> ::= value at the specified time in NR3 format

- See Also**
- ["Introduction to :MEASure Commands"](#) on page 312
 - [":MEASure:SOURce"](#) on page 337
 - [":MEASure:TEDGe"](#) on page 342
 - [":MEASure:TVALue"](#) on page 344

:MEASure:VTOP

C (see [page 786](#))

Command Syntax :MEASure:VTOP [<source>]

<source> ::= {CHANnel<n> | FUNCTION | MATH}

<n> ::= {1 | 2 | 3 | 4} for the four channel oscilloscope models

<n> ::= {1 | 2} for the two channel oscilloscope models

The :MEASure:VTOP command installs a screen measurement and starts a waveform top value measurement.

NOTE

This query is not available if the source is FFT (Fast Fourier Transform).

Query Syntax :MEASure:VTOP? [<source>]

The :MEASure:VTOP? query returns the vertical value at the top of the waveform. The top value of the pulse is normally not the same as the maximum value.

Return Format <value><NL>

<value> ::= vertical value at the top of the waveform in NR3 format

- See Also**
- ["Introduction to :MEASure Commands"](#) on page 312
 - [":MEASure:SOURce"](#) on page 337
 - [":MEASure:VMAX"](#) on page 349
 - [":MEASure:VAMPLitude"](#) on page 346
 - [":MEASure:VBASe"](#) on page 348

:MEASure:XMAX

N (see [page 786](#))

Command Syntax :MEASure:XMAX [<source>]

<source> ::= {CHANnel<n> | FUNCTION | MATH}

<n> ::= {1 | 2 | 3 | 4} for the four channel oscilloscope models

<n> ::= {1 | 2} for the two channel oscilloscope models

The :MEASure:XMAX command installs a screen measurement and starts an X-at-Max-Y measurement on the selected window. If the optional source parameter is specified, the current source is modified.

NOTE

:MEASure:XMAX is an alias for :MEASure:TMAX.

Query Syntax :MEASure:XMAX? [<source>]

The :MEASure:XMAX? query measures and returns the horizontal axis value at which the maximum vertical value occurs. If the optional source is specified, the current source is modified. If all channels are off, the query returns 9.9E+37.

Return Format <value><NL>

<value> ::= horizontal value of the maximum in NR3 format

- See Also**
- ["Introduction to :MEASure Commands"](#) on page 312
 - [":MEASure:XMIN"](#) on page 357
 - [":MEASure:TMAX"](#) on page 717

:MEASure:XMIn

N (see [page 786](#))

Command Syntax :MEASure:XMIn [<source>]

<source> ::= {CHANnel<n> | FUNction | MATH}

<n> ::= {1 | 2 | 3 | 4} for the four channel oscilloscope models

<n> ::= {1 | 2} for the two channel oscilloscope models

The :MEASure:XMIn command installs a screen measurement and starts an X-at-Min-Y measurement on the selected window. If the optional source parameter is specified, the current source is modified.

NOTE

:MEASure:XMIn is an alias for :MEASure:TMin.

Query Syntax :MEASure:XMIn? [<source>]

The :MEASure:XMIn? query measures and returns the horizontal axis value at which the minimum vertical value occurs. If the optional source is specified, the current source is modified. If all channels are off, the query returns 9.9E+37.

Return Format <value><NL>

<value> ::= horizontal value of the minimum in NR3 format

- See Also**
- ["Introduction to :MEASure Commands"](#) on page 312
 - [":MEASure:XMAX"](#) on page 356
 - [":MEASure:TMin"](#) on page 718

:MTESt Commands

The MTESt subsystem commands and queries control the mask test features. See "[Introduction to :MTESt Commands](#)" on page 360.

Table 70 :MTESt Commands Summary

Command	Query	Options and Query Returns
:MTESt:AMASk:CREate (see page 363)	n/a	n/a
:MTESt:AMASk:SOURce <source> (see page 364)	:MTESt:AMASk:SOURce? (see page 364)	<source> ::= CHANnel<n> <n> ::= {1 2 3 4} for 4ch models <n> ::= {1 2} for 2ch models
:MTESt:AMASk:UNITs <units> (see page 365)	:MTESt:AMASk:UNITs? (see page 365)	<units> ::= {CURRent DIVisions}
:MTESt:AMASk:XDELta <value> (see page 366)	:MTESt:AMASk:XDELta? (see page 366)	<value> ::= X delta value in NR3 format
:MTESt:AMASk:YDELta <value> (see page 367)	:MTESt:AMASk:YDELta? (see page 367)	<value> ::= Y delta value in NR3 format
n/a	:MTESt:COUNt:FwAVeformS? [CHANnel<n>] (see page 368)	<failed> ::= number of failed waveforms in NR1 format
:MTESt:COUNt:RESet (see page 369)	n/a	n/a
n/a	:MTESt:COUNt:TIME? (see page 370)	<time> ::= elapsed seconds in NR3 format
n/a	:MTESt:COUNt:WAVEformS? (see page 371)	<count> ::= number of waveforms in NR1 format
:MTESt:DATA <mask> (see page 372)	:MTESt:DATA? (see page 372)	<mask> ::= data in IEEE 488.2 # format.
:MTESt:DELeTe (see page 373)	n/a	n/a
:MTESt:ENABle {{0 OFF} {1 ON}} (see page 374)	:MTESt:ENABle? (see page 374)	{0 1}
:MTESt:LOCK {{0 OFF} {1 ON}} (see page 375)	:MTESt:LOCK? (see page 375)	{0 1}

Table 70 :MTESt Commands Summary (continued)

Command	Query	Options and Query Returns
:MTESt:OUTPut <signal> (see page 376)	:MTESt:OUTPut? (see page 376)	<signal> ::= {FAIL PASS}
:MTESt:RMODE <rmode> (see page 377)	:MTESt:RMODE? (see page 377)	<rmode> ::= {FORever TIME SIGMa WAVEforms}
:MTESt:RMODE:FACTION: MEASure {{0 OFF} {1 ON}} (see page 378)	:MTESt:RMODE:FACTION: MEASure? (see page 378)	{0 1}
:MTESt:RMODE:FACTION: PRINt {{0 OFF} {1 ON}} (see page 379)	:MTESt:RMODE:FACTION: PRINt? (see page 379)	{0 1}
:MTESt:RMODE:FACTION: SAVE {{0 OFF} {1 ON}} (see page 380)	:MTESt:RMODE:FACTION: SAVE? (see page 380)	{0 1}
:MTESt:RMODE:FACTION: STOP {{0 OFF} {1 ON}} (see page 381)	:MTESt:RMODE:FACTION: STOP? (see page 381)	{0 1}
:MTESt:RMODE:SIGMa <level> (see page 382)	:MTESt:RMODE:SIGMa? (see page 382)	<level> ::= from 0.1 to 9.3 in NR3 format
:MTESt:RMODE:TIME <seconds> (see page 383)	:MTESt:RMODE:TIME? (see page 383)	<seconds> ::= from 1 to 86400 in NR3 format
:MTESt:RMODE:WAVEform s <count> (see page 384)	:MTESt:RMODE:WAVEform s? (see page 384)	<count> ::= number of waveforms in NR1 format
:MTESt:SCALE:BIND {{0 OFF} {1 ON}} (see page 385)	:MTESt:SCALE:BIND? (see page 385)	{0 1}
:MTESt:SCALE:X1 <x1_value> (see page 386)	:MTESt:SCALE:X1? (see page 386)	<x1_value> ::= X1 value in NR3 format
:MTESt:SCALE:XDELta <xdelta_value> (see page 387)	:MTESt:SCALE:XDELta? (see page 387)	<xdelta_value> ::= X delta value in NR3 format
:MTESt:SCALE:Y1 <y1_value> (see page 388)	:MTESt:SCALE:Y1? (see page 388)	<y1_value> ::= Y1 value in NR3 format

Table 70 :MTESt Commands Summary (continued)

Command	Query	Options and Query Returns
:MTESt:SCALe:Y2 <y2_value> (see page 389)	:MTESt:SCALe:Y2? (see page 389)	<y2_value> ::= Y2 value in NR3 format
:MTESt:SOURce <source> (see page 390)	:MTESt:SOURce? (see page 390)	<source> ::= {CHANnel<n> NONE} <n> ::= {1 2 3 4} for 4ch models <n> ::= {1 2} for 2ch models
n/a	:MTESt:TITLe? (see page 391)	<title> ::= a string of up to 128 ASCII characters

**Introduction to
:MTESt
Commands**

Mask testing automatically compares the current displayed waveform with the boundaries of a set of polygons that you define. Any waveform or sample that falls within the boundaries of one or more polygons is recorded as a failure.

Reporting the Setup

Use :MTESt? to query setup information for the MTESt subsystem.

Return Format

The following is a sample response from the :MTESt? query. In this case, the query was issued following a *RST command.

```
:MTES:SOUR CHAN1;ENAB 0;LOCK 1;:MTES:AMAS:SOUR CHAN1;UNIT DIV;XDEL
+2.50000000E-001;YDEL +2.50000000E-001;:MTES:SCAL:X1 +200.000E-06;XDEL
+400.000E-06;Y1 -3.00000E+00;Y2 +3.00000E+00;BIND 0;:MTES:RMOD
FOR;RMOD:TIME +1E+00;WAV 1000;SIGM +6.0E+00;:MTES:RMOD:FACT:STOP
0;PRIN 0;SAVE 0
```

Example Code

```
' Mask testing commands example.
' -----

Option Explicit

Public myMgr As VisaComLib.ResourceManager
Public myScope As VisaComLib.FormattedIO488
Public varQueryResult As Variant
Public strQueryResult As String

Private Declare Sub Sleep Lib "kernel32" (ByVal dwMilliseconds As Long)

Sub Main()

    On Error GoTo VisaComError

    ' Create the VISA COM I/O resource.
```



```

Set myMgr = New VisaComLib.ResourceManager
Set myScope = New VisaComLib.FormattedIO488
Set myScope.IO = myMgr.Open("TCPIP0::130.29.70.228::inst0::INSTR")
myScope.IO.Clear ' Clear the interface.

' Make sure oscilloscope is running.
myScope.WriteString ":RUN"

' Set mask test termination conditions.
myScope.WriteString ":MTESt:RMODE SIGMa"
myScope.WriteString ":MTESt:RMODE?"
strQueryResult = myScope.ReadString
Debug.Print "Mask test termination mode: " + strQueryResult

myScope.WriteString ":MTESt:RMODE:SIGMa 4.2"
myScope.WriteString ":MTESt:RMODE:SIGMa?"
varQueryResult = myScope.ReadNumber
Debug.Print "Mask test termination 'test sigma': " + _
    FormatNumber(varQueryResult)

' Use auto-mask to create mask.
myScope.WriteString ":MTESt:AMASk:SOURce CHANnel1"
myScope.WriteString ":MTESt:AMASk:SOURce?"
strQueryResult = myScope.ReadString
Debug.Print "Mask test auto-mask source: " + strQueryResult

myScope.WriteString ":MTESt:AMASk:UNITs DIVisions"
myScope.WriteString ":MTESt:AMASk:UNITs?"
strQueryResult = myScope.ReadString
Debug.Print "Mask test auto-mask units: " + strQueryResult

myScope.WriteString ":MTESt:AMASk:XDELta 0.1"
myScope.WriteString ":MTESt:AMASk:XDELta?"
varQueryResult = myScope.ReadNumber
Debug.Print "Mask test auto-mask X delta: " + _
    FormatNumber(varQueryResult)

myScope.WriteString ":MTESt:AMASk:YDELta 0.1"
myScope.WriteString ":MTESt:AMASk:YDELta?"
varQueryResult = myScope.ReadNumber
Debug.Print "Mask test auto-mask Y delta: " + _
    FormatNumber(varQueryResult)

' Enable "Auto Mask Created" event (bit 10, &H400)
myScope.WriteString "*CLS"
myScope.WriteString ":MTEenable " + CStr(CInt("&H400"))

' Create mask.
myScope.WriteString ":MTESt:AMASk:CREate"
Debug.Print "Auto-mask created, mask test automatically enabled."

' Set up timeout variables.
Dim lngTimeout As Long ' Max millisecs to wait.
Dim lngElapsed As Long
lngTimeout = 60000 ' 60 seconds.

' Wait until mask is created.

```

5 Commands by Subsystem

```
lngElapsed = 0
Do While lngElapsed <= lngTimeout
    myScope.WriteString ":OPERRegister:CONDition?"
    varQueryResult = myScope.ReadNumber
    ' Operation Status Condition Register MTE bit (bit 9, &H200).
    If (varQueryResult And &H200) <> 0 Then
        Exit Do
    Else
        Sleep 100 ' Small wait to prevent excessive queries.
        lngElapsed = lngElapsed + 100
    End If
Loop

' Look for RUN bit = stopped (mask test termination).
lngElapsed = 0
Do While lngElapsed <= lngTimeout
    myScope.WriteString ":OPERRegister:CONDition?"
    varQueryResult = myScope.ReadNumber
    ' Operation Status Condition Register RUN bit (bit 3, &H8).
    If (varQueryResult And &H8) = 0 Then
        Exit Do
    Else
        Sleep 100 ' Small wait to prevent excessive queries.
        lngElapsed = lngElapsed + 100
    End If
Loop

' Get total waveforms, failed waveforms, and test time.
myScope.WriteString ":MTESt:COUNT:WAVEforms?"
strQueryResult = myScope.ReadString
Debug.Print "Mask test total waveforms: " + strQueryResult

myScope.WriteString ":MTESt:COUNT:FWAVEforms?"
strQueryResult = myScope.ReadString
Debug.Print "Mask test failed waveforms: " + strQueryResult

myScope.WriteString ":MTESt:COUNT:TIME?"
strQueryResult = myScope.ReadString
Debug.Print "Mask test elapsed seconds: " + strQueryResult

Exit Sub

VisaComError:
    MsgBox "VISA COM Error:" + vbCrLf + Err.Description

End Sub
```

:MTESt:AMASk:CREate

N (see [page 786](#))

Command Syntax :MTESt:AMASk:CREate

The :MTESt:AMASk:CREate command automatically constructs a mask around the current selected channel, using the tolerance parameters defined by the :MTESt:AMASk:XDELta, :MTESt:AMASk:YDELta, and :MTESt:AMASk:UNITs commands. The mask only encompasses the portion of the waveform visible on the display, so you must ensure that the waveform is acquired and displayed consistently to obtain repeatable results.

The :MTESt:SOURce command selects the channel and should be set before using this command.

- See Also**
- "[Introduction to :MTESt Commands](#)" on page 360
 - "[:MTESt:AMASk:XDELta](#)" on page 366
 - "[:MTESt:AMASk:YDELta](#)" on page 367
 - "[:MTESt:AMASk:UNITs](#)" on page 365
 - "[:MTESt:AMASk:SOURce](#)" on page 364
 - "[:MTESt:SOURce](#)" on page 390

- Example Code**
- "[Example Code](#)" on page 360

:MTESt:AMASk:SOURce

N (see [page 786](#))

Command Syntax :MTESt:AMASk:SOURce <source>

<source> ::= CHANnel<n>

<n> ::= {1 | 2 | 3 | 4} for the four channel oscilloscope models

<n> ::= {1 | 2} for the two channel oscilloscope models

The :MTESt:AMASk:SOURce command selects the source for the interpretation of the :MTESt:AMASk:XDELta and :MTESt:AMASk:YDELta parameters when :MTESt:AMASk:UNITs is set to CURRent.

When UNITs are CURRent, the XDELta and YDELta parameters are defined in terms of the channel units, as set by the :CHANnel<n>:UNITs command, of the selected source.

Suppose that UNITs are CURRent and that you set SOURce to CHANNEL1, which is using units of volts. Then you can define AMASk:XDELta in terms of volts and AMASk:YDELta in terms of seconds.

This command is the same as the :MTESt:SOURce command.

Query Syntax :MTESt:AMASk:SOURce?

The :MTESt:AMASk:SOURce? query returns the currently set source.

Return Format <source> ::= CHAN<n>

<n> ::= {1 | 2 | 3 | 4} for the four channel oscilloscope models

<n> ::= {1 | 2} for the two channel oscilloscope models

- See Also**
- ["Introduction to :MTESt Commands"](#) on page 360
 - [":MTESt:AMASk:XDELta"](#) on page 366
 - [":MTESt:AMASk:YDELta"](#) on page 367
 - [":MTESt:AMASk:UNITs"](#) on page 365
 - [":MTESt:SOURce"](#) on page 390

Example Code • ["Example Code"](#) on page 360

:MTESt:AMASk:UNITs

N (see [page 786](#))

Command Syntax :MTESt:AMASk:UNITs <units>
 <units> ::= {CURRent | DIVisions}

The :MTESt:AMASk:UNITs command alters the way the mask test subsystem interprets the tolerance parameters for automasking as defined by :MTESt:AMASk:XDELta and :MTESt:AMASk:YDELta commands.

- CURRent – the mask test subsystem uses the units as set by the :CHANnel<n>:UNITs command, usually time for ΔX and voltage for ΔY .
- DIVisions – the mask test subsystem uses the graticule as the measurement system, so tolerance settings are specified as parts of a screen division. The mask test subsystem maintains separate XDELta and YDELta settings for CURRent and DIVisions. Thus, XDELta and YDELta are not converted to new values when the UNITs setting is changed.

Query Syntax :MTESt:AMASk:UNITs?

The :MTESt:AMASk:UNITs query returns the current measurement units setting for the mask test automask feature.

Return Format <units><NL>
 <units> ::= {CURR | DIV}

- See Also**
- ["Introduction to :MTESt Commands"](#) on page 360
 - [":MTESt:AMASk:XDELta"](#) on page 366
 - [":MTESt:AMASk:YDELta"](#) on page 367
 - [":CHANnel<n>:UNITs"](#) on page 235
 - [":MTESt:AMASk:SOURce"](#) on page 364
 - [":MTESt:SOURce"](#) on page 390

Example Code • ["Example Code"](#) on page 360

:MTESt:AMASk:XDELta

N (see [page 786](#))

Command Syntax :MTESt:AMASk:XDELta <value>
 <value> ::= X delta value in NR3 format

The :MTESt:AMASk:XDELta command sets the tolerance in the X direction around the waveform for the automasking feature. The absolute value of the tolerance will be added and subtracted to horizontal values of the waveform to determine the boundaries of the mask.

The horizontal tolerance value is interpreted based on the setting specified by the :MTESt:AMASk:UNITs command; thus, if you specify 250-E3, the setting for :MTESt:AMASk:UNITs is CURRent, and the current setting specifies time in the horizontal direction, the tolerance will be ± 250 ms. If the setting for :MTESt:AMASk:UNITs is DIVisions, the same X delta value will set the tolerance to ± 250 millidivisions, or 1/4 of a division.

Query Syntax :MTESt:AMASk:XDELta?

The :MTESt:AMASk:XDELta? query returns the current setting of the ΔX tolerance for automasking. If your computer program will interpret this value, it should also request the current measurement system using the :MTESt:AMASk:UNITs query.

Return Format <value><NL>
 <value> ::= X delta value in NR3 format

- See Also**
- "[Introduction to :MTESt Commands](#)" on page 360
 - "[:MTESt:AMASk:UNITs](#)" on page 365
 - "[:MTESt:AMASk:YDELta](#)" on page 367
 - "[:MTESt:AMASk:SOURce](#)" on page 364
 - "[:MTESt:SOURce](#)" on page 390

- Example Code**
- "[Example Code](#)" on page 360

:MTESt:AMASk:YDELta

N (see [page 786](#))

Command Syntax :MTESt:AMASk:YDELta <value>
 <value> ::= Y delta value in NR3 format

The :MTESt:AMASk:YDELta command sets the vertical tolerance around the waveform for the automasking feature. The absolute value of the tolerance will be added and subtracted to vertical values of the waveform to determine the boundaries of the mask.

The vertical tolerance value is interpreted based on the setting specified by the :MTESt:AMASk:UNITs command; thus, if you specify 250-E3, the setting for :MTESt:AMASk:UNITs is CURREnt, and the current setting specifies voltage in the vertical direction, the tolerance will be ± 250 mV. If the setting for :MTESt:AMASk:UNITs is DIVisions, the same Y delta value will set the tolerance to ± 250 millidivisions, or 1/4 of a division.

Query Syntax :MTESt:AMASk:YDELta?

The :MTESt:AMASk:YDELta? query returns the current setting of the ΔY tolerance for automasking. If your computer program will interpret this value, it should also request the current measurement system using the :MTESt:AMASk:UNITs query.

Return Format <value><NL>
 <value> ::= Y delta value in NR3 format

- See Also**
- "[Introduction to :MTESt Commands](#)" on page 360
 - "[:MTESt:AMASk:UNITs](#)" on page 365
 - "[:MTESt:AMASk:XDELta](#)" on page 366
 - "[:MTESt:AMASk:SOURce](#)" on page 364
 - "[:MTESt:SOURce](#)" on page 390

- Example Code**
- "[Example Code](#)" on page 360

:MTESt:COUNT:FWAVEforms

N (see [page 786](#))

Query Syntax :MTESt:COUNT:FWAVEforms? [CHANnel<n>]

<n> ::= {1 | 2 | 3 | 4} for the four channel oscilloscope models

<n> ::= {1 | 2} for the two channel oscilloscope models

The :MTESt:COUNT:FWAVEforms? query returns the total number of failed waveforms in the current mask test run. This count is for all regions and all waveforms.

Return Format <failed><NL>

<failed> ::= number of failed waveforms in NR1 format.

- See Also**
- "[Introduction to :MTESt Commands](#)" on page 360
 - "[:MTESt:COUNT:WAVEforms](#)" on page 371
 - "[:MTESt:COUNT:TIME](#)" on page 370
 - "[:MTESt:COUNT:RESet](#)" on page 369
 - "[:MTESt:SOURce](#)" on page 390

Example Code • "[Example Code](#)" on page 360

:MTESt:COUNT:RESet**N** (see [page 786](#))**Command Syntax** :MTESt:COUNT:RESet

The :MTESt:COUNT:RESet command resets the mask statistics.

- See Also**
- ["Introduction to :MTESt Commands"](#) on page 360
 - [":MTESt:COUNT:WAVEforms"](#) on page 371
 - [":MTESt:COUNT:FWAVEforms"](#) on page 368
 - [":MTESt:COUNT:TIME"](#) on page 370

:MTEST:COUNT:TIME

N (see [page 786](#))

Query Syntax :MTEST:COUNT:TIME?

The :MTEST:COUNT:TIME? query returns the elapsed time in the current mask test run.

Return Format <time><NL>

<time> ::= elapsed seconds in NR3 format.

- See Also**
- ["Introduction to :MTEST Commands"](#) on page 360
 - [":MTEST:COUNT:WAVEforms"](#) on page 371
 - [":MTEST:COUNT:FWAVEforms"](#) on page 368
 - [":MTEST:COUNT:RESet"](#) on page 369

Example Code • ["Example Code"](#) on page 360

:MTESt:COUNT:WAVEforms

N (see [page 786](#))

Query Syntax :MTESt:COUNT:WAVEforms?

The :MTESt:COUNT:WAVEforms? query returns the total number of waveforms acquired in the current mask test run.

Return Format <count><NL>

<count> ::= number of waveforms in NR1 format.

- See Also**
- ["Introduction to :MTESt Commands"](#) on page 360
 - [":MTESt:COUNT:FWAVEforms"](#) on page 368
 - [":MTESt:COUNT:TIME"](#) on page 370
 - [":MTESt:COUNT:RESEt"](#) on page 369

Example Code • ["Example Code"](#) on page 360

:MTEST:DATA

N (see [page 786](#))

Command Syntax :MTEST:DATA <mask>

<mask> ::= binary block data in IEEE 488.2 # format.

The :MTEST:DATA command loads a mask from binary block data.

Query Syntax :MTEST:DATA?

The :MTEST:DATA? query returns a mask in binary block data format. The format for the data transmission is the # format defined in the IEEE 488.2 specification.

Return Format <mask><NL>

<mask> ::= binary block data in IEEE 488.2 # format

- See Also**
- [":SAVE:MASK\[:START\]"](#) on [page 413](#)
 - [":RECall:MASK\[:START\]"](#) on [page 400](#)

:MTESt:DELeTe

N (see [page 786](#))

Command Syntax :MTESt:DELeTe

The :MTESt:DELeTe command clears the currently loaded mask.

- See Also**
- ["Introduction to :MTESt Commands"](#) on page 360
 - [":MTESt:AMASk:CREate"](#) on page 363

:MTESt:ENABle

N (see [page 786](#))

Command Syntax :MTESt:ENABle <on_off>

<on_off> ::= {{1 | ON} | {0 | OFF}}

The :MTESt:ENABle command enables or disables the mask test features.

- ON – Enables the mask test features.
- OFF – Disables the mask test features.

Query Syntax :MTESt:ENABle?

The :MTESt:ENABle? query returns the current state of mask test features.

Return Format <on_off><NL>

<on_off> ::= {1 | 0}

See Also • ["Introduction to :MTESt Commands"](#) on page 360

:MTEST:LOCK

N (see [page 786](#))

Command Syntax :MTEST:LOCK <on_off>
 <on_off> ::= {{1 | ON} | {0 | OFF}}

The :MTEST:LOCK command enables or disables the mask lock feature:

- ON – Locks a mask to the SOURCE. As the vertical or horizontal scaling or position of the SOURCE changes, the mask is redrawn accordingly.
- OFF – The mask is static and does not move.

Query Syntax :MTEST:LOCK?

The :MTEST:LOCK? query returns the current mask lock setting.

Return Format <on_off><NL>
 <on_off> ::= {1 | 0}

- See Also**
- "[Introduction to :MTEST Commands](#)" on page 360
 - "[:MTEST:SOURCE](#)" on page 390

:MTESt:OUTPut

N (see [page 786](#))

Command Syntax :MTESt:OUTPut <signal>
<signal> ::= {FAIL | PASS}

The :MTESt:OUTPut command selects the mask test output condition:

- FAIL – the output occurs when there are mask test failures.
- PASS – the output occurs when the mask test passes.

You can place the mask test signal on the rear panel TRIG OUT BNC using the [":CALibrate:OUTPut"](#) on [page 211](#) command.

Query Syntax :MTESt:OUTPut?

The :MTESt:OUTPut? query returns the currently set output signal.

Return Format <signal><NL>
<signal> ::= {FAIL | PASS}

- See Also**
- ["Introduction to :MTESt Commands"](#) on [page 360](#)
 - [":CALibrate:OUTPut"](#) on [page 211](#)

:MTESt:RMODe

N (see [page 786](#))

Command Syntax :MTESt:RMODe <rmode>
 <rmode> ::= {FORever | SIGMa | TIME | WAVeforms}

The :MTESt:RMODe command specifies the termination conditions for the mask test:

- FORever – the mask test runs until it is turned off.
- SIGMa – the mask test runs until the Sigma level is reached. This level is set by the [":MTESt:RMODe:SIGMa"](#) on page 382 command.
- TIME – the mask test runs for a fixed amount of time. The amount of time is set by the [":MTESt:RMODe:TIME"](#) on page 383 command.
- WAVeforms – the mask test runs until a fixed number of waveforms are acquired. The number of waveforms is set by the [":MTESt:RMODe:WAVeforms"](#) on page 384 command.

Query Syntax :MTESt:RMODe?

The :MTESt:RMODe? query returns the currently set termination condition.

Return Format <rmode><NL>
 <rmode> ::= {FOR | SIGM | TIME | WAV}

- See Also**
- ["Introduction to :MTESt Commands"](#) on page 360
 - [":MTESt:RMODe:SIGMa"](#) on page 382
 - [":MTESt:RMODe:TIME"](#) on page 383
 - [":MTESt:RMODe:WAVeforms"](#) on page 384

Example Code • ["Example Code"](#) on page 360

:MTESt:RMODe:FACTion:MEASure

N (see [page 786](#))

Command Syntax :MTESt:RMODe:FACTion:MEASure <on_off>

<on_off> ::= {{1 | ON} | {0 | OFF}}

The :MTESt:RMODe:FACTion:MEASure command sets measuring only mask failures on or off.

When ON, measurements and measurement statistics run only on waveforms that contain a mask violation; passing waveforms do not affect measurements and measurement statistics.

This mode is not available when the acquisition mode is set to Averaging.

Query Syntax :MTESt:RMODe:FACTion:MEASure?

The :MTESt:RMODe:FACTion:MEASure? query returns the current mask failure measure setting.

Return Format <on_off><NL>

<on_off> ::= {1 | 0}

- See Also**
- "[Introduction to :MTESt Commands](#)" on page 360
 - "[:MTESt:RMODe:FACTion:PRINT](#)" on page 379
 - "[:MTESt:RMODe:FACTion:SAVE](#)" on page 380
 - "[:MTESt:RMODe:FACTion:STOP](#)" on page 381

:MTESt:RMODe:FACTion:PRINt

N (see [page 786](#))

Command Syntax :MTESt:RMODe:FACTion:PRINt <on_off>

<on_off> ::= {{1 | ON} | {0 | OFF}}

The :MTESt:RMODe:FACTion:PRINt command sets printing on mask failures on or off.

NOTE

Setting :MTESt:RMODe:FACTion:PRINt ON automatically sets :MTESt:RMODe:FACTion:SAVE OFF.

See "[:HARDcopy Commands](#)" on page 281 for more information on setting the hardcopy device and formatting options.

Query Syntax :MTESt:RMODe:FACTion:PRINt?

The :MTESt:RMODe:FACTion:PRINt? query returns the current mask failure print setting.

Return Format <on_off><NL>

<on_off> ::= {1 | 0}

- See Also**
- "[Introduction to :MTESt Commands](#)" on page 360
 - "[:MTESt:RMODe:FACTion:MEASure](#)" on page 378
 - "[:MTESt:RMODe:FACTion:SAVE](#)" on page 380
 - "[:MTESt:RMODe:FACTion:STOP](#)" on page 381

:MTESt:RMODe:FACTion:SAVE

N (see page 786)

Command Syntax :MTESt:RMODe:FACTion:SAVE <on_off>
<on_off> ::= {{1 | ON} | {0 | OFF}}

The :MTESt:RMODe:FACTion:SAVE command sets saving on mask failures on or off.

NOTE

Setting :MTESt:RMODe:FACTion:SAVE ON automatically sets :MTESt:RMODe:FACTion:PRINT OFF.

See "[:SAVE Commands](#)" on page 403 for more information on save options.

Query Syntax :MTESt:RMODe:FACTion:SAVE?

The :MTESt:RMODe:FACTion:SAVE? query returns the current mask failure save setting.

Return Format <on_off><NL>
<on_off> ::= {1 | 0}

- See Also**
- "[Introduction to :MTESt Commands](#)" on page 360
 - "[:MTESt:RMODe:FACTion:MEASure](#)" on page 378
 - "[:MTESt:RMODe:FACTion:PRINT](#)" on page 379
 - "[:MTESt:RMODe:FACTion:STOP](#)" on page 381

:MTESt:RMODe:FACTion:STOP

N (see [page 786](#))

Command Syntax :MTESt:RMODe:FACTion:STOP <on_off>

<on_off> ::= {{1 | ON} | {0 | OFF}}

The :MTESt:RMODe:FACTion:STOP command sets stopping on a mask failure on or off. When this setting is ON and a mask violation is detected, the mask test is stopped and the acquisition system is stopped.

Query Syntax :MTESt:RMODe:FACTion:STOP?

The :MTESt:RMODe:FACTion:STOP? query returns the current mask failure stop setting.

Return Format <on_off><NL>

<on_off> ::= {1 | 0}

- See Also**
- "[Introduction to :MTESt Commands](#)" on page 360
 - "[:MTESt:RMODe:FACTion:MEASure](#)" on page 378
 - "[:MTESt:RMODe:FACTion:PRINt](#)" on page 379
 - "[:MTESt:RMODe:FACTion:SAVE](#)" on page 380

:MTESt:RMODe:SIGMa

N (see [page 786](#))

Command Syntax :MTESt:RMODe:SIGMa <level>
<level> ::= from 0.1 to 9.3 in NR3 format

When the :MTESt:RMODe command is set to SIGMa, the :MTESt:RMODe:SIGMa command sets the *test sigma* level to which a mask test runs. *Test sigma* is the best achievable process sigma, assuming no failures. (*Process sigma* is calculated using the number of failures per test.) The *test sigma* level indirectly specifies the number of waveforms that must be tested (in order to reach the sigma level).

Query Syntax :MTESt:RMODe:SIGMa?

The :MTESt:RMODe:SIGMa? query returns the current Sigma level setting.

Return Format <level><NL>
<level> ::= from 0.1 to 9.3 in NR3 format

- See Also**
- ["Introduction to :MTESt Commands"](#) on page 360
 - [":MTESt:RMODe"](#) on page 377

- Example Code**
- ["Example Code"](#) on page 360

:MTESt:RMODe:TIME

N (see [page 786](#))

Command Syntax :MTESt:RMODe:TIME <seconds>

<seconds> ::= from 1 to 86400 in NR3 format

When the :MTESt:RMODe command is set to TIME, the :MTESt:RMODe:TIME command sets the number of seconds for a mask test to run.

Query Syntax :MTESt:RMODe:TIME?

The :MTESt:RMODe:TIME? query returns the number of seconds currently set.

Return Format <seconds><NL>

<seconds> ::= from 1 to 86400 in NR3 format

- See Also**
- "[Introduction to :MTESt Commands](#)" on page 360
 - "[:MTESt:RMODe](#)" on page 377

:MTESt:RMODe:WAVeforms

N (see [page 786](#))

Command Syntax :MTESt:RMODe:WAVeforms <count>

<count> ::= number of waveforms in NR1 format
from 1 to 2,000,000,000

When the :MTESt:RMODe command is set to WAVeforms, the :MTESt:RMODe:WAVeforms command sets the number of waveform acquisitions that are mask tested.

Query Syntax :MTESt:RMODe:WAVeforms?

The :MTESt:RMODe:WAVeforms? query returns the number of waveforms currently set.

Return Format <count><NL>

<count> ::= number of waveforms in NR1 format
from 1 to 2,000,000,000

- See Also**
- "[Introduction to :MTESt Commands](#)" on page 360
 - "[:MTESt:RMODe](#)" on page 377

:MTESt:SCALe:BIND

N (see [page 786](#))

Command Syntax :MTESt:SCALe:BIND <on_off>

<on_off> ::= {{1 | ON} | {0 | OFF}}

The :MTESt:SCALe:BIND command enables or disables Bind 1 & 0 Levels (Bind -1 & 0 Levels for inverted masks) control:

- ON –

If the Bind 1 & 0 Levels control is enabled, the 1 Level and the 0 Level controls track each other. Adjusting either the 1 Level or the 0 Level control shifts the position of the mask up or down without changing its size.

If the Bind -1 & 0 Levels control is enabled, the -1 Level and the 0 Level controls track each other. Adjusting either the -1 Level or the 0 Level control shifts the position of the mask up or down without changing its size.

- OFF –

If the Bind 1 & 0 Levels control is disabled, adjusting either the 1 Level or the 0 Level control changes the vertical height of the mask.

If the Bind -1 & 0 Levels control is disabled, adjusting either the -1 Level or the 0 Level control changes the vertical height of the mask.

Query Syntax :MTESt:SCALe:BIND?

The :MTESt:SCALe:BIND? query returns the value of the Bind 1&0 control (Bind -1&0 for inverted masks).

Return Format <on_off><NL>

<on_off> ::= {1 | 0}

- See Also**
- ["Introduction to :MTESt Commands"](#) on page 360
 - [":MTESt:SCALe:X1"](#) on page 386
 - [":MTESt:SCALe:XDELta"](#) on page 387
 - [":MTESt:SCALe:Y1"](#) on page 388
 - [":MTESt:SCALe:Y2"](#) on page 389

:MTEST:SCALE:X1

N (see [page 786](#))

Command Syntax :MTEST:SCALE:X1 <x1_value>
 <x1_value> ::= X1 value in NR3 format

The :MTEST:SCALE:X1 command defines where X=0 in the base coordinate system used for mask testing. The other X-coordinate is defined by the :MTEST:SCALE:XDELta command. Once the X1 and XDELta coordinates are set, all X values of vertices in the mask regions are defined with respect to this value, according to the equation:

$$X = (X * \Delta X) + X1$$

Thus, if you set X1 to 100 ms, and XDELta to 100 ms, an X value of 0.100 is a vertex at 110 ms.

The oscilloscope uses this equation to normalize vertices. This simplifies reprogramming to handle different data rates. For example, if you halve the period of the waveform of interest, you need only to adjust the XDELta value to set up the mask for the new waveform.

The X1 value is a time value specifying the location of the X1 coordinate, which will then be treated as X=0 for mask regions coordinates.

Query Syntax :MTEST:SCALE:X1?

The :MTEST:SCALE:X1? query returns the current X1 coordinate setting.

Return Format <x1_value><NL>
 <x1_value> ::= X1 value in NR3 format

- See Also**
- ["Introduction to :MTEST Commands"](#) on page 360
 - [":MTEST:SCALE:BIND"](#) on page 385
 - [":MTEST:SCALE:XDELta"](#) on page 387
 - [":MTEST:SCALE:Y1"](#) on page 388
 - [":MTEST:SCALE:Y2"](#) on page 389

:MTESt:SCALe:XDELta

N (see [page 786](#))

Command Syntax :MTESt:SCALe:XDELta <xdelta_value>
 <xdelta_value> ::= X delta value in NR3 format

The :MTESt:SCALe:XDELta command defines the position of the X2 marker with respect to the X1 marker. In the mask test coordinate system, the X1 marker defines where X=0; thus, the X2 marker defines where X=1.

Because all X vertices of the regions defined for mask testing are normalized with respect to X1 and ΔX , redefining ΔX also moves those vertices to stay in the same locations with respect to X1 and ΔX . Thus, in many applications, it is best if you define XDELta as a pulse width or bit period. Then, a change in data rate without corresponding changes in the waveform can easily be handled by changing ΔX .

The X-coordinate of polygon vertices is normalized using this equation:

$$X = (X * \Delta X) + X1$$

The X delta value is a time value specifying the distance of the X2 marker with respect to the X1 marker.

For example, if the period of the waveform you wish to test is 1 ms, setting ΔX to 1 ms ensures that the waveform's period is between the X1 and X2 markers.

Query Syntax :MTESt:SCALe:XDELta?

The :MTESt:SCALe:XDELta? query returns the current value of ΔX .

Return Format <xdelta_value><NL>
 <xdelta_value> ::= X delta value in NR3 format

- See Also**
- ["Introduction to :MTESt Commands"](#) on page 360
 - [":MTESt:SCALe:BIND"](#) on page 385
 - [":MTESt:SCALe:X1"](#) on page 386
 - [":MTESt:SCALe:Y1"](#) on page 388
 - [":MTESt:SCALe:Y2"](#) on page 389

:MTEST:SCALE:Y1

N (see [page 786](#))

Command Syntax :MTEST:SCALE:Y1 <y1_value>

<y1_value> ::= Y1 value in NR3 format

The :MTEST:SCALE:Y1 command defines where Y=0 in the coordinate system for mask testing. All Y values of vertices in the coordinate system are defined with respect to the boundaries set by SCALE:Y1 and SCALE:Y2 according to the equation:

$$Y = (Y * (Y2 - Y1)) + Y1$$

Thus, if you set Y1 to 100 mV, and Y2 to 1 V, a Y value of 0.100 in a vertex is at 190 mV.

The Y1 value is a voltage value specifying the point at which Y=0.

Query Syntax :MTEST:SCALE:Y1?

The :MTEST:SCALE:Y1? query returns the current setting of the Y1 marker.

Return Format <y1_value><NL>

<y1_value> ::= Y1 value in NR3 format

- See Also**
- ["Introduction to :MTEST Commands"](#) on page 360
 - [":MTEST:SCALE:BIND"](#) on page 385
 - [":MTEST:SCALE:X1"](#) on page 386
 - [":MTEST:SCALE:XDELta"](#) on page 387
 - [":MTEST:SCALE:Y2"](#) on page 389

:MTESt:SCALe:Y2

N (see [page 786](#))

Command Syntax :MTESt:SCALe:Y2 <y2_value>
 <y2_value> ::= Y2 value in NR3 format

The :MTESt:SCALe:Y2 command defines the Y2 marker in the coordinate system for mask testing. All Y values of vertices in the coordinate system are defined with respect to the boundaries defined by SCALe:Y1 and SCALe:Y2 according to the following equation:

$$Y = (Y * (Y2 - Y1)) + Y1$$

Thus, if you set Y1 to 100 mV, and Y2 to 1 V, a Y value of 0.100 in a vertex is at 190 mV.

The Y2 value is a voltage value specifying the location of the Y2 marker.

Query Syntax :MTESt:SCALe:Y2?

The :MTESt:SCALe:Y2? query returns the current setting of the Y2 marker.

Return Format <y2_value><NL>
 <y2_value> ::= Y2 value in NR3 format

- See Also**
- ["Introduction to :MTESt Commands"](#) on page 360
 - [":MTESt:SCALe:BIND"](#) on page 385
 - [":MTESt:SCALe:X1"](#) on page 386
 - [":MTESt:SCALe:XDELta"](#) on page 387
 - [":MTESt:SCALe:Y1"](#) on page 388

:MTESt:SOURce

N (see [page 786](#))

Command Syntax :MTESt:SOURce <source>

<source> ::= CHANnel<n>

<n> ::= {1 | 2 | 3 | 4} for the four channel oscilloscope models

<n> ::= {1 | 2} for the two channel oscilloscope models

The :MTESt:SOURce command selects the channel which is configured by the commands contained in a mask file when it is loaded.

Query Syntax :MTESt:SOURce?

The :MTESt:SOURce? query returns the channel which is configured by the commands contained in the current mask file.

Return Format <source><NL>

<source> ::= {CHAN<n> | NONE}

<n> ::= {1 | 2 | 3 | 4} for the four channel oscilloscope models

<n> ::= {1 | 2} for the two channel oscilloscope models

- See Also**
- ["Introduction to :MTESt Commands"](#) on page 360
 - [":MTESt:AMASk:SOURce"](#) on page 364

:MTESt:TITLe

N (see [page 786](#))

Query Syntax :MTESt:TITLe?

The :MTESt:TITLe? query returns the mask title which is a string of up to 128 characters. The title is displayed in the mask test dialog box and mask test tab when a mask file is loaded.

Return Format <title><NL>

<title> ::= a string of up to 128 ASCII characters.

See Also • ["Introduction to :MTESt Commands"](#) on page 360

:POD Commands

Control all oscilloscope functions associated with groups of digital channels. See "[Introduction to :POD<n> Commands](#)" on page 392.

Table 71 :POD<n> Commands Summary

Command	Query	Options and Query Returns
:POD<n>:DISPlay {{0 OFF} {1 ON}} (see page 393)	:POD<n>:DISPlay? (see page 393)	{0 1} <n> ::= 1-2 in NR1 format
:POD<n>:SIZE <value> (see page 394)	:POD<n>:SIZE? (see page 394)	<value> ::= {SMALl MEDium LARGe}
:POD<n>:THReshold <type>[suffix] (see page 395)	:POD<n>:THReshold? (see page 395)	<n> ::= 1-2 in NR1 format <type> ::= {CMOS ECL TTL <user defined value>} <user defined value> ::= value in NR3 format [suffix] ::= {V mV uV }

Introduction to :POD<n> Commands

<n> ::= {1 | 2}

The POD subsystem commands control the viewing and threshold of groups of digital channels.

POD1 ::= D0-D7

POD2 ::= D8-D15

NOTE

These commands are only valid for the MSO models.

Reporting the Setup

Use :POD1? or :POD2? to query setup information for the POD subsystem.

Return Format

The following is a sample response from the :POD1? query. In this case, the query was issued following a *RST command.

```
:POD1:DISP 0;THR +1.40E+00
```

:POD<n>:DISPlay

N (see [page 786](#))

Command Syntax :POD<n>:DISPlay <display>

<display> ::= {{1 | ON} | {0 | OFF}}

<n> ::= An integer, 1 or 2, is attached as a suffix to the command and defines the group of channels that are affected by the command.

POD1 ::= D0-D7

POD2 ::= D8-D15

The :POD<n>:DISPlay command turns displaying of the specified group of channels on or off.

NOTE

This command is only valid for the MSO models.

Query Syntax :POD<n>:DISPlay?

The :POD<n>:DISPlay? query returns the current display setting of the specified group of channels.

Return Format <display><NL>

<display> ::= {0 | 1}

- See Also**
- "[Introduction to :POD<n> Commands](#)" on page 392
 - "[:DIGital<n>:DISPlay](#)" on page 239
 - "[:CHANnel<n>:DISPlay](#)" on page 222
 - "[:VIEW](#)" on page 180
 - "[:BLANK](#)" on page 148
 - "[:STATus](#)" on page 177

:POD<n>:SIZE

N (see [page 786](#))

Command Syntax :POD<n>:SIZE <value>

<n> ::= An integer, 1 or 2, is attached as a suffix to the command and defines the group of channels that are affected by the command.

POD1 ::= D0-D7

POD2 ::= D8-D15

<value> ::= {SMALL | MEDIUM | LARGE}

The :POD<n>:SIZE command specifies the size of digital channels on the display.

NOTE

This command is only valid for the MSO models.

Query Syntax :POD<n>:SIZE?

The :POD<n>:SIZE? query returns the size setting for the specified group of channels.

Return Format <size_value><NL>

<size_value> ::= {SMALL | MEDIUM | LARGE}

- See Also**
- "[Introduction to :POD<n> Commands](#)" on page 392
 - "[:DIGital<n>:SIZE](#)" on page 242
 - "[:DIGital<n>:POSITION](#)" on page 241

:POD<n>:THReshold

N (see [page 786](#))

Command Syntax :POD<n>:THReshold <type>[<suffix>]

<n> ::= An integer, 1 or 2, is attached as a suffix to the command and defines the group of channels that are affected by the command.

<type> ::= {CMOS | ECL | TTL | <user defined value>}

<user defined value> ::= -8.00 to +8.00 in NR3 format

<suffix> ::= {V | mV | uV}

POD1 ::= D0-D7

POD2 ::= D8-D15

TTL ::= 1.4V

CMOS ::= 2.5V

ECL ::= -1.3V

The :POD<n>:THReshold command sets the threshold for the specified group of channels. The threshold is used for triggering purposes and for displaying the digital data as high (above the threshold) or low (below the threshold).

NOTE

This command is only valid for the MSO models.

Query Syntax :POD<n>:THReshold?

The :POD<n>:THReshold? query returns the threshold value for the specified group of channels.

Return Format <threshold><NL>

<threshold> ::= Floating point number in NR3 format

- See Also**
- "[Introduction to :POD<n> Commands](#)" on page 392
 - "[:DIGital<n>:THReshold](#)" on page 243
 - "[:TRIGger\[:EDGE\]:LEVel](#)" on page 501

Example Code

```
' THRESHOLD - This command is used to set the voltage threshold for
' the waveforms. There are three preset values (TTL, CMOS, and ECL)
' and you can also set a user-defined threshold value between
' -8.0 volts and +8.0 volts.
'
' In this example, we set channels 0-7 to CMOS, then set channels
' 8-15 to a user-defined 2.0 volts, and then set the external trigger
' to TTL. Of course, you only need to set the thresholds for the
' channels you will be using in your program.
```

5 Commands by Subsystem

```
' Set channels 0-7 to CMOS threshold.
myScope.WriteString ":POD1:THRESHOLD CMOS"

' Set channels 8-15 to 2.0 volts.
myScope.WriteString ":POD2:THRESHOLD 2.0"

' Set external channel to TTL threshold (short form).
myScope.WriteString ":TRIG:LEV TTL,EXT"
```

Example program from the start: ["VISA COM Example in Visual Basic"](#) on page 812

:RECall Commands

Recall previously saved oscilloscope setups and traces. See "Introduction to :RECall Commands" on page 397.

Table 72 :RECall Commands Summary

Command	Query	Options and Query Returns
:RECall:FILENAME <base_name> (see page 398)	:RECall:FILENAME? (see page 398)	<base_name> ::= quoted ASCII string
:RECall:IMAGE[:START] [<file_spec>] (see page 399)	n/a	<file_spec> ::= {<internal_loc> <file_name>} <internal_loc> ::= 0-9; an integer in NR1 format <file_name> ::= quoted ASCII string
:RECall:MASK[:START] [<file_spec>] (see page 400)	n/a	<file_spec> ::= {<internal_loc> <file_name>} <internal_loc> ::= 0-3; an integer in NR1 format <file_name> ::= quoted ASCII string
:RECall:PWD <path_name> (see page 401)	:RECall:PWD? (see page 401)	<path_name> ::= quoted ASCII string
:RECall:SETup[:START] [<file_spec>] (see page 402)	n/a	<file_spec> ::= {<internal_loc> <file_name>} <internal_loc> ::= 0-9; an integer in NR1 format <file_name> ::= quoted ASCII string

Introduction to :RECall Commands

The :RECall subsystem provides commands to recall previously saved oscilloscope setups and traces.

Reporting the Setup

Use :RECall? to query setup information for the RECall subsystem.

Return Format

The following is a sample response from the :RECall? query. In this case, the query was issued following the *RST command.

```
:REC:FIL "scope_0"
```

:RECall:FILEname

N (see [page 786](#))

Command Syntax :RECall:FILEname <base_name>

<base_name> ::= quoted ASCII string

The :RECall:FILEname command specifies the source for any RECall operations.

NOTE

This command specifies a file's base name only, without path information or an extension.

Query Syntax :RECall:FILEname?

The :RECall:FILEname? query returns the current RECall filename.

Return Format <base_name><NL>

<base_name> ::= quoted ASCII string

- See Also**
- ["Introduction to :RECall Commands"](#) on page 397
 - [":RECall:IMAGe\[:START\]"](#) on page 399
 - [":RECall:SETup\[:START\]"](#) on page 402
 - [":SAVE:FILEname"](#) on page 405

:RECall:IMAGe[:START]

N (see [page 786](#))

Command Syntax :RECall:IMAGe[:START] [<file_spec>]
 <file_spec> ::= {<internal_loc> | <file_name>}
 <internal_loc> ::= 0-9; an integer in NR1 format
 <file_name> ::= quoted ASCII string

The :RECall:IMAGe[:START] command recalls a trace (TIFF) image.

NOTE

If a file extension is provided as part of a specified <file_name>, it must be ".tif".

- See Also**
- "[Introduction to :RECall Commands](#)" on page 397
 - "[:RECall:FILEname](#)" on page 398
 - "[:SAVE:IMAGe\[:START\]](#)" on page 406

:RECall:MASK[:START]

N (see [page 786](#))

Command Syntax :RECall:MASK[:START] [<file_spec>]
<file_spec> ::= {<internal_loc> | <file_name>}
<internal_loc> ::= 0-3; an integer in NR1 format
<file_name> ::= quoted ASCII string

The :RECall:MASK[:START] command recalls a mask.

NOTE

If a file extension is provided as part of a specified <file_name>, it must be ".msk".

- See Also**
- ["Introduction to :RECall Commands"](#) on page 397
 - [":RECall:FILENAME"](#) on page 398
 - [":SAVE:MASK\[:START\]"](#) on page 413
 - [":MTEST:DATA"](#) on page 372

:RECall:PWD

N (see [page 786](#))

Command Syntax :RECall:PWD <path_name>
<path_name> ::= quoted ASCII string

The :RECall:PWD command sets the present working directory for recall operations.

Query Syntax :RECall:PWD?

The :RECall:PWD? query returns the currently set working directory for recall operations.

Return Format <path_name><NL>
<path_name> ::= quoted ASCII string

- See Also**
- ["Introduction to :RECall Commands"](#) on page 397
 - [":SAVE:PWD"](#) on page 414

:RECall:SETup[:START]

N (see [page 786](#))

Command Syntax :RECall:SETup[:START] [<file_spec>]
<file_spec> ::= {<internal_loc> | <file_name>}
<internal_loc> ::= 0-9; an integer in NR1 format
<file_name> ::= quoted ASCII string

The :RECall:SETup[:START] command recalls an oscilloscope setup.

NOTE

If a file extension is provided as part of a specified <file_name>, it must be ".scp".

-
- See Also**
- "[Introduction to :RECall Commands](#)" on page 397
 - "[:RECall:FILENAME](#)" on page 398
 - "[:SAVE:SETup\[:START\]](#)" on page 415

:SAVE Commands

Save oscilloscope setups and traces, screen images, and data. See "[Introduction to :SAVE Commands](#)" on page 404.

Table 73 :SAVE Commands Summary

Command	Query	Options and Query Returns
:SAVE:FILENAME <base_name> (see page 405)	:SAVE:FILENAME? (see page 405)	<base_name> ::= quoted ASCII string
:SAVE:IMAGE[:START] [<file_spec>] (see page 406)	n/a	<file_spec> ::= {<internal_loc> <file_name>} <internal_loc> ::= 0-9; an integer in NR1 format <file_name> ::= quoted ASCII string
n/a	:SAVE:IMAGE:AREA? (see page 407)	<area> ::= {GRAT SCR}
:SAVE:IMAGE:FACTors {{0 OFF} {1 ON}} (see page 408)	:SAVE:IMAGE:FACTors? (see page 408)	{0 1}
:SAVE:IMAGE:FORMat <format> (see page 409)	:SAVE:IMAGE:FORMat? (see page 409)	<format> ::= {TIFF {BMP BMP24bit} BMP8bit PNG NONE}
:SAVE:IMAGE:INKSaver {{0 OFF} {1 ON}} (see page 410)	:SAVE:IMAGE:INKSaver? (see page 410)	{0 1}
:SAVE:IMAGE:PALette <palette> (see page 411)	:SAVE:IMAGE:PALette? (see page 411)	<palette> ::= {COLor GRAYscale MONochrome}
:SAVE:LISTer[:START] [<file_name>] (see page 412)	n/a	<file_name> ::= quoted ASCII string
:SAVE:MASK[:START] [<file_spec>] (see page 413)	n/a	<file_spec> ::= {<internal_loc> <file_name>} <internal_loc> ::= 0-3; an integer in NR1 format <file_name> ::= quoted ASCII string
:SAVE:PWD <path_name> (see page 414)	:SAVE:PWD? (see page 414)	<path_name> ::= quoted ASCII string

Table 73 :SAVE Commands Summary (continued)

Command	Query	Options and Query Returns
:SAVE:SETup[:START] [<file_spec>] (see page 415)	n/a	<file_spec> ::= {<internal_loc> <file_name>} <internal_loc> ::= 0-9; an integer in NR1 format <file_name> ::= quoted ASCII string
:SAVE:WAVEform[:START] [<file_name>] (see page 416)	n/a	<file_name> ::= quoted ASCII string
:SAVE:WAVEform:FORMat <format> (see page 417)	:SAVE:WAVEform:FORMat ? (see page 417)	<format> ::= {ALB ASCiixy CSV BINary NONE}
:SAVE:WAVEform:LENGth <length> (see page 418)	:SAVE:WAVEform:LENGth ? (see page 418)	<length> ::= 100 to max. length; an integer in NR1 format
:SAVE:WAVEform:SEGMent <option> (see page 419)	:SAVE:WAVEform:SEGMent? (see page 419)	<option> ::= {ALL CURRent}

Introduction to :SAVE Commands

The :SAVE subsystem provides commands to save oscilloscope setups and traces, screen images, and data.

:SAV is an acceptable short form for :SAVE.

Reporting the Setup

Use :SAVE? to query setup information for the SAVE subsystem.

Return Format

The following is a sample response from the :SAVE? query. In this case, the query was issued following the *RST command.

```
:SAVE:FIL " "; :SAVE:IMAG:AREA GRAT;FACT 0;FORM TIFF;INKS 0;PAL
MON; :SAVE:PWD "C:/setups/"; :SAVE:WAV:FORM NONE;LENG 1000;SEGM CURR
```

:SAVE:FILEname

N (see [page 786](#))

Command Syntax :SAVE:FILEname <base_name>

<base_name> ::= quoted ASCII string

The :SAVE:FILEname command specifies the source for any SAVE operations.

NOTE

This command specifies a file's base name only, without path information or an extension.

Query Syntax :SAVE:FILEname?

The :SAVE:FILEname? query returns the current SAVE filename.

Return Format <base_name><NL>

<base_name> ::= quoted ASCII string

- See Also**
- ["Introduction to :SAVE Commands"](#) on page 404
 - [":SAVE:IMAGe\[:START\]"](#) on page 406
 - [":SAVE:SETup\[:START\]"](#) on page 415
 - [":SAVE:WAVEform\[:START\]"](#) on page 416
 - [":SAVE:PWD"](#) on page 414
 - [":RECall:FILEname"](#) on page 398

:SAVE:IMAGe[:START]

N (see [page 786](#))

Command Syntax :SAVE:IMAGe[:START] [<file_spec>]
<file_spec> ::= {<internal_loc> | <file_name>}
<internal_loc> ::= 0-9; an integer in NR1 format
<file_name> ::= quoted ASCII string

The :SAVE:IMAGe[:START] command saves an image.

NOTE

If a file extension is provided as part of a specified <file_name>, and it does not match the extension expected by the format specified in :SAVE:IMAGe:FORMat, the format will be changed if the extension is a valid image file extension.

NOTE

If the extension ".bmp" is used and the current :SAVE:IMAGe:FORMat is not BMP or BMP8, the format will be changed to BMP.

NOTE

When the <internal_loc> option is used, the :SAVE:IMAGe:FORMat will be changed to TIFF.

- See Also**
- ["Introduction to :SAVE Commands"](#) on page 404
 - [":SAVE:IMAGe:AREA"](#) on page 407
 - [":SAVE:IMAGe:FACTors"](#) on page 408
 - [":SAVE:IMAGe:FORMat"](#) on page 409
 - [":SAVE:IMAGe:INKSaver"](#) on page 410
 - [":SAVE:IMAGe:PALette"](#) on page 411
 - [":SAVE:FILEname"](#) on page 405
 - [":RECall:IMAGe\[:START\]"](#) on page 399

:SAVE:IMAGe:AREA

N (see [page 786](#))

Query Syntax :SAVE:IMAGe:AREA?

The :SAVE:IMAGe:AREA? query returns the selected image area. If the :SAVE:IMAGe:FORMat is TIFF, the area is GRAT (graticule). Otherwise, it is SCR (screen).

Return Format <area><NL>

<area> ::= {GRAT | SCR}

- See Also**
- "[Introduction to :SAVE Commands](#)" on page 404
 - "[:SAVE:IMAGe\[:START\]](#)" on page 406
 - "[:SAVE:IMAGe:FACTors](#)" on page 408
 - "[:SAVE:IMAGe:FORMat](#)" on page 409
 - "[:SAVE:IMAGe:INKSaver](#)" on page 410
 - "[:SAVE:IMAGe:PALette](#)" on page 411

:SAVE:IMAGe:FACTors

N (see [page 786](#))

Command Syntax :SAVE:IMAGe:FACTors <factors>
<factors> ::= {{OFF | 0} | {ON | 1}}

The :SAVE:IMAGe:FACTors command controls whether the oscilloscope factors are output along with the image.

NOTE

Factors are written to a separate file with the same path and base name but with the ".txt" extension.

Query Syntax :SAVE:IMAGe:FACTors?

The :SAVE:IMAGe:FACTors? query returns a flag indicating whether oscilloscope factors are output along with the image.

Return Format <factors><NL>
<factors> ::= {0 | 1}

- See Also**
- ["Introduction to :SAVE Commands"](#) on page 404
 - [":SAVE:IMAGe\[:START\]"](#) on page 406
 - [":SAVE:IMAGe:AREA"](#) on page 407
 - [":SAVE:IMAGe:FORMat"](#) on page 409
 - [":SAVE:IMAGe:INKSaver"](#) on page 410
 - [":SAVE:IMAGe:PALette"](#) on page 411

:SAVE:IMAGe:FORMat

N (see [page 786](#))

Command Syntax :SAVE:IMAGe:FORMat <format>

<format> ::= {TIFF | {BMP | BMP24bit} | BMP8bit | PNG}

The :SAVE:IMAGe:FORMat command sets the image format type.

Query Syntax :SAVE:IMAGe:FORMat?

The :SAVE:IMAGe:FORMat? query returns the selected image format type.

Return Format <format><NL>

<format> ::= {TIFF | BMP | BMP8 | PNG | NONE}

When NONE is returned, it indicates that a waveform data file format is currently selected.

- See Also**
- ["Introduction to :SAVE Commands"](#) on page 404
 - [":SAVE:IMAGe\[:START\]"](#) on page 406
 - [":SAVE:IMAGe:AREA"](#) on page 407
 - [":SAVE:IMAGe:FACTors"](#) on page 408
 - [":SAVE:IMAGe:INKSaver"](#) on page 410
 - [":SAVE:IMAGe:PALette"](#) on page 411
 - [":SAVE:WAVEform:FORMat"](#) on page 417

:SAVE:IMAGe:INKSaver

N (see [page 786](#))

Command Syntax :SAVE:IMAGe:INKSaver <value>

<value> ::= {{OFF | 0} | {ON | 1}}

The :SAVE:IMAGe:INKSaver command controls whether the graticule colors are inverted or not.

Query Syntax :SAVE:IMAGe:INKSaver?

The :SAVE:IMAGe:INKSaver? query returns a flag indicating whether graticule colors are inverted or not.

Return Format <value><NL>

<value> ::= {0 | 1}

- See Also**
- ["Introduction to :SAVE Commands"](#) on page 404
 - [":SAVE:IMAGe\[:START\]"](#) on page 406
 - [":SAVE:IMAGe:AREA"](#) on page 407
 - [":SAVE:IMAGe:FACTors"](#) on page 408
 - [":SAVE:IMAGe:FORMat"](#) on page 409
 - [":SAVE:IMAGe:PALette"](#) on page 411

:SAVE:IMAGe:PALette

N (see [page 786](#))

Command Syntax :SAVE:IMAGe:PALette <palette>
 <palette> ::= {COLor | GRAYscale | MONochrome}

The :SAVE:IMAGe:PALette command sets the image palette color.

NOTE

MONochrome is the only valid choice when the :SAVE:IMAGe:FORMat is TIFF. COLor and GRAYscale are the only valid choices when the format is not TIFF.

Query Syntax :SAVE:IMAGe:PALette?

The :SAVE:IMAGe:PALette? query returns the selected image palette color.

Return Format <palette><NL>
 <palette> ::= {COL | GRAY | MON}

- See Also**
- "[Introduction to :SAVE Commands](#)" on page 404
 - "[:SAVE:IMAGe\[:START\]](#)" on page 406
 - "[:SAVE:IMAGe:AREA](#)" on page 407
 - "[:SAVE:IMAGe:FACTors](#)" on page 408
 - "[:SAVE:IMAGe:FORMat](#)" on page 409
 - "[:SAVE:IMAGe:INKSaver](#)" on page 410

:SAVE:LISTer[:START]

N (see [page 786](#))

Command Syntax :SAVE:LISTer[:START] [<file_name>
<file_name> ::= quoted ASCII string

The :SAVE:LISTer[:START] command saves the Lister display data to a file.

NOTE

If a file extension is provided as part of a specified <file_name>, it must be ".csv".

-
- See Also**
- ["Introduction to :SAVE Commands"](#) on page 404
 - [":SAVE:FILENAME"](#) on page 405
 - [":LISTer Commands"](#) on page 292

:SAVE:MASK[:START]

N (see [page 786](#))

Command Syntax :SAVE:MASK[:START] [<file_spec>]
 <file_spec> ::= {<internal_loc> | <file_name>}
 <internal_loc> ::= 0-3; an integer in NR1 format
 <file_name> ::= quoted ASCII string

The :SAVE:MASK[:START] command saves a mask.

NOTE

If a file extension is provided as part of a specified <file_name>, it must be ".msk".

- See Also**
- ["Introduction to :SAVE Commands"](#) on page 404
 - [":SAVE:FILENAME"](#) on page 405
 - [":RECALL:MASK\[:START\]"](#) on page 400
 - [":MTEST:DATA"](#) on page 372

:SAVE:PWD

N (see [page 786](#))

Command Syntax :SAVE:PWD <path_name>
<path_name> ::= quoted ASCII string

The :SAVE:PWD command sets the present working directory for save operations.

Query Syntax :SAVE:PWD?

The :SAVE:PWD? query returns the currently set working directory for save operations.

Return Format <path_name><NL>
<path_name> ::= quoted ASCII string

- See Also**
- ["Introduction to :SAVE Commands"](#) on page 404
 - [":SAVE:FILENAME"](#) on page 405
 - [":RECALL:PWD"](#) on page 401

:SAVE:SETup[:START]

N (see [page 786](#))

Command Syntax :SAVE:SETup[:START] [<file_spec>]
 <file_spec> ::= {<internal_loc> | <file_name>}
 <internal_loc> ::= 0-9; an integer in NR1 format
 <file_name> ::= quoted ASCII string

The :SAVE:SETup[:START] command saves an oscilloscope setup.

NOTE

If a file extension is provided as part of a specified <file_name>, it must be ".scp".

- See Also**
- "[Introduction to :SAVE Commands](#)" on page 404
 - "[:SAVE:FILENAME](#)" on page 405
 - "[:RECall:SETup\[:START\]](#)" on page 402

:SAVE:WAVEform[:START]

N (see [page 786](#))

Command Syntax :SAVE:WAVEform[:START] [<file_name>]
<file_name> ::= quoted ASCII string

The :SAVE:WAVEform[:START] command saves oscilloscope waveform data to a file.

NOTE

If a file extension is provided as part of a specified <file_name>, and it does not match the extension expected by the format specified in :SAVE:WAVEform:FORMat, the format will be changed if the extension is a valid waveform file extension.

- See Also**
- ["Introduction to :SAVE Commands"](#) on page 404
 - [":SAVE:WAVEform:FORMat"](#) on page 417
 - [":SAVE:WAVEform:LENGth"](#) on page 418
 - [":SAVE:FILEname"](#) on page 405
 - [":RECall:SETup\[:START\]"](#) on page 402

:SAVE:WAVEform:FORMat

N (see [page 786](#))

Command Syntax :SAVE:WAVEform:FORMat <format>

<format> ::= {ALB | ASCiixy | CSV | BINary}

The :SAVE:WAVEform:FORMat command sets the waveform data format type:

- ALB – creates an Agilent module binary format file. These files can be viewed offline by the *Agilent Logic Analyzer* application software. The proper file extension for this format is ".alb".
- ASCiixy – creates comma-separated value files for each analog channel that is displayed (turned on). The proper file extension for this format is ".csv".
- CSV – creates one comma-separated value file that contains information for all analog channels that are displayed (turned on). The proper file extension for this format is ".csv".
- BINary – creates an oscilloscope binary data format file. See the *User's Guide* for a description of this format. The proper file extension for this format is ".bin".

Query Syntax :SAVE:WAVEform:FORMat?

The :SAVE:WAVEform:FORMat? query returns the selected waveform data format type.

Return Format <format><NL>

<format> ::= {ALB | ASC | CSV | BIN | NONE}

When NONE is returned, it indicates that an image file format is currently selected.

- See Also**
- "[Introduction to :SAVE Commands](#)" on page 404
 - "[:SAVE:WAVEform\[:START\]](#)" on page 416
 - "[:SAVE:WAVEform:LENGth](#)" on page 418
 - "[:SAVE:IMAGe:FORMat](#)" on page 409

:SAVE:WAVEform:LENGth

N (see [page 786](#))

Command Syntax :SAVE:WAVEform:LENGth <length>

<length> ::= 100 to max. length; an integer in NR1 format

The :SAVE:WAVEform:LENGth command sets the waveform data length (that is, the number of points saved).

Query Syntax :SAVE:WAVEform:LENGth?

The :SAVE:WAVEform:LENGth? query returns the specified waveform data length.

Return Format <length><NL>

<length> ::= 100 to max. length; an integer in NR1 format

- See Also**
- ["Introduction to :SAVE Commands"](#) on page 404
 - [":SAVE:WAVEform\[:START\]"](#) on page 416
 - [":WAVEform:POINTs"](#) on page 629
 - [":SAVE:WAVEform:FORMat"](#) on page 417

:SAVE:WAVEform:SEGmented

N (see [page 786](#))

Command Syntax :SAVE:WAVEform:SEGmented <option>

<option> ::= {ALL | CURRent}

When segmented memory is used for acquisitions, the :SAVE:WAVEform:SEGmented command specifies which segments are included when the waveform is saved:

- ALL – all acquired segments are saved.
- CURRent – only the currently selected segment is saved.

Query Syntax :SAVE:WAVEform:SEGmented?

The :SAVE:WAVEform:SEGmented? query returns the current segmented waveform save option setting.

Return Format <option><NL>

<option> ::= {ALL | CURR}

- See Also**
- ["Introduction to :SAVE Commands"](#) on page 404
 - [":SAVE:WAVEform\[:START\]"](#) on page 416
 - [":SAVE:WAVEform:FORMat"](#) on page 417
 - [":SAVE:WAVEform:LENGth"](#) on page 418

:SBUS Commands

Control oscilloscope functions associated with the serial decode bus. See "Introduction to :SBUS Commands" on page 421.

Table 74 :SBUS Commands Summary

Command	Query	Options and Query Returns
n/a	:SBUS:CAN:COUNT:ERROR? (see page 422)	<frame_count> ::= integer in NR1 format
n/a	:SBUS:CAN:COUNT:OVERLOAD? (see page 423)	<frame_count> ::= integer in NR1 format
:SBUS:CAN:COUNT:RESET (see page 424)	n/a	n/a
n/a	:SBUS:CAN:COUNT:TOTAL? (see page 425)	<frame_count> ::= integer in NR1 format
n/a	:SBUS:CAN:COUNT:UTILIZATION? (see page 426)	<percent> ::= floating-point in NR3 format
:SBUS:DISPLAY {{0 OFF} {1 ON}} (see page 427)	:SBUS:DISPLAY? (see page 427)	{0 1}
n/a	:SBUS:FLEXray:COUNT:NULL? (see page 428)	<frame_count> ::= integer in NR1 format
:SBUS:FLEXray:COUNT:RESET (see page 429)	n/a	n/a
n/a	:SBUS:FLEXray:COUNT:SYNC? (see page 430)	<frame_count> ::= integer in NR1 format
n/a	:SBUS:FLEXray:COUNT:TOTAL? (see page 431)	<frame_count> ::= integer in NR1 format
:SBUS:I2S:BASE <base> (see page 432)	:SBUS:I2S:BASE? (see page 432)	<base> ::= {DECIMAL HEX}
:SBUS:IIC:ASIZE <size> (see page 433)	:SBUS:IIC:ASIZE? (see page 433)	<size> ::= {BIT7 BIT8}
:SBUS:LIN:PARITY {{0 OFF} {1 ON}} (see page 434)	:SBUS:LIN:PARITY? (see page 434)	{0 1}
:SBUS:M1553:BASE <base> (see page 435)	:SBUS:M1553:BASE? (see page 435)	<base> ::= {DECIMAL HEX}
:SBUS:MODE <mode> (see page 436)	:SBUS:MODE? (see page 436)	<mode> ::= {CAN FLEXray I2S IIC LIN SPI UART}

Table 74 :SBUS Commands Summary (continued)

Command	Query	Options and Query Returns
:SBUS:SPI:BITorder <order> (see page 437)	:SBUS:SPI:BITorder? (see page 437)	<order> ::= {LSBFirst MSBFirst}
:SBUS:SPI:WIDTH <word_width> (see page 438)	:SBUS:SPI:WIDTH? (see page 438)	<word_width> ::= integer 4-16 in NR1 format
:SBUS:UART:BASE <base> (see page 439)	:SBUS:UART:BASE? (see page 439)	<base> ::= {ASCIi BINary HEX}
n/a	:SBUS:UART:COUNT:ERROR? (see page 440)	<frame_count> ::= integer in NR1 format
:SBUS:UART:COUNT:RESET (see page 441)	n/a	n/a
n/a	:SBUS:UART:COUNT:RXFRAMES? (see page 442)	<frame_count> ::= integer in NR1 format
n/a	:SBUS:UART:COUNT:TXFRAMES? (see page 443)	<frame_count> ::= integer in NR1 format
:SBUS:UART:FRAMing <value> (see page 444)	:SBUS:UART:FRAMing? (see page 444)	<value> ::= {OFF <decimal> <nondecimal>} <decimal> ::= 8-bit integer from 0-255 (0x00-0xff) <nondecimal> ::= #Hnn where n ::= {0,...,9 A,...,F} for hexadecimal <nondecimal> ::= #Bnn...n where n ::= {0 1} for binary

**Introduction to
:SBUS
Commands**

The :SBUS subsystem commands control the serial decode bus viewing, mode, and other options.

NOTE

These commands are only valid on 4 (analog) channel oscilloscope models when a serial decode option has been licensed.

Reporting the Setup

Use :SBUS? to query setup information for the :SBUS subsystem.

Return Format

The following is a sample response from the :SBUS? query. In this case, the query was issued following a *RST command.

```
:SBUS:DISP 0;MODE IIC
```

:SBUS:CAN:COUNT:ERRor

N (see [page 786](#))

Query Syntax :SBUS:CAN:COUNT:ERRor?

Returns the error frame count.

Return Format <frame_count><NL>

<frame_count> ::= integer in NR1 format

Errors • ["-241, Hardware missing"](#) on page 745

- See Also**
- [":SBUS:CAN:COUNT:RESet"](#) on page 424
 - ["Introduction to :SBUS Commands"](#) on page 421
 - [":SBUS:MODE"](#) on page 436
 - [":TRIGger:CAN Commands"](#) on page 478

:SBUS:CAN:COUNT:OVERload**N** (see [page 786](#))**Query Syntax** :SBUS:CAN:COUNT:OVERload?

Returns the overload frame count.

Return Format <frame_count><NL>

<frame_count> ::= integer in NR1 format

Errors • ["-241, Hardware missing"](#) on page 745

- See Also**
-
- [":SBUS:CAN:COUNT:RESet"](#)
- on page 424
-
-
- ["Introduction to :SBUS Commands"](#)
- on page 421
-
-
- [":SBUS:MODE"](#)
- on page 436
-
-
- [":TRIGger:CAN Commands"](#)
- on page 478

:SBUS:CAN:COUNT:RESet

N (see [page 786](#))

Command Syntax :SBUS:CAN:COUNT:RESet

Resets the frame counters.

Errors • "-241, Hardware missing" on [page 745](#)

- See Also**
- [":SBUS:CAN:COUNT:ERRor"](#) on [page 422](#)
 - [":SBUS:CAN:COUNT:OVERload"](#) on [page 423](#)
 - [":SBUS:CAN:COUNT:TOTal"](#) on [page 425](#)
 - [":SBUS:CAN:COUNT:UTILization"](#) on [page 426](#)
 - ["Introduction to :SBUS Commands"](#) on [page 421](#)
 - [":SBUS:MODE"](#) on [page 436](#)
 - [":TRIGger:CAN Commands"](#) on [page 478](#)

:SBUS:CAN:COUNT:TOTAL**N** (see [page 786](#))**Query Syntax** :SBUS:CAN:COUNT:TOTAL?

Returns the total frame count.

Return Format <frame_count><NL>

<frame_count> ::= integer in NR1 format

Errors • ["-241, Hardware missing"](#) on page 745

- See Also**
-
- [":SBUS:CAN:COUNT:RESet"](#)
- on page 424
-
-
- ["Introduction to :SBUS Commands"](#)
- on page 421
-
-
- [":SBUS:MODE"](#)
- on page 436
-
-
- [":TRIGger:CAN Commands"](#)
- on page 478

:SBUS:CAN:COUNT:UTILization

N (see [page 786](#))

Query Syntax :SBUS:CAN:COUNT:UTILization?

Returns the percent utilization.

Return Format <percent><NL>

<percent> ::= floating-point in NR3 format

Errors • ["-241, Hardware missing"](#) on page 745

- See Also**
- [":SBUS:CAN:COUNT:RESet"](#) on page 424
 - ["Introduction to :SBUS Commands"](#) on page 421
 - [":SBUS:MODE"](#) on page 436
 - [":TRIGger:CAN Commands"](#) on page 478

:SBUS:DISPlay

N (see [page 786](#))

Command Syntax :SBUS:DISPlay <display>
 <display> ::= {{1 | ON} | {0 | OFF}}

The :SBUS:DISPlay command turns displaying of the serial decode bus on or off.

NOTE

This command is only valid on 4 (analog) channel oscilloscope models when a serial decode option has been licensed.

Query Syntax :SBUS:DISPlay?

The :SBUS:DISPlay? query returns the current display setting of the serial decode bus.

Return Format <display><NL>
 <display> ::= {0 | 1}

Errors • ["-241, Hardware missing"](#) on page 745

See Also • ["Introduction to :SBUS Commands"](#) on page 421
 • [":CHANnel<n>:DISPlay"](#) on page 222
 • [":DIGital<n>:DISPlay"](#) on page 239
 • [":POD<n>:DISPlay"](#) on page 393
 • [":VIEW"](#) on page 180
 • [":BLANK"](#) on page 148
 • [":STATus"](#) on page 177

:SBUS:FLEXray:COUNT:NULL

N (see [page 786](#))

Query Syntax :SBUS:FLEXray:COUNT:NULL?

Returns the FlexRay null frame count.

Return Format <frame_count><NL>

<frame_count> ::= integer in NR1 format

Errors • "-241, Hardware missing" on [page 745](#)

- See Also**
- [":SBUS:FLEXray:COUNT:RESet"](#) on [page 429](#)
 - ["Introduction to :SBUS Commands"](#) on [page 421](#)
 - [":SBUS:MODE"](#) on [page 436](#)
 - [":TRIGger:FLEXray Commands"](#) on [page 505](#)

:SBUS:FLEXray:COUNT:RESet**N** (see [page 786](#))**Command Syntax** :SBUS:FLEXray:COUNT:RESet

Resets the FlexRay frame counters.

Errors • "-241, Hardware missing" on [page 745](#)

- See Also**
-
- [":SBUS:FLEXray:COUNT:NULL"](#)
- on
- [page 428](#)
-
-
- [":SBUS:FLEXray:COUNT:SYNC"](#)
- on
- [page 430](#)
-
-
- [":SBUS:FLEXray:COUNT:TOTAl"](#)
- on
- [page 431](#)
-
-
- ["Introduction to :SBUS Commands"](#)
- on
- [page 421](#)
-
-
- [":SBUS:MODE"](#)
- on
- [page 436](#)
-
-
- [":TRIGger:FLEXray Commands"](#)
- on
- [page 505](#)

:SBUS:FLEXray:COUNT:SYNC

N (see [page 786](#))

Query Syntax :SBUS:FLEXray:COUNT:SYNC?

Returns the FlexRay sync frame count.

Return Format <frame_count><NL>

<frame_count> ::= integer in NR1 format

Errors • "-241, Hardware missing" on [page 745](#)

- See Also**
- [":SBUS:FLEXray:COUNT:RESet"](#) on [page 429](#)
 - ["Introduction to :SBUS Commands"](#) on [page 421](#)
 - [":SBUS:MODE"](#) on [page 436](#)
 - [":TRIGger:FLEXray Commands"](#) on [page 505](#)

:SBUS:FLEXray:COUNT:TOTal**N** (see [page 786](#))**Query Syntax** :SBUS:FLEXray:COUNT:TOTal?

Returns the FlexRay total frame count.

Return Format <frame_count><NL>

<frame_count> ::= integer in NR1 format

Errors • ["-241, Hardware missing"](#) on page 745

- See Also**
-
- [":SBUS:FLEXray:COUNT:RESet"](#)
- on page 429
-
-
- ["Introduction to :SBUS Commands"](#)
- on page 421
-
-
- [":SBUS:MODE"](#)
- on page 436
-
-
- [":TRIGger:FLEXray Commands"](#)
- on page 505

:SBUS:I2S:BASE

N (see [page 786](#))

Command Syntax :SBUS:I2S:BASE <base>
<base> ::= {DECimal | HEX}

The :SBUS:I2S:BASE command determines the base to use for the I2S decode display.

NOTE

This command is only valid on 4 (analog) channel oscilloscope models when the I2S serial decode option (Option SND) has been licensed.

Query Syntax :SBUS:I2S:BASE?

The :SBUS:I2S:BASE? query returns the current I2S display decode base.

Return Format <base><NL>
<base> ::= {DECimal | HEX}

Errors • ["-241, Hardware missing"](#) on page 745

See Also • ["Introduction to :SBUS Commands"](#) on page 421
• [":TRIGger:I2S Commands"](#) on page 526

:SBUS:IIC:ASIZE

N (see [page 786](#))

Command Syntax :SBUS:IIC:ASIZE <size>
 <size> ::= {BIT7 | BIT8}

The :SBUS:IIC:ASIZE command determines whether the Read/Write bit is included as the LSB in the display of the IIC address field of the decode bus.

NOTE

This command is only valid on 4 (analog) channel oscilloscope models when the low-speed IIC and SPI serial decode option (Option LSS) has been licensed.

Query Syntax :SBUS:IIC:ASIZE?

The :SBUS:IIC:ASIZE? query returns the current IIC address width setting.

Return Format <mode><NL>
 <mode> ::= {BIT7 | BIT8}

Errors • "-241, Hardware missing" on [page 745](#)

See Also • "Introduction to :SBUS Commands" on [page 421](#)
 • ":TRIGger:IIC Commands" on [page 544](#)

:SBUS:LIN:PARity

N (see [page 786](#))

Command Syntax :SBUS:LIN:PARity <display>
<display> ::= {{1 | ON} | {0 | OFF}}

The :SBUS:LIN:PARity command determines whether the parity bits are included as the most significant bits (MSB) in the display of the Frame Id field in the LIN decode bus.

NOTE

This command is only valid on 4 (analog) channel oscilloscope models when the automotive CAN and LIN serial decode option (Option AMS) has been licensed.

Query Syntax :SBUS:LIN:PARity?

The :SBUS:LIN:PARity? query returns the current LIN parity bits display setting of the serial decode bus.

Return Format <display><NL>
<display> ::= {0 | 1}

Errors • "-241, Hardware missing" on [page 745](#)

See Also • "Introduction to :SBUS Commands" on [page 421](#)
• ":TRIGger:LIN Commands" on [page 553](#)

:SBUS:M1553:BASE

N (see [page 786](#))

Command Syntax :SBUS:M1553:BASE <base>
 <base> ::= {BINary | HEX}

The :SBUS:M1553:BASE command determines the base to use for the MIL-STD 1553 decode display.

NOTE

This command is only valid on 4 (analog) channel oscilloscope models when the MIL-STD 1553 serial decode option (Option 553) has been licensed.

Query Syntax :SBUS:M1553:BASE?

The :SBUS:M1553:BASE? query returns the current MIL-STD 1553 display decode base.

Return Format <base><NL>
 <base> ::= {BIN | HEX}

Errors • "-241, Hardware missing" on [page 745](#)

See Also • "[Introduction to :SBUS Commands](#)" on [page 421](#)
 • "[:TRIGger:M1553 Commands](#)" on [page 566](#)

:SBUS:MODE

N (see [page 786](#))

Command Syntax :SBUS:MODE <mode>

<mode> ::= {CAN | FLEXray | I2S | IIC | LIN | M1553 | SPI | UART}

The :SBUS:MODE command determines the decode mode for the serial bus.

NOTE

This command is only valid on 4 (analog) channel oscilloscope models when a serial decode option has been licensed.

Query Syntax :SBUS:MODE?

The :SBUS:MODE? query returns the current serial bus decode mode setting.

Return Format <mode><NL>

<mode> ::= {CAN | FLEX | I2S | IIC | LIN | M1553 | SPI | UART | NONE}

Errors • "-241, Hardware missing" on [page 745](#)

- See Also**
- "[Introduction to :SBUS Commands](#)" on [page 421](#)
 - "[:TRIGger:MODE](#)" on [page 473](#)
 - "[:TRIGger:CAN Commands](#)" on [page 478](#)
 - "[:TRIGger:FLEXray Commands](#)" on [page 505](#)
 - "[:TRIGger:I2S Commands](#)" on [page 526](#)
 - "[:TRIGger:IIC Commands](#)" on [page 544](#)
 - "[:TRIGger:LIN Commands](#)" on [page 553](#)
 - "[:TRIGger:M1553 Commands](#)" on [page 566](#)
 - "[:TRIGger:SPI Commands](#)" on [page 581](#)
 - "[:TRIGger:UART Commands](#)" on [page 596](#)

:SBUS:SPI:BITorder

N (see [page 786](#))

Command Syntax :SBUS:SPI:BITorder <order>
 <order> ::= {LSBFirst | MSBFirst}

The :SBUS:SPI:BITorder command selects the bit order, most significant bit first (MSB) or least significant bit first (LSB), used when displaying data in the serial decode waveform and in the Lister.

NOTE

This command is only valid on 4 (analog) channel oscilloscope models when the low-speed IIC and SPI serial decode option (Option LSS) has been licensed.

Query Syntax :SBUS:SPI:BITorder?

The :SBUS:SPI:BITorder? query returns the current SPI decode bit order.

Return Format <order><NL>
 <order> ::= {LSBF | MSBF}

Errors • "-241, Hardware missing" on [page 745](#)

See Also • ["Introduction to :SBUS Commands"](#) on [page 421](#)
 • [":SBUS:MODE"](#) on [page 436](#)
 • [":TRIGger:SPI Commands"](#) on [page 581](#)

:SBUS:SPI:WIDTH

N (see [page 786](#))

Command Syntax :SBUS:SPI:WIDTH <word_width>
<word_width> ::= integer 4-16 in NR1 format

The :SBUS:SPI:WIDTH command determines the number of bits in a word of data for SPI.

NOTE

This command is only valid on 4 (analog) channel oscilloscope models when the low-speed IIC and SPI serial decode option (Option LSS) has been licensed.

Query Syntax :SBUS:SPI:WIDTH?

The :SBUS:SPI:WIDTH? query returns the current SPI decode word width.

Return Format <word_width><NL>
<word_width> ::= integer 4-16 in NR1 format

Errors • ["-241, Hardware missing"](#) on [page 745](#)

See Also • ["Introduction to :SBUS Commands"](#) on [page 421](#)
• [":SBUS:MODE"](#) on [page 436](#)
• [":TRIGger:SPI Commands"](#) on [page 581](#)

:SBUS:UART:BASE

N (see [page 786](#))

Command Syntax :SBUS:UART:BASE <base>
 <base> ::= {ASCii | BINary | HEX}

The :SBUS:UART:BASE command determines the base to use for the UART decode display.

NOTE

This command is only valid on 4 (analog) channel oscilloscope models when the UART/RS-232 triggering and serial decode option (Option 232) has been licensed.

Query Syntax :SBUS:UART:BASE?

The :SBUS:UART:BASE? query returns the current UART decode base setting.

Return Format <base><NL>
 <base> ::= {ASCii | BINary | HEX}

Errors • "-241, Hardware missing" on [page 745](#)

See Also • "[Introduction to :SBUS Commands](#)" on [page 421](#)
 • "[:TRIGger:UART Commands](#)" on [page 596](#)

:SBUS:UART:COUNT:ERRor

N (see [page 786](#))

Query Syntax :SBUS:UART:COUNT:ERRor?

Returns the UART error frame count.

NOTE

This command is only valid on 4 (analog) channel oscilloscope models when the UART/RS-232 triggering and serial decode option (Option 232) has been licensed.

Return Format <frame_count><NL>

<frame_count> ::= integer in NR1 format

Errors • "-241, Hardware missing" on [page 745](#)

- See Also**
- [":SBUS:UART:COUNT:RESet"](#) on [page 441](#)
 - ["Introduction to :SBUS Commands"](#) on [page 421](#)
 - [":SBUS:MODE"](#) on [page 436](#)
 - [":TRIGger:UART Commands"](#) on [page 596](#)

:SBUS:UART:COUNt:RESet**N** (see [page 786](#))**Command Syntax** :SBUS:UART:COUNt:RESet

Resets the UART frame counters.

NOTE

This command is only valid on 4 (analog) channel oscilloscope models when the UART/RS-232 triggering and serial decode option (Option 232) has been licensed.

-
- Errors**
- ["-241, Hardware missing"](#) on page 745
- See Also**
- [":SBUS:UART:COUNt:ERRor"](#) on page 440
 - [":SBUS:UART:COUNt:RXFRames"](#) on page 442
 - [":SBUS:UART:COUNt:TXFRames"](#) on page 443
 - ["Introduction to :SBUS Commands"](#) on page 421
 - [":SBUS:MODE"](#) on page 436
 - [":TRIGger:UART Commands"](#) on page 596

:SBUS:UART:COUNt:RXFRames

N (see [page 786](#))

Query Syntax :SBUS:UART:COUNt:RXFRames?

Returns the UART Rx frame count.

NOTE

This command is only valid on 4 (analog) channel oscilloscope models when the UART/RS-232 triggering and serial decode option (Option 232) has been licensed.

Return Format <frame_count><NL>

<frame_count> ::= integer in NR1 format

Errors • "-241, Hardware missing" on [page 745](#)

- See Also**
- [":SBUS:UART:COUNt:RESet"](#) on [page 441](#)
 - ["Introduction to :SBUS Commands"](#) on [page 421](#)
 - [":SBUS:MODE"](#) on [page 436](#)
 - [":TRIGger:UART Commands"](#) on [page 596](#)

:SBUS:UART:COUNt:TXFRames**N** (see [page 786](#))**Query Syntax** :SBUS:UART:COUNt:TXFRames?

Returns the UART Tx frame count.

NOTE

This command is only valid on 4 (analog) channel oscilloscope models when the UART/RS-232 triggering and serial decode option (Option 232) has been licensed.

Return Format <frame_count><NL>

<frame_count> ::= integer in NR1 format

Errors • "-241, Hardware missing" on [page 745](#)

- See Also**
-
- [":SBUS:UART:COUNt:RESet"](#)
- on
- [page 441](#)
-
-
- ["Introduction to :SBUS Commands"](#)
- on
- [page 421](#)
-
-
- [":SBUS:MODE"](#)
- on
- [page 436](#)
-
-
- [":TRIGger:UART Commands"](#)
- on
- [page 596](#)

:SBUS:UART:FRAMing

N (see [page 786](#))

Command Syntax :SBUS:UART:FRAMing <value>
 <value> ::= {OFF | <decimal> | <nondecimal>}
 <decimal> ::= 8-bit integer in decimal from 0-255 (0x00-0xff)
 <nondecimal> ::= #Hnn where n ::= {0,...,9 | A,...,F} for hexadecimal
 <nondecimal> ::= #Bnn...n where n ::= {0 | 1} for binary

The :SBUS:UART:FRAMing command determines the byte value to use for framing (end of packet) or to turn off framing for UART decode.

NOTE

This command is only valid on 4 (analog) channel oscilloscope models when the UART/RS-232 triggering and serial decode option (Option 232) has been licensed.

Query Syntax :SBUS:UART:FRAMing?

The :SBUS:UART:FRAMing? query returns the current UART decode base setting.

Return Format <value><NL>
 <value> ::= {OFF | <decimal>}
 <decimal> ::= 8-bit integer in decimal from 0-255

Errors • "-241, Hardware missing" on [page 745](#)

See Also • ["Introduction to :SBUS Commands"](#) on [page 421](#)
 • [":TRIGger:UART Commands"](#) on [page 596](#)

:SYSTEM Commands

Control basic system functions of the oscilloscope. See "Introduction to :SYSTEM Commands" on page 445.

Table 75 :SYSTEM Commands Summary

Command	Query	Options and Query Returns
:SYSTEM:DATE <date> (see page 446)	:SYSTEM:DATE? (see page 446)	<date> ::= <year>,<month>,<day> <year> ::= 4-digit year in NR1 format <month> ::= {1,...,12 JANuary FEBruary MARch APRil MAY JUNE JULy AUGust SEPTember OCTober NOVember DECember} <day> ::= {1,..31}
:SYSTEM:DSP <string> (see page 447)	n/a	<string> ::= up to 254 characters as a quoted ASCII string
n/a	:SYSTEM:ERROR? (see page 448)	<error> ::= an integer error code <error string> ::= quoted ASCII string. See Error Messages (see page 743).
:SYSTEM:LOCK <value> (see page 449)	:SYSTEM:LOCK? (see page 449)	<value> ::= {{1 ON} {0 OFF}}
:SYSTEM:PRECision <value> (see page 450)	:SYSTEM:PRECision? (see page 450)	<value> ::= {{1 ON} {0 OFF}}
:SYSTEM:PROTection:LOCK <value> (see page 451)	:SYSTEM:PROTection:LOCK? (see page 451)	<value> ::= {{1 ON} {0 OFF}}
:SYSTEM:SETup <setup_data> (see page 452)	:SYSTEM:SETup? (see page 452)	<setup_data> ::= data in IEEE 488.2 # format.
:SYSTEM:TIME <time> (see page 454)	:SYSTEM:TIME? (see page 454)	<time> ::= hours,minutes,seconds in NR1 format

Introduction to :SYSTEM Commands SYSTEM subsystem commands enable writing messages to the display, setting and reading both the time and the date, querying for errors, and saving and recalling setups.

:SYSTem:DATE

N (see [page 786](#))

Command Syntax :SYSTem:DATE <date>

<date> ::= <year>,<month>,<day>

<year> ::= 4-digit year in NR1 format

<month> ::= {1,...,12 | JANuary | FEBruary | MARCH | APRil | MAY | JUNE
| JULy | AUGust | SEPTember | OCTober | NOVember | DECember}

<day> ::= {1,...,31}

The :SYSTem:DATE command sets the date. Validity checking is performed to ensure that the date is valid.

Query Syntax :SYSTem:DATE?

The SYSTem:DATE? query returns the date.

Return Format <year>,<month>,<day><NL>

- See Also**
- "[Introduction to :SYSTem Commands](#)" on page 445
 - "[:SYSTem:TIME](#)" on page 454

:SYSTem:DSP

N (see [page 786](#))

Command Syntax :SYSTem:DSP <string>
<string> ::= quoted ASCII string (up to 254 characters)

The :SYSTem:DSP command writes the quoted string (excluding quotation marks) to a text box in the center of the display. Use :SYSTem:DSP "" to remotely remove the message from the display. (Two sets of quote marks without a space between them creates a NULL string.) Press any menu key to manually remove the message from the display.

See Also • ["Introduction to :SYSTem Commands"](#) on page 445

:SYSTem:ERRor

C (see [page 786](#))

Query Syntax :SYSTem:ERRor?

The :SYSTem:ERRor? query outputs the next error number and text from the error queue. The instrument has an error queue that is 30 errors deep and operates on a first-in, first-out basis. Repeatedly sending the :SYSTem:ERRor? query returns the errors in the order that they occurred until the queue is empty. Any further queries then return zero until another error occurs.

Return Format <error number>,<error string><NL>

<error number> ::= an integer error code in NR1 format

<error string> ::= quoted ASCII string containing the error message

Error messages are listed in [Chapter 8](#), “Error Messages,” starting on page 743.

- See Also**
- ["Introduction to :SYSTem Commands"](#) on page 445
 - ["*ESR \(Standard Event Status Register\)"](#) on page 120
 - ["*CLS \(Clear Status\)"](#) on page 117

:SYSTem:LOCK

N (see [page 786](#))

Command Syntax :SYSTem:LOCK <value>
<value> ::= {{1 | ON} | {0 | OFF}}

The :SYSTem:LOCK command disables the front panel. LOCK ON is the equivalent of sending a local lockout message over the programming interface.

Query Syntax :SYSTem:LOCK?

The :SYSTem:LOCK? query returns the lock status of the front panel.

Return Format <value><NL>
<value> ::= {1 | 0}

See Also • ["Introduction to :SYSTem Commands"](#) on page 445

:SYSTem:PRECision

N (see [page 786](#))

Command Syntax :SYSTem:PRECision <value>
 <value> ::= {{1 | ON} | {0 | OFF}}

The :SYSTem:PRECision command turns the oscilloscope's precision analysis setting on or off.

- OFF (0) – provides the maximum oscilloscope waveform update rate by performing measurements and math functions on a 1000-point *measurement record*.
- ON (1) – at the expense of oscilloscope waveform update rate, this setting allows measurements and math functions to be performed on a *precision analysis record* (see [":WAVEform:POINts:MODE"](#) on page 631).

The precision analysis setting is OFF after a *RST command.

Precision analysis is not available when:

- Realtime sampling mode is off.
- Averaging or High Resolution acquisition modes are selected.
- XY or Roll time modes are selected.

Query Syntax :SYSTem:PRECision?

The :SYSTem:PRECision? query returns the current precision analysis setting.

Return Format <value><NL>
 <value> ::= {1 | 0}

- See Also**
- ["Introduction to :SYSTem Commands"](#) on page 445
 - [":WAVEform:POINts:MODE"](#) on page 631
 - ["*RST \(Reset\)"](#) on page 128

:SYSTem:PROTection:LOCK**N** (see [page 786](#))

Command Syntax :SYSTem:PROTection:LOCK <value>
<value> ::= {{1 | ON} | {0 | OFF}}

The :SYSTem:PROTection:LOCK command disables the fifty ohm impedance setting for all analog channels.

Query Syntax :SYSTem:PROTection:LOCK?

The :SYSTem:PROTection:LOCK? query returns the analog channel protection lock status.

Return Format <value><NL>
<value> ::= {1 | 0}

See Also • ["Introduction to :SYSTem Commands"](#) on page 445

:SYSTem:SETup

C (see [page 786](#))

Command Syntax :SYSTem:SETup <setup_data>

<setup_data> ::= binary block data in IEEE 488.2 # format.

The :SYSTem:SETup command sets the oscilloscope as defined by the data in the setup (learn) string sent from the controller. The setup string does not change the interface mode or interface address.

Query Syntax :SYSTem:SETup?

The :SYSTem:SETup? query operates the same as the *LRN? query. It outputs the current oscilloscope setup in the form of a learn string to the controller. The setup (learn) string is sent and received as a binary block of data. The format for the data transmission is the # format defined in the IEEE 488.2 specification.

Return Format <setup_data><NL>

<setup_data> ::= binary block data in IEEE 488.2 # format

- See Also**
- ["Introduction to :SYSTem Commands"](#) on page 445
 - ["*LRN \(Learn Device Setup\)"](#) on page 123

Example Code

```
' SAVE_SYSTEM_SETUP - The :SYSTEM:SETUP? query returns a program
' message that contains the current state of the instrument. Its
' format is a definite-length binary block, for example,
' #800002204<setup string><NL>
' where the setup string is 2204 bytes in length.
myScope.WriteString ":SYSTEM:SETUP?"
varQueryResult = myScope.ReadIEEEBlock(BinaryType_UI1)
CheckForInstrumentErrors ' After reading query results.

' Output setup string to a file:
Dim strPath As String
strPath = "c:\scope\config\setup.dat"

' Open file for output.
Close #1 ' If #1 is open, close it.
Open strPath For Binary Access Write Lock Write As #1
Put #1, , varQueryResult ' Write data.
Close #1 ' Close file.

' RESTORE_SYSTEM_SETUP - Read the setup string from a file and
' write it back to the oscilloscope.
Dim varSetupString As Variant
strPath = "c:\scope\config\setup.dat"

' Open file for input.
Open strPath For Binary Access Read As #1
Get #1, , varSetupString ' Read data.
Close #1 ' Close file.
```

```
' Write setup string back to oscilloscope using ":SYSTEM:SETUP"  
' command:  
myScope.WriteIEEEBlock ":SYSTEM:SETUP ", varSetupString  
CheckForInstrumentErrors
```

Example program from the start: ["VISA COM Example in Visual Basic"](#) on page 812

:SYSTem:TIME

N (see [page 786](#))

Command Syntax :SYSTem:TIME <time>

<time> ::= hours,minutes,seconds in NR1 format

The :SYSTem:TIME command sets the system time, using a 24-hour format. Commas are used as separators. Validity checking is performed to ensure that the time is valid.

Query Syntax :SYSTem:TIME? <time>

The :SYSTem:TIME? query returns the current system time.

Return Format <time><NL>

<time> ::= hours,minutes,seconds in NR1 format

- See Also**
- ["Introduction to :SYSTem Commands"](#) on page 445
 - [":SYSTem:DATE"](#) on page 446

:TIMebase Commands

Control all horizontal sweep functions. See "Introduction to :TIMebase Commands" on page 456.

Table 76 :TIMebase Commands Summary

Command	Query	Options and Query Returns
:TIMebase:MODE <value> (see page 457)	:TIMebase:MODE? (see page 457)	<value> ::= {MAIN WINDow XY ROLL}
:TIMebase:POSition <pos> (see page 458)	:TIMebase:POSition? (see page 458)	<pos> ::= time from the trigger event to the display reference point in NR3 format
:TIMebase:RANGe <range_value> (see page 459)	:TIMebase:RANGe? (see page 459)	<range_value> ::= 5 ns through 500 s in NR3 format
:TIMebase:REFClock {0 OFF} {1 ON} (see page 460)	:TIMebase:REFClock? (see page 460)	{0 1}
:TIMebase:REFerence {LEFT CENTer RIGHT} (see page 461)	:TIMebase:REFerence? (see page 461)	<return_value> ::= {LEFT CENTer RIGHT}
:TIMebase:SCALe <scale_value> (see page 462)	:TIMebase:SCALe? (see page 462)	<scale_value> ::= scale value in seconds in NR3 format
:TIMebase:VERNier {0 OFF} {1 ON} (see page 463)	:TIMebase:VERNier? (see page 463)	{0 1}
:TIMebase:WINDow:POSition <pos> (see page 464)	:TIMebase:WINDow:POSition? (see page 464)	<pos> ::= time from the trigger event to the zoomed view reference point in NR3 format
:TIMebase:WINDow:RANGe <range_value> (see page 465)	:TIMebase:WINDow:RANGe? (see page 465)	<range value> ::= range value in seconds in NR3 format for the zoomed window
:TIMebase:WINDow:SCALe <scale_value> (see page 466)	:TIMebase:WINDow:SCALe? (see page 466)	<scale_value> ::= scale value in seconds in NR3 format for the zoomed window

5 Commands by Subsystem

Introduction to :TIMEbase Commands The TIMEbase subsystem commands control the horizontal (X-axis) functions and set the oscilloscope to X-Y mode (where channel 1 becomes the X input and channel 2 becomes the Y input). The time per division, delay, vernier control, and reference can be controlled for the main and window (zoomed) time bases.

Reporting the Setup

Use :TIMEbase? to query setup information for the TIMEbase subsystem.

Return Format

The following is a sample response from the :TIMEbase? query. In this case, the query was issued following a *RST command.

```
:TIM:MODE MAIN;REF CENT;MAIN:RANG +1.00E-03;POS +0.0E+00
```

:TIMEbase:MODE

C (see [page 786](#))

Command Syntax :TIMEbase:MODE <value>
 <value> ::= {MAIN | WINDow | XY | ROLL}

The :TIMEbase:MODE command sets the current time base. There are four time base modes:

- **MAIN** – The normal time base mode is the main time base. It is the default time base mode after the *RST (Reset) command.
- **WINDow** – In the WINDow (zoomed or delayed) time base mode, measurements are made in the zoomed time base if possible; otherwise, the measurements are made in the main time base.
- **XY** – In the XY mode, the :TIMEbase:RANGe, :TIMEbase:POSition, and :TIMEbase:REFerence commands are not available. No measurements are available in this mode.
- **ROLL** – In the ROLL mode, data moves continuously across the display from left to right. The oscilloscope runs continuously and is untriggered. The :TIMEbase:REFerence selection changes to RIGHT.

NOTE

If a :DIGitize command is executed when the :TIMEbase:MODE is not MAIN, the :TIMEbase:MODE is set to MAIN.

Query Syntax :TIMEbase:MODE?

The :TIMEbase:MODE query returns the current time base mode.

Return Format <value><NL>
 <value> ::= {MAIN | WIND | XY | ROLL}

- See Also**
- ["Introduction to :TIMEbase Commands"](#) on page 456
 - ["*RST \(Reset\)"](#) on page 128
 - [":TIMEbase:RANGe"](#) on page 459
 - [":TIMEbase:POSition"](#) on page 458
 - [":TIMEbase:REFerence"](#) on page 461

Example Code

```
' TIMEBASE_MODE - (not executed in this example)
' Set the time base mode to MAIN, DELAYED, XY, or ROLL.

' Set time base mode to main.
myScope.WriteString ":TIMEBASE:MODE MAIN"
```

Example program from the start: ["VISA COM Example in Visual Basic"](#) on page 812

:TIMEbase:POSition

C (see [page 786](#))

Command Syntax :TIMEbase:POSition <pos>

<pos> ::= time in seconds from the trigger to the display reference
in NR3 format

The :TIMEbase:POSition command sets the time interval between the trigger event and the display reference point on the screen. The display reference point is either left, right, or center and is set with the :TIMEbase:REFerence command. The maximum position value depends on the time/division settings.

NOTE

This command is an alias for the :TIMEbase:DELay command.

Query Syntax :TIMEbase:POSition?

The :TIMEbase:POSition? query returns the current time from the trigger to the display reference in seconds.

Return Format <pos><NL>

<pos> ::= time in seconds from the trigger to the display reference
in NR3 format

- See Also**
- "[Introduction to :TIMEbase Commands](#)" on page 456
 - "[:TIMEbase:REFerence](#)" on page 461
 - "[:TIMEbase:RANGe](#)" on page 459
 - "[:TIMEbase:SCALE](#)" on page 462
 - "[:TIMEbase:WINDow:POSition](#)" on page 464
 - "[:TIMEbase:DELay](#)" on page 737

:TIMEbase:RANGe

C (see [page 786](#))

Command Syntax :TIMEbase:RANGe <range_value>

<range_value> ::= 5 ns through 500 s in NR3 format

The :TIMEbase:RANGe command sets the full-scale horizontal time in seconds for the main window. The range is 10 times the current time-per-division setting.

Query Syntax :TIMEbase:RANGe?

The :TIMEbase:RANGe query returns the current full-scale range value for the main window.

Return Format <range_value><NL>

<range_value> ::= 5 ns through 500 s in NR3 format

- See Also**
- ["Introduction to :TIMEbase Commands"](#) on page 456
 - [":TIMEbase:MODE"](#) on page 457
 - [":TIMEbase:SCALE"](#) on page 462
 - [":TIMEbase:WINDow:RANGe"](#) on page 465

Example Code

```
' TIME_RANGE - Sets the full scale horizontal time in seconds. The
' range value is 10 times the time per division.
myScope.WriteString ":TIM:RANG 2e-3" ' Set the time range to 0.002
seconds.
```

Example program from the start: ["VISA COM Example in Visual Basic"](#) on page 812

:TIMebase:REFClock

N (see [page 786](#))

Command Syntax :TIMebase:REFClock <value>
<value> ::= {{1 | ON} | {0 | OFF}}

The :TIMebase:REFClock command enables or disables the 10 MHz REF BNC located on the rear panel of the oscilloscope.

The 10 MHz REF BNC can be used as an input for the oscilloscope's reference clock (instead of the internal 10 MHz reference), or it can be used to output the internal 10 MHz reference clock when synchronizing multiple instruments (see [":ACQUIRE:RSIGNAL"](#) on page 189).

The :TIMebase:REFClock ON command enables the 10 MHz REF BNC and sets the reference signal mode to IN. The :TIMebase:REFClock OFF command disables the 10 MHz REF BNC (the same as setting the reference signal mode to OFF).

Query Syntax :TIMebase:REFClock?

The :TIMebase:REFClock? query returns the current state of the 10 MHz reference signal mode. A "1" indicates that the 10 MHz REF input is enabled (on), and a "0" indicates that either the 10 MHz REF BNC is disabled (off) or that it is set as an output (by the [:ACQUIRE:RSIGNAL](#) command).

Return Format <value><NL>
<value> ::= {0 | 1}

See Also • [":ACQUIRE:RSIGNAL"](#) on page 189

:TIMEbase:REFErence

C (see [page 786](#))

Command Syntax :TIMEbase:REFErence <reference>

<reference> ::= {LEFT | CENTer | RIGHT}

The :TIMEbase:REFErence command sets the time reference to one division from the left side of the screen, to the center of the screen, or to one division from the right side of the screen. Time reference is the point on the display where the trigger point is referenced.

Query Syntax :TIMEbase:REFErence?

The :TIMEbase:REFErence? query returns the current display reference for the main window.

Return Format <reference><NL>

<reference> ::= {LEFT | CENT | RIGH}

- See Also**
- ["Introduction to :TIMEbase Commands"](#) on page 456
 - [":TIMEbase:MODE"](#) on page 457

Example Code

```
' TIME_REFERENCE - Possible values are LEFT and CENTER.
' - LEFT sets the display reference on time division from the left.
' - CENTER sets the display reference to the center of the screen.
myScope.WriteString ":TIMEBASE:REFERENCE CENTER" ' Set reference to
center.
```

Example program from the start: ["VISA COM Example in Visual Basic"](#) on page 812

:TIMEbase:SCALE

N (see [page 786](#))

Command Syntax :TIMEbase:SCALE <scale_value>

<scale_value> ::= 500 ps through 50 s in NR3 format

The :TIMEbase:SCALE command sets the horizontal scale or units per division for the main window.

Query Syntax :TIMEbase:SCALE?

The :TIMEbase:SCALE? query returns the current horizontal scale setting in seconds per division for the main window.

Return Format <scale_value><NL>

<scale_value> ::= 500 ps through 50 s in NR3 format

- See Also**
- "[Introduction to :TIMEbase Commands](#)" on [page 456](#)
 - "[:TIMEbase:RANGE](#)" on [page 459](#)
 - "[:TIMEbase:WINDOW:SCALE](#)" on [page 466](#)
 - "[:TIMEbase:WINDOW:RANGE](#)" on [page 465](#)

:TIMEbase:VERNier

N (see [page 786](#))

Command Syntax :TIMEbase:VERNier <vernier value>
<vernier value> ::= {{1 | ON} | {0 | OFF}}

The :TIMEbase:VERNier command specifies whether the time base control's vernier (fine horizontal adjustment) setting is ON (1) or OFF (0).

Query Syntax :TIMEbase:VERNier?

The :TIMEbase:VERNier? query returns the current state of the time base control's vernier setting.

Return Format <vernier value><NL>
<vernier value> ::= {0 | 1}

See Also • ["Introduction to :TIMEbase Commands"](#) on page 456

:TIMebase:WINDow:POSition

C (see [page 786](#))

Command Syntax :TIMebase:WINDow:POSition <pos value>

<pos value> ::= time from the trigger event to the zoomed (delayed) view reference point in NR3 format

The :TIMebase:WINDow:POSition command sets the horizontal position in the zoomed (delayed) view of the main sweep. The main sweep range and the main sweep horizontal position determine the range for this command. The value for this command must keep the zoomed view window within the main sweep range.

Query Syntax :TIMebase:WINDow:POSition?

The :TIMebase:WINDow:POSition? query returns the current horizontal window position setting in the zoomed view.

Return Format <value><NL>

<value> ::= position value in seconds

- See Also**
- ["Introduction to :TIMebase Commands"](#) on page 456
 - [":TIMebase:MODE"](#) on page 457
 - [":TIMebase:POSition"](#) on page 458
 - [":TIMebase:RANGe"](#) on page 459
 - [":TIMebase:SCALe"](#) on page 462
 - [":TIMebase:WINDow:RANGe"](#) on page 465
 - [":TIMebase:WINDow:SCALe"](#) on page 466

:TIMebase:WINDow:RANGe

C (see [page 786](#))

Command Syntax :TIMebase:WINDow:RANGe <range value>

<range value> ::= range value in seconds in NR3 format

The :TIMebase:WINDow:RANGe command sets the full-scale horizontal time in seconds for the zoomed (delayed) window. The range is 10 times the current zoomed view window seconds per division setting. The main sweep range determines the range for this command. The maximum value is one half of the :TIMebase:RANGe value.

Query Syntax :TIMebase:WINDow:RANGe?

The :TIMebase:WINDow:RANGe? query returns the current window timebase range setting.

Return Format <value><NL>

<value> ::= range value in seconds

- See Also**
- ["Introduction to :TIMebase Commands"](#) on page 456
 - [":TIMebase:RANGe"](#) on page 459
 - [":TIMebase:POSition"](#) on page 458
 - [":TIMebase:SCALE"](#) on page 462

:TIMEbase:WINDow:SCALE

N (see [page 786](#))

Command Syntax :TIMEbase:WINDow:SCALE <scale_value>

<scale_value> ::= scale value in seconds in NR3 format

The :TIMEbase:WINDow:SCALE command sets the zoomed (delayed) window horizontal scale (seconds/division). The main sweep scale determines the range for this command. The maximum value is one half of the :TIMEbase:SCALE value.

Query Syntax :TIMEbase:WINDow:SCALE?

The :TIMEbase:WINDow:SCALE? query returns the current zoomed window scale setting.

Return Format <scale_value><NL>

<scale_value> ::= current seconds per division for the zoomed window

- See Also**
- ["Introduction to :TIMEbase Commands"](#) on page 456
 - [":TIMEbase:RANGE"](#) on page 459
 - [":TIMEbase:POSition"](#) on page 458
 - [":TIMEbase:SCALE"](#) on page 462
 - [":TIMEbase:WINDow:RANGE"](#) on page 465

:TRIGger Commands

Control the trigger modes and parameters for each trigger type. See:

- "Introduction to :TRIGger Commands" on page 467
- "General :TRIGger Commands" on page 470
- ":TRIGger:CAN Commands" on page 478
- ":TRIGger:DURation Commands" on page 489
- ":TRIGger:EBURst Commands" on page 495
- ":TRIGger[:EDGE] Commands" on page 499
- ":TRIGger:FLEXray Commands" on page 505
- ":TRIGger:GLITCh Commands" on page 517 (Pulse Width trigger)
- ":TRIGger:I2S Commands" on page 526
- ":TRIGger:IIC Commands" on page 544
- ":TRIGger:LIN Commands" on page 553
- ":TRIGger:M1553 Commands" on page 566
- ":TRIGger:SEQuence Commands" on page 573
- ":TRIGger:SPI Commands" on page 581
- ":TRIGger:TV Commands" on page 590
- ":TRIGger:USB Commands" on page 611
- ":TRIGger:UART Commands" on page 596

Introduction to :TRIGger Commands

The commands in the TRIGger subsystem define the conditions for an internal trigger. Many of these commands are valid in multiple trigger modes.

The default trigger mode is :EDGE.

The trigger subsystem controls the trigger sweep mode and the trigger specification. The trigger sweep (see ":TRIGger:SWEep" on page 477) can be AUTO or NORMal.

- **NORMal** mode – displays a waveform only if a trigger signal is present and the trigger conditions are met. Otherwise the oscilloscope does not trigger and the display is not updated. This mode is useful for low-repetitive-rate signals.
- **AUTO** trigger mode – generates an artificial trigger event if the trigger specification is not satisfied within a preset time, acquires unsynchronized data and displays it.

AUTO mode is useful for signals other than low-repetitive-rate signals. You must use this mode to display a DC signal because there are no edges on which to trigger.

The following trigger types are available (see `":TRIGger:MODE"` on page 473).

- **CAN (Controller Area Network) triggering**— will trigger on CAN version 2.0A and 2.0B signals. Setup consists of connecting the oscilloscope to a CAN signal. Baud rate, signal source, and signal polarity, and type of data to trigger on can be specified. With the automotive CAN and LIN serial decode option (Option ASM), you can also trigger on CAN data and identifier patterns, set the bit sample point, and have the module send an acknowledge to the bus when it receives a valid message.

NOTE

The CAN and LIN serial decode option (Option ASM) replaces the functionality that was available with the N2758A CAN trigger module for the 54620/54640 Series oscilloscopes.

- **Edge triggering**— identifies a trigger by looking for a specified slope and voltage level on a waveform.
- **Nth Edge Burst triggering**— lets you trigger on the Nth edge of a burst that occurs after an idle time.
- **Pulse width triggering**— (`:TRIGger:GLITch` commands) sets the oscilloscope to trigger on a positive pulse or on a negative pulse of a specified width.
- **Pattern triggering**— identifies a trigger condition by looking for a specified pattern. This pattern is a logical AND combination of the channels.
- **Duration triggering**— lets you define a pattern, then trigger on a specified time duration.
- **FlexRay triggering**— will, when used with a BusDoctor 2 protocol analyzer and a four-channel mixed-signal oscilloscope with Option FRS, trigger on FlexRay bus frames, times, or errors.
- **I2S (Inter-IC Sound or Integrated Interchip Sound bus) triggering**— consists of connecting the oscilloscope to the serial clock, word select, and serial data lines, then triggering on a data value.
- **IIC (Inter-IC bus) triggering**— consists of connecting the oscilloscope to the serial data (SDA) line and the serial clock (SCL) line, then triggering on a stop/start condition, a restart, a missing acknowledge, or on a read/write frame with a specific device address and data value.
- **LIN (Local Interconnect Network) triggering**— will trigger on LIN sync break at the beginning of a message frame. With the automotive CAN and LIN serial decode option (Option ASM), you can also trigger on Frame IDs.
- **MIL-STD 1553 triggering** (with Option 553) — lets you trigger on MIL-STD 1553 serial data.

- **Sequence triggering**– allows you to trigger the oscilloscope after finding a sequence of events. Defining a sequence trigger requires three steps:
 - a Define the event to find before you trigger on the next event. This event can be a pattern, and edge from a single channel, or the combination of a pattern and a channel edge.
 - b Define the trigger event. This event can be a pattern, and edge from a single channel, the combination of a pattern and a channel edge, or the nth occurrence of an edge from a single channel.
 - c Set an optional reset event. This event can be a pattern, an edge from a single channel, the combination of a pattern and a channel edge, or a timeout value.
- **SPI (Serial Peripheral Interface) triggering**– consists of connecting the oscilloscope to a clock, data, and framing signal. You can then trigger on a data pattern during a specific framing period. The serial data string can be specified to be from 4 to 32 bits long.
- **TV triggering**– is used to capture the complicated waveforms of television equipment. The trigger circuitry detects the vertical and horizontal interval of the waveform and produces triggers based on the TV trigger settings you selected. TV triggering requires greater than ^o division of sync amplitude with any analog channel as the trigger source.
- **UART/RS-232 triggering** (with Option 232) – lets you trigger on RS-232 serial data.
- **USB (Universal Serial Bus) triggering**– will trigger on a Start of Packet (SOP), End of Packet (EOP), Reset Complete, Enter Suspend, or Exit Suspend signal on the differential USB data lines. USB Low Speed and Full Speed are supported by this trigger.

Reporting the Setup

Use :TRIGger? to query setup information for the TRIGger subsystem.

Return Format

The return format for the TRIGger? query varies depending on the current mode. The following is a sample response from the :TRIGger? query. In this case, the query was issued following a *RST command.

```
:TRIG:MODE EDGE;SWE AUTO;NREJ 0;HFR 0;HOLD +60.0000000000000E-09;
:TRIG:EDGE:SOUR CHAN1;LEV +0.00000E+00;SLOP POS;REJ OFF;COUP DC
```

General :TRIGger Commands

Table 77 General :TRIGger Commands Summary

Command	Query	Options and Query Returns
:TRIGger:HFReject {{0 OFF} {1 ON}} (see page 471)	:TRIGger:HFReject? (see page 471)	{0 1}
:TRIGger:HOLDoff <holdoff_time> (see page 472)	:TRIGger:HOLDoff? (see page 472)	<holdoff_time> ::= 60 ns to 10 s in NR3 format
:TRIGger:MODE <mode> (see page 473)	:TRIGger:MODE? (see page 473)	<mode> ::= {EDGE GLITCh PATtern CAN DURation I2S IIC EBURst LIN M1553 SEQuence SPI TV UART USB FLEXray} <return_value> ::= {<mode> <none>} <none> ::= query returns "NONE" if the :TIMEbase:MODE is ROLL or XY
:TRIGger:NREJect {{0 OFF} {1 ON}} (see page 474)	:TRIGger:NREJect? (see page 474)	{0 1}
:TRIGger:PATtern <value>, <mask> [, <edge source>, <edge>] (see page 475)	:TRIGger:PATtern? (see page 476)	<value> ::= integer in NR1 format or <string> <mask> ::= integer in NR1 format or <string> <string> ::= "0xnxxxxn"; n ::= {0,...,9 A,...,F} (# bits = # channels) <edge source> ::= {CHANnel<n> EXTernal NONE} for DSO models <edge source> ::= {CHANnel<n> DIGital0,...,DIGital15 NONE} for MSO models <edge> ::= {POSitive NEGative} <n> ::= 1-2 or 1-4 in NR1 format
:TRIGger:SWEep <sweep> (see page 477)	:TRIGger:SWEep? (see page 477)	<sweep> ::= {AUTO NORMal}

:TRIGger:HFReject

C (see [page 786](#))

Command Syntax :TRIGger:HFReject <value>
 <value> ::= {{0 | OFF} | {1 | ON}}

The :TRIGger:HFReject command turns the high frequency reject filter off and on. The high frequency reject filter adds a 50 kHz low-pass filter in the trigger path to remove high frequency components from the trigger waveform. Use this filter to remove high-frequency noise, such as AM or FM broadcast stations, from the trigger path.

Query Syntax :TRIGger:HFReject?

The :TRIGger:HFReject? query returns the current high frequency reject filter mode.

Return Format <value><NL>
 <value> ::= {0 | 1}

- See Also**
- ["Introduction to :TRIGger Commands"](#) on page 467
 - [":TRIGger\[:EDGE\]:REJECT"](#) on page 502

:TRIGger:HOLDoff

C (see [page 786](#))

Command Syntax :TRIGger:HOLDoff <holdoff_time>
<holdoff_time> ::= 60 ns to 10 s in NR3 format

The :TRIGger:HOLDoff command defines the holdoff time value in seconds. Holdoff keeps a trigger from occurring until after a certain amount of time has passed since the last trigger. This feature is valuable when a waveform crosses the trigger level multiple times during one period of the waveform. Without holdoff, the oscilloscope could trigger on each of the crossings, producing a confusing waveform. With holdoff set correctly, the oscilloscope always triggers on the same crossing. The correct holdoff setting is typically slightly less than one period.

Query Syntax :TRIGger:HOLDoff?

The :TRIGger:HOLDoff? query returns the holdoff time value for the current trigger mode.

Return Format <holdoff_time><NL>
<holdoff_time> ::= the holdoff time value in seconds in NR3 format.

See Also • ["Introduction to :TRIGger Commands"](#) on page 467

:TRIGger:MODE

C (see [page 786](#))

Command Syntax :TRIGger:MODE <mode>

```
<mode> ::= {EDGE | GLITCh | PATTern | CAN | DURation | I2S | IIC
            | EBURst | LIN | M1553 | SEQuence | SPI | TV | UART
            | USB | FLEXray}
```

The :TRIGger:MODE command selects the trigger mode (trigger type).

Query Syntax :TRIGger:MODE?

The :TRIGger:MODE? query returns the current trigger mode. If the :TIMEbase:MODE is ROLL or XY, the query returns "NONE".

Return Format <mode><NL>

```
<mode> ::= {NONE | EDGE | GLIT | PATT | CAN | DUR | I2S
            | IIC | EBUR | LIN | M1553 | SEQ | SPI | TV | UART
            | USB | FLEX}
```

- See Also**
- ["Introduction to :TRIGger Commands" on page 467](#)
 - [":TRIGger:SWEep" on page 477](#)
 - [":TIMEbase:MODE" on page 457](#)

Example Code

```
' TRIGGER_MODE - Set the trigger mode to EDGE.
myScope.WriteString ":TRIGGER:MODE EDGE"
```

Example program from the start: ["VISA COM Example in Visual Basic" on page 812](#)

:TRIGger:NREJect

C (see [page 786](#))

Command Syntax :TRIGger:NREJect <value>
<value> ::= {{0 | OFF} | {1 | ON}}

The :TRIGger:NREJect command turns the noise reject filter off and on. When the noise reject filter is on, the trigger circuitry is less sensitive to noise but may require a greater amplitude waveform to trigger the oscilloscope. This command is not valid in TV trigger mode.

Query Syntax :TRIGger:NREJect?

The :TRIGger:NREJect? query returns the current noise reject filter mode.

Return Format <value><NL>
<value> ::= {0 | 1}

See Also • ["Introduction to :TRIGger Commands"](#) on page 467

:TRIGger:PATtern

C (see page 786)

Command Syntax :TRIGger:PATtern <pattern>
 <pattern> ::= <value>, <mask> [, <edge source>, <edge>]
 <value> ::= integer in NR1 format or <string>
 <mask> ::= integer in NR1 format or <string>
 <string> ::= "0xn timer"; n ::= {0,...,9 | A,...,F}
 (# bits = # channels, see following table)
 <edge source> ::= {CHANnel<n> | EXTERNAL | NONE} for DSO models
 <edge source> ::= {CHANnel<n> | DIGital0,...,DIGital15
 | NONE} for MSO models
 <n> ::= {1 | 2 | 3 | 4} for the four channel oscilloscope models
 <n> ::= {1 | 2} for the two channel oscilloscope models
 <edge> ::= {POSitive | NEGative}

The :TRIGger:PATtern command defines the specified pattern resource according to the value and the mask. For both <value> and <mask>, each bit corresponds to a possible trigger channel. The bit assignments vary by instrument:

Oscilloscope Models	Value and Mask Bit Assignments
4 analog + 16 digital channels (mixed-signal)	Bits 0 through 15 - digital channels 0 through 15. Bits 16 through 19 - analog channels 1 through 4.
2 analog + 16 digital channels (mixed-signal)	Bits 0 through 15 - digital channels 0 through 15. Bits 16 and 17 - analog channels 1 and 2.
4 analog channels only	Bits 0 through 3 - analog channels 1 through 4. Bit 4 - external trigger.
2 analog channels only	Bits 0 and 1 - analog channels 1 and 2. Bit 4 - external trigger.

Set a <value> bit to "0" to set the pattern for the corresponding channel to low. Set a <value> bit to "1" to set the pattern to high.

Set a <mask> bit to "0" to ignore the data for the corresponding channel. Only channels with a "1" set on the appropriate mask bit are used.

NOTE

The optional source and the optional edge should be sent together or not at all. The edge will be set in the simple pattern if it is included. If the edge source is also specified in the mask, the edge takes precedence.

5 Commands by Subsystem

Query Syntax `:TRIGger:PATtern?`

The `:TRIGger:PATtern?` query returns the pattern value, the mask, and the edge of interest in the simple pattern.

Return Format `<pattern><NL>`

- See Also**
- ["Introduction to :TRIGger Commands"](#) on page 467
 - [":TRIGger:MODE"](#) on page 473

:TRIGger:SWEEp

C (see [page 786](#))

Command Syntax :TRIGger:SWEEp <sweep>
 <sweep> ::= {AUTO | NORMAl}

The :TRIGger:SWEEp command selects the trigger sweep mode.

When AUTO sweep mode is selected, a baseline is displayed in the absence of a signal. If a signal is present but the oscilloscope is not triggered, the unsynchronized signal is displayed instead of a baseline.

When NORMAl sweep mode is selected and no trigger is present, the instrument does not sweep, and the data acquired on the previous trigger remains on the screen.

NOTE

This feature is called "Mode" on the instrument's front panel.

Query Syntax :TRIGger:SWEEp?

The :TRIGger:SWEEp? query returns the current trigger sweep mode.

Return Format <sweep><NL>
 <sweep> ::= current trigger sweep mode

See Also • ["Introduction to :TRIGger Commands"](#) on page 467

:TRIGger:CAN Commands

Table 78 :TRIGger:CAN Commands Summary

Command	Query	Options and Query Returns
:TRIGger:CAN:PATtern:DATA <value>, <mask> (see page 480)	:TRIGger:CAN:PATtern:DATA? (see page 480)	<value> ::= 64-bit integer in decimal, <nondecimal>, or <string> (with Option AMS) <mask> ::= 64-bit integer in decimal, <nondecimal>, or <string> <nondecimal> ::= #Hnn...n where n ::= {0,...,9 A,...,F} for hexadecimal <nondecimal> ::= #Bnn...n where n ::= {0 1} for binary <string> ::= "0xnn...n" where n ::= {0,...,9 A,...,F} for hexadecimal
:TRIGger:CAN:PATtern:DATA:LENGth <length> (see page 481)	:TRIGger:CAN:PATtern:DATA:LENGth? (see page 481)	<length> ::= integer from 1 to 8 in NR1 format (with Option AMS)
:TRIGger:CAN:PATtern:ID <value>, <mask> (see page 482)	:TRIGger:CAN:PATtern:ID? (see page 482)	<value> ::= 32-bit integer in decimal, <nondecimal>, or <string> (with Option AMS) <mask> ::= 32-bit integer in decimal, <nondecimal>, or <string> <nondecimal> ::= #Hnn...n where n ::= {0,...,9 A,...,F} for hexadecimal <nondecimal> ::= #Bnn...n where n ::= {0 1} for binary <string> ::= "0xnn...n" where n ::= {0,...,9 A,...,F} for hexadecimal
:TRIGger:CAN:PATtern:ID:MODE <value> (see page 483)	:TRIGger:CAN:PATtern:ID:MODE? (see page 483)	<value> ::= {STANdard EXTended} (with Option AMS)
:TRIGger:CAN:SAMPlepo int <value> (see page 484)	:TRIGger:CAN:SAMPlepo int? (see page 484)	<value> ::= {60 62.5 68 70 75 80 87.5} in NR3 format
:TRIGger:CAN:SIGNal:BAUdRate <baudrate> (see page 485)	:TRIGger:CAN:SIGNal:BAUdRate? (see page 485)	<baudrate> ::= integer from 10000 to 1000000 in 100 b/s increments

Table 78 :TRIGger:CAN Commands Summary (continued)

Command	Query	Options and Query Returns
:TRIGger:CAN:SOURce <source> (see page 486)	:TRIGger:CAN:SOURce? (see page 486)	<source> ::= {CHANnel<n> EXTernal} for DSO models <source> ::= {CHANnel<n> DIGital0,...,DIGital15 } for MSO models <n> ::= 1-2 or 1-4 in NR1 format
:TRIGger:CAN:TRIGger <condition> (see page 487)	:TRIGger:CAN:TRIGger? (see page 488)	<condition> ::= {SOF} (without Option AMS) <condition> ::= {SOF DATA ERRor IDData IDEither IDRemote ALLerrors OVERload ACKerror} (with Option AMS)

:TRIGger:CAN:PATtern:DATA

N (see [page 786](#))

Command Syntax :TRIGger:CAN:PATtern:DATA <value>,<mask>
 <value> ::= 64-bit integer in decimal, <nondecimal>, or <string>
 <mask> ::= 64-bit integer in decimal, <nondecimal>, or <string>
 <nondecimal> ::= #Hnn...n where n ::= {0,...,9 | A,...,F} for hexadecimal
 <nondecimal> ::= #Bnn...n where n ::= {0 | 1} for binary
 <string> ::= "0xnn...n" where n ::= {0,...,9 | A,...,F} for hexadecimal

The :TRIGger:CAN:PATtern:DATA command defines the CAN data pattern resource according to the value and the mask. This pattern, along with the data length (set by the :TRIGger:CAN:PATtern:DATA:LENGth command), control the data pattern searched for in each CAN message.

Set a <value> bit to "0" to set the corresponding bit in the data pattern to low. Set a <value> bit to "1" to set the bit to high.

Set a <mask> bit to "0" to ignore that bit in the data stream. Only bits with a "1" set on the mask are used.

NOTE

If more bytes are sent for <value> or <mask> than specified by the :TRIGger:CAN:PATtern:DATA:LENGth command, the most significant bytes will be truncated. If the data length is changed after the <value> and <mask> are programmed, the added or deleted bytes will be added to or deleted from the least significant bytes.

NOTE

This command is only valid when the automotive CAN and LIN serial decode option (Option AMS) has been licensed.

Query Syntax :TRIGger:CAN:PATtern:DATA?

The :TRIGger:CAN:PATtern:DATA? query returns the current settings of the specified CAN data pattern resource.

Return Format <value>,<mask><NL> in nondecimal format

Errors • ["-241, Hardware missing"](#) on [page 745](#)

See Also • ["Introduction to :TRIGger Commands"](#) on [page 467](#)
 • [":TRIGger:CAN:PATtern:DATA:LENGth"](#) on [page 481](#)
 • [":TRIGger:CAN:PATtern:ID"](#) on [page 482](#)

:TRIGger:CAN:PATtern:DATA:LENGth

N (see [page 786](#))

Command Syntax :TRIGger:CAN:PATtern:DATA:LENGth <length>

<length> ::= integer from 1 to 8 in NR1 format

The :TRIGger:CAN:PATtern:DATA:LENGth command sets the number of 8-bit bytes in the CAN data string. The number of bytes in the string can be anywhere from 0 bytes to 8 bytes (64 bits). The value for these bytes is set by the :TRIGger:CAN:PATtern:DATA command.

NOTE

This command is only valid when the automotive CAN and LIN serial decode option (Option AMS) has been licensed.

Query Syntax :TRIGger:CAN:PATtern:DATA:LENGth?

The :TRIGger:CAN:PATtern:DATA:LENGth? query returns the current CAN data pattern length setting.

Return Format <count><NL>

<count> ::= integer from 1 to 8 in NR1 format

Errors • ["-241, Hardware missing"](#) on [page 745](#)

See Also • ["Introduction to :TRIGger Commands"](#) on [page 467](#)
 • [":TRIGger:CAN:PATtern:DATA"](#) on [page 480](#)
 • [":TRIGger:CAN:SOURce"](#) on [page 486](#)

:TRIGger:CAN:PATtern:ID

N (see [page 786](#))

Command Syntax :TRIGger:CAN:PATtern:ID <value>, <mask>

<value> ::= 32-bit integer in decimal, <nondecimal>, or <string>

<mask> ::= 32-bit integer in decimal, <nondecimal>, or <string>

<nondecimal> ::= #Hnn...n where n ::= {0,...,9 | A,...,F} for hexadecimal

<nondecimal> ::= #Bnn...n where n ::= {0 | 1} for binary

<string> ::= "0xnn...n" where n ::= {0,...,9 | A,...,F} for hexadecimal

The :TRIGger:CAN:PATtern:ID command defines the CAN identifier pattern resource according to the value and the mask. This pattern, along with the identifier mode (set by the :TRIGger:CAN:PATtern:ID:MODE command), control the identifier pattern searched for in each CAN message.

Set a <value> bit to "0" to set the corresponding bit in the identifier pattern to low. Set a <value> bit to "1" to set the bit to high.

Set a <mask> bit to "0" to ignore that bit in the identifier stream. Only bits with a "1" set on the mask are used.

NOTE

If more bits are sent than allowed (11 bits in standard mode, 29 bits in extended mode) by the :TRIGger:CAN:PATtern:ID:MODE command, the most significant bytes will be truncated. If the ID mode is changed after the <value> and <mask> are programmed, the added or deleted bits will be added to or deleted from the most significant bits.

NOTE

This command is only valid when the automotive CAN and LIN serial decode option (Option AMS) has been licensed.

Query Syntax :TRIGger:CAN:PATtern:ID?

The :TRIGger:CAN:PATtern:ID? query returns the current settings of the specified CAN identifier pattern resource.

Return Format <value>, <mask><NL> in nondecimal format

Errors

- "-241, Hardware missing" on [page 745](#)

See Also

- "[Introduction to :TRIGger Commands](#)" on [page 467](#)
- ":TRIGger:CAN:PATtern:ID:MODE" on [page 483](#)
- ":TRIGger:CAN:PATtern:DATA" on [page 480](#)

:TRIGger:CAN:PATtern:ID:MODE

N (see [page 786](#))

Command Syntax :TRIGger:CAN:PATtern:ID:MODE <value>
 <value> ::= {STANdard | EXTended}

The :TRIGger:CAN:PATtern:ID:MODE command sets the CAN identifier mode. STANdard selects the standard 11-bit identifier. EXTended selects the extended 29-bit identifier. The CAN identifier is set by the :TRIGger:CAN:PATtern:ID command.

NOTE

This command is only valid when the automotive CAN and LIN serial decode option (Option AMS) has been licensed.

Query Syntax :TRIGger:CAN:PATtern:ID:MODE?

The :TRIGger:CAN:PATtern:ID:MODE? query returns the current setting of the CAN identifier mode.

Return Format <value><NL>
 <value> ::= {STAN | EXT}

Errors • "-241, Hardware missing" on [page 745](#)

See Also • ["Introduction to :TRIGger Commands"](#) on [page 467](#)
 • [":TRIGger:MODE"](#) on [page 473](#)
 • [":TRIGger:CAN:PATtern:DATA"](#) on [page 480](#)
 • [":TRIGger:CAN:PATtern:DATA:LENGth"](#) on [page 481](#)
 • [":TRIGger:CAN:PATtern:ID"](#) on [page 482](#)

:TRIGger:CAN:SAMPlEpoint

N (see [page 786](#))

Command Syntax :TRIGger:CAN:SAMPlEpoint <value>
<value><NL>

<value> ::= {60 | 62.5 | 68 | 70 | 75 | 80 | 87.5} in NR3 format

The :TRIGger:CAN:SAMPlEpoint command sets the point during the bit time where the bit level is sampled to determine whether the bit is dominant or recessive. The sample point represents the percentage of time between the beginning of the bit time to the end of the bit time.

Query Syntax :TRIGger:CAN:SAMPlEpoint?

The :TRIGger:CAN:SAMPlEpoint? query returns the current CAN sample point setting.

Return Format <value><NL>

<value> ::= {60 | 62.5 | 68 | 70 | 75 | 80 | 87.5} in NR3 format

- See Also**
- ["Introduction to :TRIGger Commands"](#) on page 467
 - [":TRIGger:MODE"](#) on page 473
 - [":TRIGger:CAN:TRIGger"](#) on page 487

:TRIGger:CAN:SIGNa:BAUDrate

N (see [page 786](#))

Command Syntax :TRIGger:CAN:SIGNa:BAUDrate <baudrate>

<baudrate> ::= integer from 10000 to 1000000 in 100 b/s increments

The :TRIGger:CAN:SIGNa:BAUDrate command sets the standard baud rate of the CAN signal from 10 kb/s to 1 Mb/s in 100 b/s increments. If you enter a baud rate that is not divisible by 100 b/s, the baud rate is set to the nearest baud rate divisible by 100 b/s.

If the baud rate you select does not match the system baud rate, false triggers may occur.

Query Syntax :TRIGger:CAN:SIGNa:BAUDrate?

The :TRIGger:CAN:SIGNa:BAUDrate? query returns the current CAN baud rate setting.

Return Format <baudrate><NL>

<baudrate> ::= integer from 10000 to 1000000 in 100 b/s increments

- See Also**
- ["Introduction to :TRIGger Commands"](#) on page 467
 - [":TRIGger:MODE"](#) on page 473
 - [":TRIGger:CAN:TRIGger"](#) on page 487
 - [":TRIGger:CAN:SIGNa:DEFinition"](#) on page 739
 - [":TRIGger:CAN:SOURce"](#) on page 486

:TRIGger:CAN:SOURce

N (see [page 786](#))

Command Syntax :TRIGger:CAN:SOURce <source>

<source> ::= {CHANnel<n> | EXTernal} for the DSO models

<source> ::= {CHANnel<n> | DIGital0,...,DIGital15} for the MSO models

<n> ::= {1 | 2 | 3 | 4} for the four channel oscilloscope models

<n> ::= {1 | 2} for the two channel oscilloscope models

The :TRIGger:CAN:SOURce command sets the source for the CAN signal. The source setting is only valid when :TRIGger:CAN:TRIGger is set to SOF (start of frame).

Query Syntax :TRIGger:CAN:SOURce?

The :TRIGger:CAN:SOURce? query returns the current source for the CAN signal.

Return Format <source><NL>

- See Also**
- ["Introduction to :TRIGger Commands"](#) on page 467
 - [":TRIGger:MODE"](#) on page 473
 - [":TRIGger:CAN:TRIGger"](#) on page 487
 - [":TRIGger:CAN:SIGNal:DEFinition"](#) on page 739

:TRIGger:CAN:TRIGger

N (see page 786)

Command Syntax :TRIGger:CAN:TRIGger <condition>

```
<condition> ::= {SOF | DATA | ERRor | IDData | IDEither | IDRemote |
                ALLerrors | OVERload | ACKerror}
```

The :TRIGger:CAN:TRIGger command sets the CAN trigger on condition:

- SOF - will trigger on the Start of Frame (SOF) bit of a Data frame, Remote Transfer Request (RTR) frame, or an Overload frame.
- DATA - will trigger on CAN Data frames matching the specified Id, Data, and the DLC (Data length code).
- ERRor - will trigger on CAN Error frame.
- IDData - will trigger on CAN frames matching the specified Id of a Data frame.
- IDEither - will trigger on the specified Id, regardless if it is a Remote frame or a Data frame.
- IDRemote - will trigger on CAN frames matching the specified Id of a Remote frame.
- ALLerrors - will trigger on CAN active error frames and unknown bus conditions.
- OVERload - will trigger on CAN overload frames.
- ACKerror - will trigger on a data or remote frame acknowledge bit that is recessive.

The table below shows the programming parameter and the corresponding front-panel softkey selection:

Remote <condition> parameter	Front-panel Trigger on: softkey selection (softkey text - softkey popup text)
SOF	SOF - Start of Frame
DATA	Id & Data - Data Frame Id and Data
ERRor	Error - Error frame
IDData	Id & ~RTR - Data Frame Id (~RTR)
IDEither	Id - Remote or Data Frame Id
IDRemote	Id & RTR - Remote Frame Id (RTR)
ALLerrors	All Errors - All Errors
OVERload	Overload - Overload Frame
ACKerror	Ack Error - Acknowledge Error

CAN Id specification is set by the `:TRIGger:CAN:PATtern:ID` and `:TRIGger:CAN:PATtern:ID:MODE` commands.

CAN Data specification is set by the `:TRIGger:CAN:PATtern:DATA` command.

CAN Data Length Code is set by the `:TRIGger:CAN:PATtern:DATA:LENGth` command.

NOTE

SOF is the only valid selection for analog oscilloscopes. If the automotive CAN and LIN serial decode option (Option AMS) has not been licensed, SOF is the only valid selection.

Query Syntax `:TRIGger:CAN:TRIGger?`

The `:TRIGger:CAN:TRIGger?` query returns the current CAN trigger on condition.

Return Format `<condition><NL>`

`<condition> ::= {SOF | DATA | ERR | IDD | IDE | IDR | ALL | OVER | ACK}`

Errors

- ["-241, Hardware missing"](#) on page 745

See Also

- ["Introduction to :TRIGger Commands"](#) on page 467
- [":TRIGger:MODE"](#) on page 473
- [":TRIGger:CAN:PATtern:DATA"](#) on page 480
- [":TRIGger:CAN:PATtern:DATA:LENGth"](#) on page 481
- [":TRIGger:CAN:PATtern:ID"](#) on page 482
- [":TRIGger:CAN:PATtern:ID:MODE"](#) on page 483
- [":TRIGger:CAN:SIGNal:DEFinition"](#) on page 739
- [":TRIGger:CAN:SOURce"](#) on page 486

:TRIGger:DURation Commands

Table 79 :TRIGger:DURation Commands Summary

Command	Query	Options and Query Returns
:TRIGger:DURation:GREaterthan <greater than time>[suffix] (see page 490)	:TRIGger:DURation:GREaterthan? (see page 490)	<greater_than_time> ::= floating-point number in NR3 format [suffix] ::= {s ms us ns ps}
:TRIGger:DURation:LESSthan <less than time>[suffix] (see page 491)	:TRIGger:DURation:LESSthan? (see page 491)	<less_than_time> ::= floating-point number from in NR3 format [suffix] ::= {s ms us ns ps}
:TRIGger:DURation:PATTERN <value>, <mask> (see page 492)	:TRIGger:DURation:PATTERN? (see page 492)	<value> ::= integer or <string> <mask> ::= integer or <string> <string> ::= "0xnxxxxxxx" n ::= {0,...,9 A,...,F}
:TRIGger:DURation:QUALifier <qualifier> (see page 493)	:TRIGger:DURation:QUALifier? (see page 493)	<qualifier> ::= {GREaterthan LESSthan INRange OUTRange TIMEout}
:TRIGger:DURation:RANGE <less_than_time>[suffix], <greater_than_time>[suffix] (see page 494)	:TRIGger:DURation:RANGE? (see page 494)	<less_than_time> ::= 15 ns to 10 seconds in NR3 format <greater_than_time> ::= 10 ns to 9.99 seconds in NR3 format [suffix] ::= {s ms us ns ps}

:TRIGger:DURation:GREaterthan

N (see [page 786](#))

Command Syntax :TRIGger:DURation:GREaterthan <greater_than_time> [<suffix>]
<greater_than_time> ::= minimum trigger duration in seconds
in NR3 format
<suffix> ::= {s | ms | us | ns | ps }

The :TRIGger:DURation:GREaterthan command sets the minimum duration for the defined pattern when :TRIGger:DURation:QUALifier is set to GREaterthan. The command also sets the timeout value when the :TRIGger:DURation:QUALifier is set to TIMEout.

Query Syntax :TRIGger:DURation:GREaterthan?

The :TRIGger:DURation:GREaterthan? query returns the minimum duration time for the defined pattern.

Return Format <greater_than_time><NL>

- See Also**
- "[Introduction to :TRIGger Commands](#)" on page 467
 - "[:TRIGger:DURation:PATtern](#)" on page 492
 - "[:TRIGger:DURation:QUALifier](#)" on page 493
 - "[:TRIGger:MODE](#)" on page 473

:TRIGger:DURation:LESSthan

N (see [page 786](#))

Command Syntax :TRIGger:DURation:LESSthan <less_than_time>[<suffix>]
 <less_than_time> ::= maximum trigger duration in seconds
 in NR3 format
 <suffix> ::= {s | ms | us | ns | ps}

The :TRIGger:DURation:LESSthan command sets the maximum duration for the defined pattern when :TRIGger:DURation:QUALifier is set to LESSthan.

Query Syntax :TRIGger:DURation:LESSthan?

The :TRIGger:DURation:LESSthan? query returns the duration time for the defined pattern.

Return Format <less_than_time><NL>

- See Also**
- "[Introduction to :TRIGger Commands](#)" on page 467
 - "[:TRIGger:DURation:PATtern](#)" on page 492
 - "[:TRIGger:DURation:QUALifier](#)" on page 493
 - "[:TRIGger:MODE](#)" on page 473

:TRIGger:DURation:PATtern

N (see [page 786](#))

Command Syntax :TRIGger:DURation:PATtern <value>, <mask>
 <value> ::= integer or <string>
 <mask> ::= integer or <string>
 <string> ::= "0xnmmnnn"; n ::= {0,...,9 | A,...,F}

The :TRIGger:DURation:PATtern command defines the specified duration pattern resource according to the value and the mask. For both <value> and <mask>, each bit corresponds to a possible trigger channel. The bit assignments vary by instrument:

Oscilloscope Models	Value and Mask Bit Assignments
4 analog + 16 digital channels (mixed-signal)	Bits 0 through 15 - digital channels 0 through 15. Bits 16 through 19 - analog channels 1 through 4.
2 analog + 16 digital channels (mixed-signal)	Bits 0 through 15 - digital channels 0 through 15. Bits 16 and 17 - analog channels 1 and 2.
4 analog channels only	Bits 0 through 3 - analog channels 1 through 4. Bit 4 - external trigger.
2 analog channels only	Bits 0 and 1 - analog channels 1 and 2. Bit 4 - external trigger.

Set a <value> bit to "0" to set the pattern for the corresponding channel to low. Set a <value> bit to "1" to set the pattern to high.

Set a <mask> bit to "0" to ignore the data for the corresponding channel. Only channels with a "1" set on the appropriate mask bit are used.

Query Syntax :TRIGger:DURation:PATtern?

The :TRIGger:DURation:PATtern? query returns the pattern value.

Return Format <value>, <mask><NL>
 <value> ::= a 32-bit integer in NR1 format.
 <mask> ::= a 32-bit integer in NR1 format.

See Also

- "[Introduction to :TRIGger Commands](#)" on page 467
- "[:TRIGger:PATtern](#)" on page 475

:TRIGger:DURation:QUALifier

N (see [page 786](#))

Command Syntax :TRIGger:DURation:QUALifier <qualifier>

<qualifier> ::= {GREaterthan | LESSthan | INRange | OUTRange | TIMEout}

The :TRIGger:DURation:QUALifier command qualifies the trigger duration.

Set the GREaterthan qualifier value with the :TRIGger:DURation:GREaterthan command.

Set the LESSthan qualifier value with the :TRIGger:DURation:LESSthan command.

Set the INRange and OUTRange qualifier values with the :TRIGger:DURation:RANGE command.

Set the TIMEout qualifier value with the :TRIGger:DURation:GREaterthan command.

Query Syntax :TRIGger:DURation:QUALifier?

The :TRIGger:DURation:QUALifier? query returns the trigger duration qualifier.

Return Format <qualifier><NL>

- See Also**
- ["Introduction to :TRIGger Commands"](#) on page 467
 - [":TRIGger:DURation:GREaterthan"](#) on page 490
 - [":TRIGger:DURation:LESSthan"](#) on page 491
 - [":TRIGger:DURation:RANGE"](#) on page 494

:TRIGger:EBURst Commands

Table 80 :TRIGger:EBURst Commands Summary

Command	Query	Options and Query Returns
:TRIGger:EBURst:COUNT <count> (see page 496)	:TRIGger:EBURst:COUNT ? (see page 496)	<count> ::= integer in NR1 format
:TRIGger:EBURst:IDLE <time_value> (see page 497)	:TRIGger:EBURst:IDLE? (see page 497)	<time_value> ::= time in seconds in NR3 format
:TRIGger:EBURst:SLOPe <slope> (see page 498)	:TRIGger:EBURst:SLOPe ? (see page 498)	<slope> ::= {NEGative POSitive}

The :TRIGger:EDGE:SOURce command is used to specify the source channel for the Nth Edge Burst trigger. If an analog channel is selected as the source, the :TRIGger:EDGE:LEVel command is used to set the Nth Edge Burst trigger level. If a digital channel is selected as the source, the :DIGital<n>:THReshold or :POD<n>:THReshold command is used to set the Nth Edge Burst trigger level.

:TRIGger:EBURst:COUNT

N (see [page 786](#))

Command Syntax :TRIGger:EBURst:COUNT <count>

<count> ::= integer in NR1 format

The :TRIGger:EBURst:COUNT command sets the Nth edge at burst counter resource. The edge counter is used in the trigger stage to determine which edge in a burst will generate a trigger.

Query Syntax :TRIGger:EBURst:COUNT?

The :TRIGger:EBURst:COUNT? query returns the current Nth edge of burst edge counter setting.

Return Format <count><NL>

<count> ::= integer in NR1 format

- See Also**
- "[Introduction to :TRIGger Commands](#)" on page 467
 - "[:TRIGger:EBURst:SLOPe](#)" on page 498
 - "[:TRIGger:EBURst:IDLE](#)" on page 497

:TRIGger:EBURst:IDLE

N (see [page 786](#))

Command Syntax :TRIGger:EBURst:IDLE <time_value>

<time_value> ::= time in seconds in NR3 format

The :TRIGger:EBURst:IDLE command sets the Nth edge in a burst idle resource in seconds from 10 ns to 10 s. The timer is used to set the minimum time before the next burst.

Query Syntax :TRIGger:EBURst:IDLE?

The :TRIGger:EBURst:IDLE? query returns current Nth edge in a burst idle setting.

Return Format <time value><NL>

<time_value> ::= time in seconds in NR3 format

- See Also**
- "[Introduction to :TRIGger Commands](#)" on page 467
 - "[:TRIGger:EBURst:SLOPe](#)" on page 498
 - "[:TRIGger:EBURst:COUnT](#)" on page 496

:TRIGger:EBURst:SLOPe

N (see [page 786](#))

Command Syntax :TRIGger:EBURst:SLOPe <slope>

<slope> ::= {NEGative | POSitive}

The :TRIGger:EBURst:SLOPe command specifies whether the rising edge (POSitive) or falling edge (NEGative) of the Nth edge in a burst will generate a trigger.

Query Syntax :TRIGger:EBURst:SLOPe?

The :TRIGger:EBURst:SLOPe? query returns the current Nth edge in a burst slope.

Return Format <slope><NL>

<slope> ::= {NEG | POS}

- See Also**
- "[Introduction to :TRIGger Commands](#)" on page 467
 - "[:TRIGger:EBURst:IDLE](#)" on page 497
 - "[:TRIGger:EBURst:COUNT](#)" on page 496

:TRIGger[:EDGE] Commands

Table 81 :TRIGger[:EDGE] Commands Summary

Command	Query	Options and Query Returns
:TRIGger[:EDGE]:COUPling {AC DC LF} (see page 500)	:TRIGger[:EDGE]:COUPling? (see page 500)	{AC DC LF}
:TRIGger[:EDGE]:LEVel <level> [, <source>] (see page 501)	:TRIGger[:EDGE]:LEVel ? [<source>] (see page 501)	For internal triggers, <level> ::= .75 x full-scale voltage from center screen in NR3 format. For external triggers, <level> ::= ±(external range setting) in NR3 format. For digital channels (MSO models), <level> ::= ±8 V. <source> ::= {CHANnel<n> EXTernal} for DSO models <source> ::= {CHANnel<n> DIGital0,..,DIGital15 EXTernal} for MSO models <n> ::= 1-2 or 1-4 in NR1 format
:TRIGger[:EDGE]:REJect {OFF LF HF} (see page 502)	:TRIGger[:EDGE]:REJect? (see page 502)	{OFF LF HF}
:TRIGger[:EDGE]:SLOPe <polarity> (see page 503)	:TRIGger[:EDGE]:SLOPe ? (see page 503)	<polarity> ::= {POSitive NEGative EITHER ALTernate}
:TRIGger[:EDGE]:SOURC e <source> (see page 504)	:TRIGger[:EDGE]:SOURC e? (see page 504)	<source> ::= {CHANnel<n> EXTernal} for DSO models <source> ::= {CHANnel<n> DIGital0,..,DIGital15 EXTernal} for MSO models <n> ::= 1-2 or 1-4 in NR1 format

:TRIGger[:EDGE]:COUPLing

C (see [page 786](#))

Command Syntax :TRIGger[:EDGE]:COUPLing <coupling>
 <coupling> ::= {AC | DC | LFReject}

The :TRIGger[:EDGE]:COUPLing command sets the input coupling for the selected trigger sources. The coupling can be set to AC, DC, or LFReject.

- AC coupling places a high-pass filter (10 Hz for analog channels, and 3.5 Hz for all External trigger inputs) in the trigger path, removing dc offset voltage from the trigger waveform. Use AC coupling to get a stable edge trigger when your waveform has a large dc offset.
- LFReject coupling places a 50 KHz high-pass filter in the trigger path.
- DC coupling allows dc and ac signals into the trigger path.

NOTE

The :TRIGger[:EDGE]:COUPLing and the :TRIGger[:EDGE]:REJect selections are coupled. Changing the setting of the :TRIGger[:EDGE]:REJect can change the COUPLing setting.

Query Syntax :TRIGger[:EDGE]:COUPLing?

The :TRIGger[:EDGE]:COUPLing? query returns the current coupling selection.

Return Format <coupling><NL>
 <coupling> ::= {AC | DC | LFR}

- See Also**
- "[Introduction to :TRIGger Commands](#)" on page 467
 - "[:TRIGger:MODE](#)" on page 473
 - "[:TRIGger\[:EDGE\]:REJect](#)" on page 502

:TRIGger[:EDGE]:LEVel

C (see [page 786](#))

Command Syntax :TRIGger[:EDGE]:LEVel <level>
 <level> ::= <level>[,<source>]
 <level> ::= 0.75 x full-scale voltage from center screen in NR3 format
 for internal triggers
 <level> ::= ±(external range setting) in NR3 format
 for external triggers
 <level> ::= ±8 V for digital channels (MSO models)
 <source> ::= {CHANnel<n> | EXTernal} for the DSO models
 <source> ::= {CHANnel<n> | DIGital0,..,DIGital15 | EXTernal}
 for the MSO models
 <n> ::= {1 | 2 | 3 | 4} for the four channel oscilloscope models
 <n> ::= {1 | 2} for the two channel oscilloscope models

The :TRIGger[:EDGE]:LEVel command sets the trigger level voltage for the active trigger source.

NOTE

If the optional source is specified and is not the active source, the level on the active source is not affected and the active source is not changed.

Query Syntax :TRIGger[:EDGE]:LEVel? [<source>]

The :TRIGger[:EDGE]:LEVel? query returns the trigger level of the current trigger source.

Return Format <level><NL>

- See Also**
- "Introduction to :TRIGger Commands" on page 467
 - ":TRIGger[:EDGE]:SOURce" on page 504
 - ":EXTernal:RANGe" on page 262
 - ":POD<n>:THReshold" on page 395
 - ":DIGital<n>:THReshold" on page 243

:TRIGger[:EDGE]:REJect

C (see [page 786](#))

Command Syntax :TRIGger[:EDGE]:REJect <reject>
 <reject> ::= {OFF | LFReject | HFReject}

The :TRIGger[:EDGE]:REJect command turns the low-frequency or high-frequency reject filter on or off. You can turn on one of these filters at a time.

- The high frequency reject filter adds a 50 kHz low-pass filter in the trigger path to remove high frequency components from the trigger waveform. Use the high frequency reject filter to remove high-frequency noise, such as AM or FM broadcast stations, from the trigger path.
- The low frequency reject filter adds a 50 kHz high-pass filter in series with the trigger waveform to remove any unwanted low frequency components from a trigger waveform, such as power line frequencies, that can interfere with proper triggering.

NOTE

The :TRIGger[:EDGE]:REJect and the :TRIGger[:EDGE]:COUPling selections are coupled. Changing the setting of the :TRIGger[:EDGE]:COUPling can change the COUPling setting.

Query Syntax :TRIGger[:EDGE]:REJect?

The :TRIGger[:EDGE]:REJect? query returns the current status of the reject filter.

Return Format <reject><NL>
 <reject> ::= {OFF | LFR | HFR}

- See Also**
- "[Introduction to :TRIGger Commands](#)" on page 467
 - "[:TRIGger:HFReject](#)" on page 471
 - "[:TRIGger\[:EDGE\]:COUPling](#)" on page 500

:TRIGger[:EDGE]:SLOPe

C (see [page 786](#))

Command Syntax :TRIGger[:EDGE]:SLOPe <slope>

<slope> ::= {NEGative | POSitive | EITHer | ALTErnate}

The :TRIGger[:EDGE]:SLOPe command specifies the slope of the edge for the trigger. The SLOPe command is not valid in TV trigger mode. Instead, use :TRIGger:TV:POLarity to set the polarity in TV trigger mode.

Query Syntax :TRIGger[:EDGE]:SLOPe?

The :TRIGger[:EDGE]:SLOPe? query returns the current trigger slope.

Return Format <slope><NL>

<slope> ::= {NEG | POS | EITH | ALT}

- See Also**
- ["Introduction to :TRIGger Commands"](#) on page 467
 - [":TRIGger:MODE"](#) on page 473
 - [":TRIGger:TV:POLarity"](#) on page 593

Example Code

```
' TRIGGER_EDGE_SLOPE - Sets the slope of the edge for the trigger.
' Set the slope to positive.
myScope.WriteString ":TRIGGER:EDGE:SLOPE POSITIVE"
```

Example program from the start: ["VISA COM Example in Visual Basic"](#) on page 812

:TRIGger[:EDGE]:SOURce

C (see [page 786](#))

Command Syntax :TRIGger[:EDGE]:SOURce <source>

<source> ::= {CHANnel<n> | EXTernal | LINE} for the DSO models

<source> ::= {CHANnel<n> | DIGital0,...,DIGital15 | EXTernal | LINE}
for the MSO models

<n> ::= {1 | 2 | 3 | 4} for the four channel oscilloscope models

<n> ::= {1 | 2} for the two channel oscilloscope models

The :TRIGger[:EDGE]:SOURce command selects the channel that produces the trigger.

Query Syntax :TRIGger[:EDGE]:SOURce?

The :TRIGger[:EDGE]:SOURce? query returns the current source. If all channels are off, the query returns "NONE."

Return Format <source><NL>

<source> ::= {CHAN<n> | EXT | LINE | NONE} for the DSO models

<source> ::= {CHAN<n> | DIG0,...,DIG15 | EXTernal | LINE | NONE}
for the MSO models

- See Also**
- ["Introduction to :TRIGger Commands"](#) on page 467
 - [":TRIGger:MODE"](#) on page 473

Example Code

```
' TRIGGER_EDGE_SOURCE - Selects the channel that actually produces the
edge trigger. Any channel can be selected.
myScope.WriteString ":TRIGGER:EDGE:SOURCE CHANNEL1"
```

Example program from the start: ["VISA COM Example in Visual Basic"](#) on page 812

:TRIGger:FLEXray Commands

Table 82 :TRIGger:FLEXray Commands Summary

Command	Query	Options and Query Returns
:TRIGger:FLEXray:AUTOsetup (see page 506)	n/a	n/a
:TRIGger:FLEXray:BAUDrate <baudrate> (see page 507)	:TRIGger:FLEXray:BAUDrate? (see page 507)	<baudrate> ::= {2500000 5000000 10000000}
:TRIGger:FLEXray:CHANNEL <channel> (see page 508)	:TRIGger:FLEXray:CHANNEL? (see page 508)	<channel> ::= {A B}
:TRIGger:FLEXray:ERROR:TYPE <error_type> (see page 509)	:TRIGger:FLEXray:ERROR:TYPE? (see page 509)	<error_type> ::= {ALL HCRC FCRC}
:TRIGger:FLEXray:EVENT:TYPE <event> (see page 510)	:TRIGger:FLEXray:EVENT:TYPE? (see page 510)	<event> ::= {WAKEup TSS {FES DTS} BSS}
:TRIGger:FLEXray:FRAME:CBase <cycle_count_base> (see page 511)	:TRIGger:FLEXray:FRAME:CBase? (see page 511)	<cycle_count_base> ::= integer from 0-63
:TRIGger:FLEXray:FRAME:CRepetition <cycle_count_repetition> (see page 512)	:TRIGger:FLEXray:FRAME:CRepetition? (see page 512)	<cycle_count_repetition> ::= {ALL <rep #>} <rep #> ::= integer from 2-64
:TRIGger:FLEXray:FRAME:ID <frame_id> (see page 513)	:TRIGger:FLEXray:FRAME:ID? (see page 513)	<frame_id> ::= {ALL <frame #>} <frame #> ::= integer from 1-2047
:TRIGger:FLEXray:FRAME:TYPE <frame_type> (see page 514)	:TRIGger:FLEXray:FRAME:TYPE? (see page 514)	<frame_type> ::= {NORMAL STARTup NULL SYNC NSTARTup NNULL NSYNc ALL}
:TRIGger:FLEXray:SOURCE <source> (see page 515)	:TRIGger:FLEXray:SOURCE? (see page 515)	<source> ::= {CHANNEL<n>} <n> ::= 1-2 or 1-4 in NR1 format
:TRIGger:FLEXray:TRIGGER <condition> (see page 516)	:TRIGger:FLEXray:TRIGGER? (see page 516)	<condition> ::= {FRAME ERROR EVENT}

:TRIGger:FLEXray:AUTosetup

N (see [page 786](#))

Command Syntax :TRIGger:FLEXray:AUTosetup

The :TRIGger:FLEXray:AUTosetup command automatically configures oscilloscope settings to facilitate FlexRay triggering and serial decode.

- Sets the selected source channel's impedance to 50 Ohms.
- Sets the selected source channel's probe attenuation to 10:1.
- Sets the trigger level (on the selected source channel) to -300 mV.
- Turns on trigger Noise Reject.
- Turns on Serial Decode.
- Sets the trigger type to FlexRay.

NOTE

This command is only valid when the FLEXray triggering and serial decode option (Option FLX) has been licensed.

- See Also**
- "[Introduction to :TRIGger Commands](#)" on page 467
 - "[:TRIGger:FLEXray:TRIGger](#)" on page 516
 - "[:TRIGger:FLEXray:BAUDrate](#)" on page 507
 - "[:TRIGger\[:EDGE\]:LEVel](#)" on page 501
 - "[:TRIGger:FLEXray:SOURce](#)" on page 515

:TRIGger:FLEXray:BAUDrate

N (see [page 786](#))

Command Syntax :TRIGger:FLEXray:BAUDrate <baudrate>
 <baudrate> ::= {2500000 | 5000000 | 10000000}

The :TRIGger:FLEXray:BAUDrate command specifies the baud rate as 2.5 Mb/s, 5 Mb/s, or 10 Mb/s.

NOTE

This command is only valid on 4 (analog) channel oscilloscope models when the FlexRay triggering and serial decode option (Option FLX) has been licensed.

Query Syntax :TRIGger:FLEXray:BAUDrate?

The :TRIGger:FLEXray:BAUDrate? query returns the current baud rate setting.

Return Format <baudrate><NL>
 <baudrate> ::= {2500000 | 5000000 | 10000000}

- See Also**
- ["Introduction to :TRIGger Commands"](#) on page 467
 - [":TRIGger:FLEXray Commands"](#) on page 505

:TRIGger:FLEXray:CHANnel

N (see [page 786](#))

Command Syntax :TRIGger:FLEXray:CHANnel <channel>
<channel> ::= {A | B}

The :TRIGger:FLEXray:CHANnel command specifies the bus channel, A or B, of the FlexRay signal.

NOTE

This command is only valid on 4 (analog) channel oscilloscope models when the FlexRay triggering and serial decode option (Option FLX) has been licensed.

Query Syntax :TRIGger:FLEXray:CHANnel?

The :TRIGger:FLEXray:CHANnel? query returns the current bus channel setting.

Return Format <channel><NL>

<channel> ::= {A | B}

- See Also**
- ["Introduction to :TRIGger Commands"](#) on page 467
 - [":TRIGger:FLEXray Commands"](#) on page 505

:TRIGger:FLEXray:ERRor:TYPE

N (see [page 786](#))

Command Syntax :TRIGger:FLEXray:ERRor:TYPE <error_type>
 <error_type> ::= {ALL | HCRC | FCRC}

Selects the FlexRay error type to trigger on. The error type setting is only valid when the FlexRay trigger mode is set to ERROR.

- ALL – triggers on ALL errors.
- HCRC – triggers on only Header CRC errors.
- FCRC – triggers on only Frame CRC errors.

NOTE

This command is only valid when the FLEXray triggering and serial decode option (Option FLX) has been licensed.

Query Syntax :TRIGger:FLEXray:ERRor:TYPE?

The :TRIGger:FLEXray:ERRor:TYPE? query returns the currently selected FLEXray error type.

Return Format <error_type><NL>
 <error_type> ::= {ALL | HCRC | FCRC}

- See Also**
- ["Introduction to :TRIGger Commands"](#) on page 467
 - [":TRIGger:FLEXray:TRIGger"](#) on page 516

:TRIGger:FLEXray:EVENT:TYPE

N (see [page 786](#))

Command Syntax :TRIGger:FLEXray:EVENT:TYPE <event>

<event> ::= {WAKEup | TSS | {FES | DTS} | BSS}

Selects the FlexRay event to trigger on. The event setting is only valid when the FlexRay trigger mode is set to EVENT.

- WAKEup – triggers on Wake-Up event.
- TSS – triggers on Transmission Start Sequence event.
- FES – triggers on Frame End Sequence event.
- DTS – triggers on Dynamic Trailing Sequence event.
- BSS – triggers on Byte Start Sequence event.

NOTE

FES and DTS are equivalent.

NOTE

This command is only valid when the FLEXray triggering and serial decode option (Option FLX) has been licensed.

Query Syntax :TRIGger:FLEXray:EVENT:TYPE?

The :TRIGger:FLEXray:EVENT:TYPE? query returns the currently selected FLEXray event.

Return Format <event><NL>

<event> ::= {WAK | TSS | {FES | DTS} | BSS}

- See Also**
- ["Introduction to :TRIGger Commands"](#) on page 467
 - [":TRIGger:FLEXray:TRIGger"](#) on page 516
 - [":TRIGger:FLEXray:AUTOsetup"](#) on page 506
 - [":TRIGger:FLEXray:SOURce"](#) on page 515

:TRIGger:FLEXray:FRAME:CCBase

N (see [page 786](#))

Command Syntax :TRIGger:FLEXray:FRAME:CCBase <cycle_count_base>
 <cycle_count_base> ::= integer from 0-63

The :TRIGger:FLEXray:FRAME:CCBase command sets the base of the FlexRay cycle count (in the frame header) to trigger on. The cycle count base setting is only valid when the FlexRay trigger mode is set to FRAME.

NOTE

This command is only valid when the FlexRay triggering and serial decode option (Option FLX) has been licensed.

Query Syntax :TRIGger:FLEXray:FRAME:CCBase?

The :TRIGger:FLEXray:FRAME:CCBase? query returns the current cycle count base setting for the FlexRay frame trigger setup.

Return Format <cycle_count_base><NL>
 <cycle_count_base> ::= integer from 0-63

- See Also**
- ["Introduction to :TRIGger Commands"](#) on page 467
 - [":TRIGger:FLEXray:TRIGger"](#) on page 516

:TRIGger:FLEXray:FRAME:CCRepetition

N (see [page 786](#))

Command Syntax :TRIGger:FLEXray:FRAME:CCRepetition <cycle_count_repetition>
 <cycle_count_repetition> ::= {ALL | <rep #>}
 <rep #> ::= integer from 2-64

The :TRIGger:FLEXray:FRAME:CCRepetition command sets the repetition number of the FlexRay cycle count (in the frame header) to trigger on. The cycle count repetition setting is only valid when the FlexRay trigger mode is set to FRAME.

NOTE

This command is only valid when the FLEXray triggering and serial decode option (Option FLX) has been licensed.

Query Syntax :TRIGger:FLEXray:FRAME:CCRepetition?

The :TRIGger:FLEXray:FRAME:CCRepetition? query returns the current cycle count repetition setting for the FlexRay frame trigger setup.

Return Format <cycle_count_repetition><NL>
 <cycle_count_repetition> ::= {ALL | <rep #>}
 <rep #> ::= integer from 2-64

- See Also**
- ["Introduction to :TRIGger Commands"](#) on page 467
 - [":TRIGger:FLEXray:TRIGger"](#) on page 516

:TRIGger:FLEXray:FRAME:ID

N (see [page 786](#))

Command Syntax :TRIGger:FLEXray:FRAME:ID <frame_id>
 <frame_id> ::= {ALL | <frame #>}
 <frame #> ::= integer from 1-2047

The :TRIGger:FLEXray:FRAME:ID command sets the FlexRay frame ID to trigger on . The frame IF setting is only valid when the FlexRay trigger mode is set to FRAME.

NOTE

This command is only valid when the FLEXray triggering and serial decode option (Option FLX) has been licensed.

Query Syntax :TRIGger:FLEXray:FRAME:ID?

The :TRIGger:FLEXray:FRAME:ID? query returns the current frame ID setting for the FlexRay frame trigger setup.

Return Format <frame_id><NL>
 <frame_id> ::= {ALL | <frame #>}
 <frame #> ::= integer from 1-2047

- See Also**
- "Introduction to :TRIGger Commands" on page 467
 - ":TRIGger:MODE" on page 473
 - ":TRIGger:FLEXray:TRIGger" on page 516

:TRIGger:FLEXray:FRAME:TYPE

N (see [page 786](#))

Command Syntax :TRIGger:FLEXray:FRAME:TYPE <frame_type>

```
<frame_type> ::= {NORMAL | STARTup | NULL | SYNC | NSTArtup | NNULL |
                  NSYNc | ALL}
```

The :TRIGger:FLEXray:FRAME:TYPE command sets the FlexRay frame type to trigger on. The frame type setting is only valid when the FlexRay trigger mode is set to FRAME.

- NORMAL – will trigger on only normal (NSTArtup & NNULL & NSYNc) frames.
- STARTup – will trigger on only startup frames.
- NULL – will trigger on only null frames.
- SYNC – will trigger on only sync frames.
- NSTArtup – will trigger on frames other than startup frames.
- NNULL – will trigger on frames other than null frames.
- NSYNc – will trigger on frames other than sync frames.
- ALL – will trigger on all FlexRay frame types.

NOTE

This command is only valid when the FLEXray triggering and serial decode option (Option FLX) has been licensed.

Query Syntax :TRIGger:FLEXray:FRAME:TYPE?

The :TRIGger:FLEXray:FRAME:TYPE? query returns the current frame type setting for the FlexRay frame trigger setup.

Return Format <frame_type><NL>

```
<frame_type> ::= {NORM | STAR | NULL | SYNC | NSTA | NNUL |
                  NSYN | ALL}
```

- See Also**
- ["Introduction to :TRIGger Commands"](#) on page 467
 - [":TRIGger:MODE"](#) on page 473
 - [":TRIGger:FLEXray:TRIGger"](#) on page 516

:TRIGger:FLEXray:SOURce

N (see [page 786](#))

Command Syntax :TRIGger:FLEXray:SOURce <source>

<source> ::= {CHANnel<n>}

<n> ::= {1 | 2 | 3 | 4}

The :TRIGger:FLEXray:SOURce command specifies the input source for the FlexRay signal.

NOTE

This command is only valid when the FLEXray triggering and serial decode option (Option FLX) has been licensed.

Query Syntax :TRIGger:FLEXray:SOURce?

The :TRIGger:FLEXray:SOURce? query returns the current source for the FlexRay signal.

Return Format <source><NL>

- See Also**
- "[Introduction to :TRIGger Commands](#)" on page 467
 - "[:TRIGger:FLEXray:TRIGger](#)" on page 516
 - "[:TRIGger:FLEXray:EVENT:TYPE](#)" on page 510
 - "[:TRIGger:FLEXray:AUTosetup](#)" on page 506

:TRIGger:FLEXray:TRIGger

N (see [page 786](#))

Command Syntax :TRIGger:FLEXray:TRIGger <condition>
 <condition> ::= {FRAMe | ERRor | EVENT}

The :TRIGger:FLEXray:TRIGger command sets the FLEXray trigger on condition:

- FRAMe – triggers on specified frames (without errors).
- ERRor – triggers on selected active error frames and unknown bus conditions.
- EVENT – triggers on specified FlexRay event/symbol.

NOTE

This command is only valid when the FLEXray triggering and serial decode option (Option FLX) has been licensed.

Query Syntax :TRIGger:FLEXray:TRIGger?

The :TRIGger:FLEXray:TRIGger? query returns the current FLEXray trigger on condition.

Return Format <condition><NL>
 <condition> ::= {FRAM | ERR | EVEN}

- See Also**
- "[Introduction to :TRIGger Commands](#)" on page 467
 - "[:TRIGger:MODE](#)" on page 473
 - "[:TRIGger:FLEXray:ERRor:TYPE](#)" on page 509
 - "[:TRIGger:FLEXray:EVENT:TYPE](#)" on page 510
 - "[:TRIGger:FLEXray:FRAMe:CCBase](#)" on page 511
 - "[:TRIGger:FLEXray:FRAMe:CCRepetition](#)" on page 512
 - "[:TRIGger:FLEXray:FRAMe:ID](#)" on page 513
 - "[:TRIGger:FLEXray:FRAMe:TYPE](#)" on page 514

:TRIGger:GLITch Commands

Table 83 :TRIGger:GLITch Commands Summary

Command	Query	Options and Query Returns
:TRIGger:GLITch:GREAt erthan <greater_than_time>[s uffix] (see page 519)	:TRIGger:GLITch:GREAt erthan? (see page 519)	<greater_than_time> ::= floating-point number in NR3 format [suffix] ::= {s ms us ns ps}
:TRIGger:GLITch:LESSt han <less_than_time>[suff ix] (see page 520)	:TRIGger:GLITch:LESSt han? (see page 520)	<less_than_time> ::= floating-point number in NR3 format [suffix] ::= {s ms us ns ps}
:TRIGger:GLITch:LEVel <level> [<source>] (see page 521)	:TRIGger:GLITch:LEVel ? (see page 521)	For internal triggers, <level> ::= .75 x full-scale voltage from center screen in NR3 format. For external triggers (DSO models), <level> ::= ±(external range setting) in NR3 format. For digital channels (MSO models), <level> ::= ±8 V. <source> ::= {CHANnel<n> EXTernal} for DSO models <source> ::= {CHANnel<n> DIGital0,...,DIGital15} for MSO models <n> ::= 1-2 or 1-4 in NR1 format
:TRIGger:GLITch:POLAr ity <polarity> (see page 522)	:TRIGger:GLITch:POLAr ity? (see page 522)	<polarity> ::= {POSitive NEGative}
:TRIGger:GLITch:QUALi fier <qualifier> (see page 523)	:TRIGger:GLITch:QUALi fier? (see page 523)	<qualifier> ::= {GREATERthan LESSthan RANGE}

5 Commands by Subsystem

Table 83 :TRIGger:GLITCh Commands Summary (continued)

Command	Query	Options and Query Returns
:TRIGger:GLITCh:RANGe <less_than_time>[suffix], <greater_than_time>[suffix] (see page 524)	:TRIGger:GLITCh:RANGe? (see page 524)	<less_than_time> ::= 15 ns to 10 seconds in NR3 format <greater_than_time> ::= 10 ns to 9.99 seconds in NR3 format [suffix] ::= {s ms us ns ps}
:TRIGger:GLITCh:SOURCe <source> (see page 525)	:TRIGger:GLITCh:SOURCe? (see page 525)	<source> ::= {CHANnel<n> EXTernal} for DSO models <source> ::= {CHANnel<n> DIGital0,...,DIGital15 } for MSO models <n> ::= 1-2 or 1-4 in NR1 format

:TRIGger:GLITch:GREaterthan

N (see [page 786](#))

Command Syntax :TRIGger:GLITch:GREaterthan <greater_than_time>[<suffix>]
 <greater_than_time> ::= floating-point number in NR3 format
 <suffix> ::= {s | ms | us | ns | ps}

The :TRIGger:GLITch:GREaterthan command sets the minimum pulse width duration for the selected :TRIGger:GLITch:SOURce.

Query Syntax :TRIGger:GLITch:GREaterthan?

The :TRIGger:GLITch:GREaterthan? query returns the minimum pulse width duration time for :TRIGger:GLITch:SOURce.

Return Format <greater_than_time><NL>
 <greater_than_time> ::= floating-point number in NR3 format.

- See Also**
- ["Introduction to :TRIGger Commands"](#) on page 467
 - [":TRIGger:GLITch:SOURce"](#) on page 525
 - [":TRIGger:GLITch:QUALifier"](#) on page 523
 - [":TRIGger:MODE"](#) on page 473

:TRIGger:GLITch:LESSthan

N (see [page 786](#))

Command Syntax :TRIGger:GLITch:LESSthan <less_than_time>[<suffix>]
<less_than_time> ::= floating-point number in NR3 format
<suffix> ::= {s | ms | us | ns | ps}

The :TRIGger:GLITch:LESSthan command sets the maximum pulse width duration for the selected :TRIGger:GLITch:SOURce.

Query Syntax :TRIGger:GLITch:LESSthan?

The :TRIGger:GLITch:LESSthan? query returns the pulse width duration time for :TRIGger:GLITch:SOURce.

Return Format <less_than_time><NL>
<less_than_time> ::= floating-point number in NR3 format.

- See Also**
- "[Introduction to :TRIGger Commands](#)" on page 467
 - "[:TRIGger:GLITch:SOURce](#)" on page 525
 - "[:TRIGger:GLITch:QUALifier](#)" on page 523
 - "[:TRIGger:MODE](#)" on page 473

:TRIGger:GLITch:LEVel

N (see [page 786](#))

Command Syntax :TRIGger:GLITch:LEVel <level_argument>
 <level_argument> ::= <level>[, <source>]
 <level> ::= .75 x full-scale voltage from center screen in NR3 format
 for internal triggers
 <level> ::= ±(external range setting) in NR3 format
 for external triggers (DSO models)
 <level> ::= ±8 V for digital channels (MSO models)
 <source> ::= {CHANnel<n> | EXTernal} for DSO models
 <source> ::= {CHANnel<n> | DIGital0,..,DIGital15} for MSO models
 <n> ::= {1 | 2 | 3 | 4} for the four channel oscilloscope models
 <n> ::= {1 | 2} for the two channel oscilloscope models

The :TRIGger:GLITch:LEVel command sets the trigger level voltage for the active pulse width trigger.

Query Syntax :TRIGger:GLITch:LEVel?

The :TRIGger:GLITch:LEVel? query returns the trigger level of the current pulse width trigger mode. If all channels are off, the query returns "NONE."

Return Format <level_argument><NL>

- See Also**
- ["Introduction to :TRIGger Commands"](#) on page 467
 - [":TRIGger:MODE"](#) on page 473
 - [":TRIGger:GLITch:SOURce"](#) on page 525
 - [":EXTernal:RANGe"](#) on page 262

:TRIGger:GLITch:POLarity

N (see [page 786](#))

Command Syntax :TRIGger:GLITch:POLarity <polarity>
<polarity> ::= {POSitive | NEGative}

The :TRIGger:GLITch:POLarity command sets the polarity for the glitch pulse width trigger.

Query Syntax :TRIGger:GLITch:POLarity?

The :TRIGger:GLITch:POLarity? query returns the glitch pulse width trigger polarity.

Return Format <polarity><NL>
<polarity> ::= {POS | NEG}

- See Also**
- ["Introduction to :TRIGger Commands"](#) on page 467
 - [":TRIGger:MODE"](#) on page 473
 - [":TRIGger:GLITch:SOURce"](#) on page 525

:TRIGger:GLITCh:QUALifier

N (see [page 786](#))

Command Syntax :TRIGger:GLITCh:QUALifier <operator>

<operator> ::= {GREaterthan | LESSthan | RANGe}

This command sets the mode of operation of the glitch pulse width trigger. The oscilloscope can trigger on a pulse width that is greater than a time value, less than a time value, or within a range of time values.

Query Syntax :TRIGger:GLITCh:QUALifier?

The :TRIGger:GLITCh:QUALifier? query returns the glitch pulse width qualifier.

Return Format <operator><NL>

<operator> ::= {GRE | LESS | RANG}

- See Also**
- "[Introduction to :TRIGger Commands](#)" on page 467
 - "[:TRIGger:GLITCh:SOURce](#)" on page 525
 - "[:TRIGger:MODE](#)" on page 473

:TRIGger:GLITch:RANGe

N (see [page 786](#))

Command Syntax :TRIGger:GLITch:RANGe <less_than_time>[suffix],
<greater_than_time>[suffix]

<less_than_time> ::= (15 ns - 10 seconds) in NR3 format
<greater_than_time> ::= (10 ns - 9.99 seconds) in NR3 format
[suffix] ::= {s | ms | us | ns | ps}

The :TRIGger:GLITch:RANGe command sets the pulse width duration for the selected :TRIGger:GLITch:SOURce. You can enter the parameters in any order – the smaller value becomes the <greater_than_time> and the larger value becomes the <less_than_time>.

Query Syntax :TRIGger:GLITch:RANGe?

The :TRIGger:GLITch:RANGe? query returns the pulse width duration time for :TRIGger:GLITch:SOURce.

Return Format <less_than_time>,<greater_than_time><NL>

- See Also**
- ["Introduction to :TRIGger Commands"](#) on page 467
 - [":TRIGger:GLITch:SOURce"](#) on page 525
 - [":TRIGger:GLITch:QUALifier"](#) on page 523
 - [":TRIGger:MODE"](#) on page 473

:TRIGger:GLITch:SOURce

N (see [page 786](#))

Command Syntax :TRIGger:GLITch:SOURce <source>

<source> ::= {CHANnel<n> | EXTernal} for the DSO models

<source> ::= {DIGital0,...,DIGital15 | CHANnel<n>} for the MSO models

<n> ::= {1 | 2 | 3 | 4} for the four channel oscilloscope models

<n> ::= {1 | 2} for the two channel oscilloscope models

The :TRIGger:GLITch:SOURce command selects the channel that produces the pulse width trigger.

Query Syntax :TRIGger:GLITch:SOURce?

The :TRIGger:GLITch:SOURce? query returns the current pulse width source. If all channels are off, the query returns "NONE."

Return Format <source><NL>

- See Also**
- ["Introduction to :TRIGger Commands"](#) on page 467
 - [":TRIGger:MODE"](#) on page 473
 - [":TRIGger:GLITch:LEVel"](#) on page 521
 - [":TRIGger:GLITch:POLarity"](#) on page 522
 - [":TRIGger:GLITch:QUALifier"](#) on page 523
 - [":TRIGger:GLITch:RANGe"](#) on page 524

Example Code • ["Example Code"](#) on page 504

:TRIGger:I2S Commands**Table 84** :TRIGger:I2S Commands Summary

Command	Query	Options and Query Returns
:TRIGger:I2S:ALIGnment <setting> (see page 528)	:TRIGger:I2S:ALIGnment? (see page 528)	<setting> ::= {I2S LJ RJ}
:TRIGger:I2S:AUDio <audio_ch> (see page 529)	:TRIGger:I2S:AUDio? (see page 529)	<audio_ch> ::= {RIGHT LEFT EITHer}
:TRIGger:I2S:CLOCK:SLOPe <slope> (see page 530)	:TRIGger:I2S:CLOCK:SLOPe? (see page 530)	<slope> ::= {NEGative POSitive}
:TRIGger:I2S:PATtern:DATA <string> (see page 531)	:TRIGger:I2S:PATtern:DATA? (see page 532)	<string> ::= "n" where n ::= 32-bit integer in signed decimal when <base> = DECimal <string> ::= "nn...n" where n ::= {0 1 X \$} when <base> = BINary <string> ::= "0xnn...n" where n ::= {0,...,9 A,...,F X \$} when <base> = HEX
:TRIGger:I2S:PATtern:FORMat <base> (see page 533)	:TRIGger:I2S:PATtern:FORMat? (see page 533)	<base> ::= {BINary HEX DECimal}
:TRIGger:I2S:RANGe <upper>,<lower> (see page 534)	:TRIGger:I2S:RANGe? (see page 534)	<upper> ::= 32-bit integer in signed decimal, <nondecimal>, or <string> <lower> ::= 32-bit integer in signed decimal, <nondecimal>, or <string> <nondecimal> ::= #Hnn...n where n ::= {0,...,9 A,...,F} for hexadecimal <nondecimal> ::= #Bnn...n where n ::= {0 1} for binary <string> ::= "0xnn...n" where n ::= {0,...,9 A,...,F} for hexadecimal
:TRIGger:I2S:RWIDth <receiver> (see page 536)	:TRIGger:I2S:RWIDth? (see page 536)	<receiver> ::= 4-32 in NR1 format

Table 84 :TRIGger:I2S Commands Summary (continued)

Command	Query	Options and Query Returns
:TRIGger:I2S:SOURce:C LOCK <source> (see page 537)	:TRIGger:I2S:SOURce:C LOCK? (see page 537)	<source> ::= {CHANnel<n> EXTernal} for DSO models <source> ::= {CHANnel<n> DIGital0,...,DIGital15 } for MSO models <n> ::= 1-2 or 1-4 in NR1 format
:TRIGger:I2S:SOURce:D ATA <source> (see page 538)	:TRIGger:I2S:SOURce:D ATA? (see page 538)	<source> ::= {CHANnel<n> EXTernal} for DSO models <source> ::= {CHANnel<n> DIGital0,...,DIGital15 } for MSO models <n> ::= 1-2 or 1-4 in NR1 format
:TRIGger:I2S:SOURce:W SElect <source> (see page 539)	:TRIGger:I2S:SOURce:W SElect? (see page 539)	<source> ::= {CHANnel<n> EXTernal} for DSO models <source> ::= {CHANnel<n> DIGital0,...,DIGital15 } for MSO models <n> ::= 1-2 or 1-4 in NR1 format
:TRIGger:I2S:TRIGger <operator> (see page 540)	:TRIGger:I2S:TRIGger? (see page 540)	<operator> ::= {EQUal NOTequal LESSthan GREATERthan INRange OUTRange INCReasing DECReasing}
:TRIGger:I2S:TWIDTH <word_size> (see page 542)	:TRIGger:I2S:TWIDTH? (see page 542)	<word_size> ::= 4-32 in NR1 format
:TRIGger:I2S:WSLow <low_def> (see page 543)	:TRIGger:I2S:WSLow? (see page 543)	<low_def> ::= {LEFT RIGHT}

:TRIGger:I2S:ALIGNment

N (see [page 786](#))

Command Syntax :TRIGger:I2S:ALIGNment <setting>
<setting> ::= {I2S | LJ | RJ}

The :TRIGger:I2S:ALIGNment command selects the data alignment of the I2S bus for the serial decoder and/or trigger when in I2S mode:

- I2S – standard.
- LJ – left justified.
- RJ – right justified.

Note that the word select (WS) polarity is specified separately with the :TRIGger:I2S:WSHigh command.

Query Syntax :TRIGger:I2S:ALIGNment?

The :TRIGger:I2S:ALIGNment? query returns the currently selected I2S data alignment.

Return Format <setting><NL>
<setting> ::= {I2S | LJ | RJ}

- See Also**
- ["Introduction to :TRIGger Commands"](#) on page 467
 - [":TRIGger:I2S:CLOCK:SLOPe"](#) on page 530
 - [":TRIGger:I2S:RWIDth"](#) on page 536
 - [":TRIGger:I2S:TWIDth"](#) on page 542
 - [":TRIGger:I2S:WSLow"](#) on page 543

:TRIGger:I2S:AUDio

N (see [page 786](#))

Command Syntax :TRIGger:I2S:AUDio <audio_ch>
 <audio_ch> ::= {RIGHT | LEFT | EITHER}

The :TRIGger:I2S:AUDio command specifies the audio channel to trigger on:

- RIGHT – right channel.
- LEFT – left channel.
- EITHER – right channel.

Query Syntax :TRIGger:I2S:AUDio?

The :TRIGger:I2S:AUDio? query returns the current audio channel for the I2S trigger.

Return Format <audio_ch><NL>
 <audio_ch> ::= {RIGH | LEFT | EITH}

- See Also**
- ["Introduction to :TRIGger Commands"](#) on page 467
 - [":TRIGger:I2S:TRIGger"](#) on page 540

:TRIGger:I2S:CLOCK:SLOPe

N (see [page 786](#))

Command Syntax :TRIGger:I2S:CLOCK:SLOPe <slope>
<slope> ::= {NEGative | POSitive}

The :TRIGger:I2S:CLOCK:SLOPe command specifies which edge of the I2S serial clock signal clocks in data.

- NEGative – Falling edge.
- POSitive – Rising edge.

Query Syntax :TRIGger:I2S:CLOCK:SLOPe?

The :TRIGger:I2S:CLOCK:SLOPe? query returns the current I2S clock slope setting.

Return Format <slope><NL>
<slope> ::= {NEG | POS}

- See Also**
- "[Introduction to :TRIGger Commands](#)" on page 467
 - "[:TRIGger:I2S:ALIGNment](#)" on page 528
 - "[:TRIGger:I2S:RWIDth](#)" on page 536
 - "[:TRIGger:I2S:TWIDth](#)" on page 542
 - "[:TRIGger:I2S:WSLow](#)" on page 543

:TRIGger:I2S:PATtern:DATA

N (see [page 786](#))

Command Syntax :TRIGger:I2S:PATtern:DATA <string>

<string> ::= "n" where n ::= 32-bit integer in signed decimal when
<base> = DECimal

<string> ::= "nn...n" where n ::= {0 | 1 | X | \$} when
<base> = BINary

<string> ::= "0xnn...n" where n ::= {0,...,9 | A,...,F | X | \$} when
<base> = HEX

NOTE

<base> is specified with the :TRIGger:I2S:PATtern:FORMat command. The default <base> is DECimal.

The :TRIGger:I2S:PATtern:DATA command specifies the I2S trigger data pattern searched for in each I2S message.

Set a <string> bit to "0" or "1" to set the corresponding bit in the data pattern to low or high, respectively.

Set a <string> bit to "X" to ignore (mask off) that bit in the data pattern.

Use the "\$" character to indicate that the value of the corresponding bit will not be changed (the existing bit value is used).

When <base> = DECimal, the "X" and "\$" characters cannot be entered. When queried, the "\$" character is returned when any bits in the pattern have the value of "X" and <base> = DECimal. When any bits in a given nibble have the value of "X" and <base> = HEX, the "\$" character is returned for the corresponding nibble.

NOTE

The :TRIGger:I2S:PATtern:DATA command specifies the I2S trigger data pattern used by the EQUal, NOTequal, GREaterthan, and LESSthan trigger conditions. If the GREaterthan or LESSthan trigger condition is selected, the bits specified to be masked off ("X") will be interpreted as 0's.

NOTE

The length of the trigger data value is determined by the :TRIGger:I2S:RWIDth and :TRIGger:I2S:TWIDth commands. When the receiver word size is less than the transmitter word size, the data length is equal to the receiver word size. When the receiver word size is greater than the transmitter word size, the data length is equal to the transmitter word size.

NOTE

If more bits are sent for <string> than the specified trigger data length, the most significant bits will be truncated. If the word size is changed after the <string> is programmed, the added or deleted bits will be added to or deleted from the least significant bits.

Query Syntax :TRIGger:I2S:PATtern:DATA?

The :TRIGger:I2S:PATtern:DATA? query returns the currently specified I2S trigger data pattern.

Return Format <string><NL>

- See Also**
- "Introduction to :TRIGger Commands" on page 467
 - ":TRIGger:I2S:PATtern:FORMat" on page 533
 - ":TRIGger:I2S:TRIGger" on page 540
 - ":TRIGger:I2S:RWIDth" on page 536
 - ":TRIGger:I2S:TWIDth" on page 542
 - ":TRIGger:I2S:AUDio" on page 529

:TRIGger:I2S:PATtern:FORMat

N (see [page 786](#))

Command Syntax :TRIGger:I2S:PATtern:FORMat <base>
 <base> ::= {BINary | HEX | DECimal}

The :TRIGger:I2S:PATtern:FORMat command sets the entry (and query) number base used by the :TRIGger:I2S:PATtern:DATA command. The default <base> is DECimal.

Query Syntax :TRIGger:I2S:PATtern:FORMat?

The :TRIGger:I2S:PATtern:FORMat? query returns the currently set number base for I2S pattern data.

Return Format <base><NL>
 <base> ::= {BIN | HEX | DEC}

- See Also**
- "[Introduction to :TRIGger Commands](#)" on page 467
 - "[:TRIGger:I2S:AUDio](#)" on page 529
 - "[:TRIGger:I2S:TRIGger](#)" on page 540

:TRIGger:I2S:RANGe

N (see [page 786](#))

Command Syntax :TRIGger:I2S:RANGe <upper>,<lower>

<upper> ::= 32-bit integer in signed decimal, <nondecimal>, or <string>

<lower> ::= 32-bit integer in signed decimal, <nondecimal> or <string>

<nondecimal> ::= #Hnn...n where n ::= {0,...,9 | A,...,F} for hexadecimal

<nondecimal> ::= #Bnn...n where n ::= {0 | 1} for binary

<string> ::= "0xnn...n" where n ::= {0,...,9 | A,...,F} for hexadecimal

The :TRIGger:I2S:RANGe command sets the upper and lower range boundaries used by the INRange, OUTRange, INCRaising, and DECRaising trigger conditions. You can enter the parameters in any order – the smaller value becomes the <lower> and the larger value becomes the <upper>.

Note that for INCRaising and DECRaising, the <upper> and <lower> values correspond to the "Armed" and "Trigger" softkeys.

NOTE

The length of the <upper> and <lower> values is determined by the :TRIGger:I2S:RWIDth and :TRIGger:I2S:TWIDth commands. When the receiver word size is less than the transmitter word size, the length is equal to the receiver word size. When the receiver word size is greater than the transmitter word size, the length is equal to the transmitter word size.

Query Syntax :TRIGger:I2S:RANGe?

The :TRIGger:I2S:RANGe? query returns the currently set upper and lower range boundaries.

Return Format <upper>,<lower><NL>

<upper> ::= 32-bit integer in signed decimal, <nondecimal>, or <string>

<lower> ::= 32-bit integer in signed decimal, <nondecimal> or <string>

<nondecimal> ::= #Hnn...n where n ::= {0,...,9 | A,...,F} for hexadecimal

<nondecimal> ::= #Bnn...n where n ::= {0 | 1} for binary

<string> ::= "0xnn...n" where n ::= {0,...,9 | A,...,F} for hexadecimal

See Also • ["Introduction to :TRIGger Commands"](#) on page 467

- `":TRIGger:I2S:TRIGger"` on page 540
- `":TRIGger:I2S:RWIDth"` on page 536
- `":TRIGger:I2S:TWIDth"` on page 542
- `":TRIGger:I2S:WSLow"` on page 543

:TRIGger:I2S:RWIDth

N (see [page 786](#))

Command Syntax :TRIGger:I2S:RWIDth <receiver>

<receiver> ::= 4-32 in NR1 format

The :TRIGger:I2S:RWIDth command sets the width of the receiver (decoded) data word in I2S anywhere from 4 bits to 32 bits.

Query Syntax :TRIGger:I2S:RWIDth?

The :TRIGger:I2S:RWIDth? query returns the currently set I2S receiver data word width.

Return Format <receiver><NL>

<receiver> ::= 4-32 in NR1 format

- See Also**
- "[Introduction to :TRIGger Commands](#)" on page 467
 - "[:TRIGger:I2S:ALIGNment](#)" on page 528
 - "[:TRIGger:I2S:CLOCK:SLOPe](#)" on page 530
 - "[:TRIGger:I2S:TWIDth](#)" on page 542
 - "[:TRIGger:I2S:WSLow](#)" on page 543

:TRIGger:I2S:SOURce:CLOCK

N (see [page 786](#))

Command Syntax :TRIGger:I2S:SOURce:CLOCK <source>

<source> ::= {CHANnel<n> | EXTernal} for the DSO models

<source> ::= {CHANnel<n> | DIGital0,..,DIGital15} for the MSO models

<n> ::= {1 | 2 | 3 | 4} for the four channel oscilloscope models

<n> ::= {1 | 2} for the two channel oscilloscope models

The :TRIGger:I2S:SOURce:CLOCK controls which signal is used as the serial clock (SCLK) source by the serial decoder and/or trigger when in I2S mode.

Query Syntax :TRIGger:I2S:SOURce:CLOCK?

The :TRIGger:I2S:SOURce:CLOCK? query returns the current source for the I2S serial clock (SCLK).

Return Format <source><NL>

- See Also**
- ["Introduction to :TRIGger Commands"](#) on page 467
 - [":TRIGger:I2S:SOURce:DATA"](#) on page 538
 - [":TRIGger:I2S:SOURce:WSElect"](#) on page 539

:TRIGger:I2S:SOURce:DATA

N (see [page 786](#))

Command Syntax :TRIGger:I2S:SOURce:DATA <source>

<source> ::= {CHANnel<n> | EXTernal} for the DSO models

<source> ::= {CHANnel<n> | DIGital0,...,DIGital15} for the MSO models

<n> ::= {1 | 2 | 3 | 4} for the four channel oscilloscope models

<n> ::= {1 | 2} for the two channel oscilloscope models

The :TRIGger:I2S:SOURce:DATA command controls which signal is used as the serial data (SDATA) source by the serial decoder and/or trigger when in I2S mode.

Query Syntax :TRIGger:I2S:SOURce:DATA?

The :TRIGger:I2S:SOURce:DATA? query returns the current source for the I2S serial data (SDATA).

Return Format <source><NL>

- See Also**
- ["Introduction to :TRIGger Commands"](#) on page 467
 - [":TRIGger:I2S:SOURce:CLOCK"](#) on page 537
 - [":TRIGger:I2S:SOURce:WSElect"](#) on page 539

:TRIGger:I2S:SOURce:WSElect

N (see [page 786](#))

Command Syntax :TRIGger:I2S:SOURce:WSElect <source>

<source> ::= {CHANnel<n> | EXTernal} for the DSO models

<source> ::= {CHANnel<n> | DIGital0,...,DIGital15} for the MSO models

<n> ::= {1 | 2 | 3 | 4} for the four channel oscilloscope models

<n> ::= {1 | 2} for the two channel oscilloscope models

The :TRIGger:I2S:SOURce:WSElect command controls which signal is used as the word select (WS) source by the serial decoder and/or trigger when in I2S mode.

Query Syntax :TRIGger:I2S:SOURce:WSElect?

The :TRIGger:I2S:SOURce:WSElect? query returns the current source for I2S word select (WS).

Return Format <source><NL>

- See Also**
- ["Introduction to :TRIGger Commands"](#) on page 467
 - [":TRIGger:I2S:SOURce:CLOCK"](#) on page 537
 - [":TRIGger:I2S:SOURce:DATA"](#) on page 538

:TRIGger:I2S:TRIGger

N (see page 786)

Command Syntax :TRIGger:I2S:TRIGger <operator>

<operator> ::= {EQUAL | NOTequal | LESSthan | GREATERthan | INRange
| OUTRange | INCRasing | DECRasing}

The :TRIGger:I2S:TRIGger command sets the I2S trigger operator:

- **EQUAL**— triggers on the specified audio channel's data word when it equals the specified word.
- **NOTequal** — triggers on any word other than the specified word.
- **LESSthan** — triggers when the channel's data word is less than the specified value.
- **GREATERthan** — triggers when the channel's data word is greater than the specified value.
- **INRange** — enter upper and lower values to specify the range in which to trigger.
- **OUTRange** — enter upper and lower values to specify range in which trigger will not occur.
- **INCRasing** — triggers when the data value makes a certain increase over time and the specified value is met or exceeded. Use the :TRIGger:I2S:RANGe command to set "Trigger" and "Armed" values. The "Trigger" value is the value that must be met or exceeded to cause the trigger. The "Armed" value is the value the data must go below in order to re-arm the oscilloscope (ready it to trigger again).

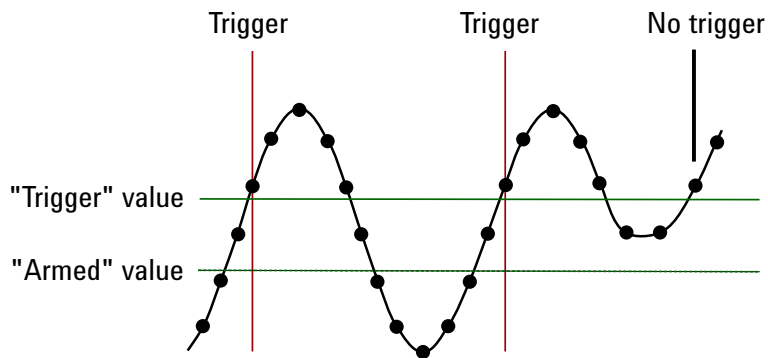

- **DECRasing** — similar to INCRasing except the trigger occurs on a certain decrease over time and the "Trigger" data value is less than the "Armed" data value.

Query Syntax :TRIGger:I2S:TRIGger?

The `:TRIGger:I2S:TRIGger?` query returns the current I2S trigger operator.

Return Format `<operator><NL>`

`<operator> ::= {EQU | NOT | LESS | GRE | INR | OUTR | INCR | DECR}`

- See Also**
- ["Introduction to :TRIGger Commands"](#) on page 467
 - [":TRIGger:I2S:AUDio"](#) on page 529
 - [":TRIGger:I2S:RANGe"](#) on page 534
 - [":TRIGger:I2S:PATtern:FORMat"](#) on page 533

:TRIGger:I2S:TWIDth

N (see [page 786](#))

Command Syntax :TRIGger:I2S:TWIDth <word_size>

<word_size> ::= 4-32 in NR1 format

The :TRIGger:I2S:TWIDth command sets the width of the transmitted data word in I2S anywhere from 4 bits to 32 bits.

Query Syntax :TRIGger:I2S:TWIDth?

The :TRIGger:I2S:TWIDth? query returns the currently set I2S transmitted data word width.

Return Format <word_size><NL>

<word_size> ::= 4-32 in NR1 format

- See Also**
- "[Introduction to :TRIGger Commands](#)" on page 467
 - "[:TRIGger:I2S:ALIGNment](#)" on page 528
 - "[:TRIGger:I2S:CLOCK:SLOPe](#)" on page 530
 - "[:TRIGger:I2S:RWIDth](#)" on page 536
 - "[:TRIGger:I2S:WSLow](#)" on page 543

:TRIGger:I2S:WSLow

N (see [page 786](#))

Command Syntax :TRIGger:I2S:WSLow <low_def>

<low_def> ::= {LEFT | RIGHT}

The :TRIGger:I2S:WSLow command selects the polarity of the word select (WS) signal:

- LEFT— a word select (WS) state of low indicates left channel data is active on the I2S bus, and a WS state of high indicates right channel data is active on the bus.
- RIGHT — a word select (WS) state of low indicates right channel data is active on the I2S bus, and a WS state of high indicates left channel data is active on the bus.

Query Syntax :TRIGger:I2S:WSLow?

The :TRIGger:I2S:WSLow? query returns the currently selected I2S word select (WS) polarity.

Return Format <low_def><NL>

<low_def> ::= {LEFT | RIGHT}

- See Also**
- ["Introduction to :TRIGger Commands"](#) on page 467
 - [":TRIGger:I2S:ALIGNment"](#) on page 528
 - [":TRIGger:I2S:CLOCK:SLOPe"](#) on page 530
 - [":TRIGger:I2S:RWIDth"](#) on page 536
 - [":TRIGger:I2S:TWIDth"](#) on page 542

:TRIGger:IIC Commands

Table 85 :TRIGger:IIC Commands Summary

Command	Query	Options and Query Returns
:TRIGger:IIC:PATtern:ADDRess <value> (see page 545)	:TRIGger:IIC:PATtern:ADDRess? (see page 545)	<value> ::= integer or <string> <string> ::= "0xnn" n ::= {0,...,9 A,...,F}
:TRIGger:IIC:PATtern:DATA <value> (see page 546)	:TRIGger:IIC:PATtern:DATA? (see page 546)	<value> ::= integer or <string> <string> ::= "0xnn" n ::= {0,...,9 A,...,F}
:TRIGger:IIC:PATtern:DATA2 <value> (see page 547)	:TRIGger:IIC:PATtern:DATA2? (see page 547)	<value> ::= integer or <string> <string> ::= "0xnn" n ::= {0,...,9 A,...,F}
:TRIGger:IIC[:SOURce]:CLOCK <source> (see page 548)	:TRIGger:IIC[:SOURce]:CLOCK? (see page 548)	<source> ::= {CHANnel<n> EXTErnal} for DSO models <source> ::= {CHANnel<n> DIGital0,...,DIGital15 } for MSO models <n> ::= 1-2 or 1-4 in NR1 format
:TRIGger:IIC[:SOURce]:DATA <source> (see page 549)	:TRIGger:IIC[:SOURce]:DATA? (see page 549)	<source> ::= {CHANnel<n> EXTErnal} for DSO models <source> ::= {CHANnel<n> DIGital0,...,DIGital15 } for MSO models <n> ::= 1-2 or 1-4 in NR1 format
:TRIGger:IIC:TRIGger:QUALifier <value> (see page 550)	:TRIGger:IIC:TRIGger:QUALifier? (see page 550)	<value> ::= {EQUal NOTequal LESSthan GREATERthan}
:TRIGger:IIC:TRIGger[:TYPE] <type> (see page 551)	:TRIGger:IIC:TRIGger[:TYPE]? (see page 551)	<type> ::= {START STOP READ7 READEprom WRITe7 WRITe10 NACKnowledge ANACKnowledge R7Data2 W7Data2 REStart}

:TRIGger:IIC:PATtern:ADDRESS

N (see [page 786](#))

Command Syntax :TRIGger:IIC:PATtern:ADDRESS <value>

<value> ::= integer or <string>

<string> ::= "0xnn" where n ::= {0,...,9 | A,...,F}

The :TRIGger:IIC:PATtern:ADDRESS command sets the address for IIC data. The address can range from 0x00 to 0x7F (7-bit) or 0x3FF (10-bit) hexadecimal. Use the don't care address (-1 or 0xFFFFFFFF) to ignore the address value.

Query Syntax :TRIGger:IIC:PATtern:ADDRESS?

The :TRIGger:IIC:PATtern:ADDRESS? query returns the current address for IIC data.

Return Format <value><NL>

<value> ::= integer

- See Also**
- ["Introduction to :TRIGger Commands"](#) on page 467
 - [":TRIGger:IIC:PATtern:DATA"](#) on page 546
 - [":TRIGger:IIC:PATtern:DATA2"](#) on page 547
 - [":TRIGger:IIC:TRIGger\[:TYPE\]"](#) on page 551

:TRIGger:IIC:PATtern:DATA

N (see [page 786](#))

Command Syntax :TRIGger:IIC:PATtern:DATA <value>

<value> ::= integer or <string>

<string> ::= "0xnn" where n ::= {0,...,9 | A,...,F}

The :TRIGger:IIC:PATtern:DATA command sets IIC data. The data value can range from 0x00 to 0x0FF (hexadecimal). Use the don't care data pattern (-1 or 0xFFFFFFFF) to ignore the data value.

Query Syntax :TRIGger:IIC:PATtern:DATA?

The :TRIGger:IIC:PATtern:DATA? query returns the current pattern for IIC data.

Return Format <value><NL>

- See Also**
- ["Introduction to :TRIGger Commands"](#) on page 467
 - [":TRIGger:IIC:PATtern:ADDRess"](#) on page 545
 - [":TRIGger:IIC:PATtern:DATA2"](#) on page 547
 - [":TRIGger:IIC:TRIGger\[:TYPE\]"](#) on page 551

:TRIGger:IIC:PATtern:DATA2

N (see [page 786](#))

Command Syntax :TRIGger:IIC:PATtern:DATA2 <value>

<value> ::= integer or <string>

<string> ::= "0xnn" where n ::= {0,...,9 | A,...,F}

The :TRIGger:IIC:PATtern:DATA2 command sets IIC data 2. The data value can range from 0x00 to 0x0FF (hexadecimal). Use the don't care data pattern (-1 or 0xFFFFFFFF) to ignore the data value.

Query Syntax :TRIGger:IIC:PATtern:DATA2?

The :TRIGger:IIC:PATtern:DATA2? query returns the current pattern for IIC data 2.

Return Format <value><NL>

- See Also**
- ["Introduction to :TRIGger Commands"](#) on page 467
 - [":TRIGger:IIC:PATtern:ADDRESS"](#) on page 545
 - [":TRIGger:IIC:PATtern:DATA"](#) on page 546
 - [":TRIGger:IIC:TRIGger\[:TYPE\]"](#) on page 551

:TRIGger:IIC[:SOURce]:CLOCK

N (see [page 786](#))

Command Syntax :TRIGger:IIC:[SOURce:]CLOCK <source>

<source> ::= {CHANnel<n> | EXTernal} for the DSO models

<source> ::= {CHANnel<n> | DIGital0,...,DIGital15} for the MSO models

<n> ::= {1 | 2 | 3 | 4} for the four channel oscilloscope models

<n> ::= {1 | 2} for the two channel oscilloscope models

The :TRIGger:IIC:[SOURce:]CLOCK command sets the source for the IIC serial clock (SCL).

Query Syntax :TRIGger:IIC:[SOURce:]CLOCK?

The :TRIGger:IIC:[SOURce:]CLOCK? query returns the current source for the IIC serial clock.

Return Format <source><NL>

- See Also**
- ["Introduction to :TRIGger Commands"](#) on page 467
 - [":TRIGger:IIC\[:SOURce\]:DATA"](#) on page 549

:TRIGger:IIC[:SOURce]:DATA

N (see [page 786](#))

Command Syntax :TRIGger:IIC:[SOURce:]DATA <source>

<source> ::= {CHANnel<n> | EXTernal} for the DSO models

<source> ::= {CHANnel<n> | DIGital0,..,DIGital15} for the MSO models

<n> ::= {1 | 2 | 3 | 4} for the four channel oscilloscope models

<n> ::= {1 | 2} for the two channel oscilloscope models

The :TRIGger:IIC:[SOURce:]DATA command sets the source for IIC serial data (SDA).

Query Syntax :TRIGger:IIC:[SOURce:]DATA?

The :TRIGger:IIC:[SOURce:]DATA? query returns the current source for IIC serial data.

Return Format <source><NL>

- See Also**
- ["Introduction to :TRIGger Commands"](#) on page 467
 - [":TRIGger:IIC\[:SOURce\]:CLOCK"](#) on page 548

:TRIGger:IIC:TRIGger:QUALifier

N (see [page 786](#))

Command Syntax :TRIGger:IIC:TRIGger:QUALifier <value>
<value> ::= {EQUAL | NOTequal | LESSthan | GREATERthan}

The :TRIGger:IIC:TRIGger:QUALifier command sets the IIC data qualifier when TRIGger:IIC:TRIGger[:TYPE] is set to READEprom.

Query Syntax :TRIGger:IIC:TRIGger:QUALifier?

The :TRIGger:IIC:TRIGger:QUALifier? query returns the current IIC data qualifier value.

Return Format <value><NL>
<value> ::= {EQUAL | NOTequal | LESSthan | GREATERthan}

- See Also**
- "[Introduction to :TRIGger Commands](#)" on page 467
 - "[:TRIGger:MODE](#)" on page 473
 - "[:TRIGger:IIC:TRIGger\[:TYPE\]](#)" on page 551

:TRIGger:IIC:TRIGger[:TYPE]

N (see [page 786](#))

Command Syntax :TRIGger:IIC:TRIGger[:TYPE] <value>

<value> ::= {START | STOP | READ7 | READEprom | WRITe7 | WRITe10
| NACKnowledge | ANACKnowledge | R7Data2 | W7Data2 | REStart}

The :TRIGger:IIC:TRIGger[:TYPE] command sets the IIC trigger type:

- START – Start condition.
- STOP – Stop condition.
- READ7 – 7-bit address frame containing (Start:Address7:Read:Ack:Data). The value READ is also accepted for READ7.
- R7Data2 – 7-bit address frame containing (Start:Address7:Read:Ack:Data:Ack:Data2).
- READEprom – EEPROM data read.
- WRITe7 – 7-bit address frame containing (Start:Address7:Write:Ack:Data). The value WRITE is also accepted for WRITe7.
- W7Data2 – 7-bit address frame containing (Start:Address7:Write:Ack:Data:Ack:Data2).
- WRITe10 – 10-bit address frame containing (Start:Address byte1:Write:Ack:Address byte 2:Data).
- NACKnowledge – Missing acknowledge.
- ANACKnowledge – Address with no acknowledge.
- REStart – Another start condition occurs before a stop condition.

NOTE

The short form of READ7 (READ7), READEprom (READE), WRITe7 (WRIT7), and WRITe10 (WRIT10) do not follow the defined Long Form to Short Form Truncation Rules (see [page 788](#)).

Query Syntax :TRIGger:IIC:TRIGger[:TYPE]?

The :TRIGger:IIC:TRIGger[:TYPE]? query returns the current IIC trigger type value.

Return Format <value><NL>

<value> ::= {STAR | STOP | READ7 | READE | WRIT7 | WRIT10 | NACK | ANAC
| R7D2 | W7D2 | REST}

- See Also**
- "[Introduction to :TRIGger Commands](#)" on page 467
 - "[:TRIGger:MODE](#)" on page 473

5 Commands by Subsystem

- [":TRIGger:IIC:PATtern:ADDRes"](#) on page 545
- [":TRIGger:IIC:PATtern:DATA"](#) on page 546
- [":TRIGger:IIC:PATtern:DATA2"](#) on page 547
- [":TRIGger:IIC:TRIGger:QUALifier"](#) on page 550
- ["Long Form to Short Form Truncation Rules"](#) on page 788

:TRIGger:LIN Commands

Table 86 :TRIGger:LIN Commands Summary

Command	Query	Options and Query Returns
:TRIGger:LIN:ID <value> (see page 555)	:TRIGger:LIN:ID? (see page 555)	<value> ::= 7-bit integer in decimal, <nondecimal>, or <string> from 0-63 or 0x00-0x3f (with Option AMS) <nondecimal> ::= #Hnn where n ::= {0,...,9 A,...,F} for hexadecimal <nondecimal> ::= #Bnn...n where n ::= {0 1} for binary <string> ::= "0xnn" where n ::= {0,...,9 A,...,F} for hexadecimal
:TRIGger:LIN:PATtern: DATA <string> (see page 556)	:TRIGger:LIN:PATtern: DATA? (see page 557)	<string> ::= "n" where n ::= 32-bit integer in signed decimal when <base> = DECimal <string> ::= "nn...n" where n ::= {0 1 X \$} when <base> = BINary <string> ::= "0xnn...n" where n ::= {0,...,9 A,...,F X \$} when <base> = HEX
:TRIGger:LIN:PATtern: DATA:LENGth <length> (see page 558)	:TRIGger:LIN:PATtern: DATA:LENGth? (see page 558)	<length> ::= integer from 1 to 8 in NR1 format
:TRIGger:LIN:PATtern: FORMat <base> (see page 559)	:TRIGger:LIN:PATtern: FORMat? (see page 559)	<base> ::= {BINary HEX DECimal}
:TRIGger:LIN:SAMPlepo int <value> (see page 560)	:TRIGger:LIN:SAMPlepo int? (see page 560)	<value> ::= {60 62.5 68 70 75 80 87.5} in NR3 format
:TRIGger:LIN:SIGNAL:B AUDrate <baudrate> (see page 561)	:TRIGger:LIN:SIGNAL:B AUDrate? (see page 561)	<baudrate> ::= integer from 2400 to 625000 in 100 b/s increments
:TRIGger:LIN:SOURce <source> (see page 562)	:TRIGger:LIN:SOURce? (see page 562)	<source> ::= {CHANnel<n> EXTernal} for DSO models <source> ::= {CHANnel<n> DIGital0,...,DIGital15} for MSO models <n> ::= 1-2 or 1-4 in NR1 format
:TRIGger:LIN:STANdard <std> (see page 563)	:TRIGger:LIN:STANdard ? (see page 563)	<std> ::= {LIN13 LIN20}

5 Commands by Subsystem

Table 86 :TRIGger:LIN Commands Summary (continued)

Command	Query	Options and Query Returns
:TRIGger:LIN:SYNCbreak <value> (see page 564)	:TRIGger:LIN:SYNCbreak? (see page 564)	<value> ::= integer = {11 12 13}
:TRIGger:LIN:TRIGger <condition> (see page 565)	:TRIGger:LIN:TRIGger? (see page 565)	<condition> ::= {SYNCbreak} (without Option AMS) <condition> ::= {SYNCbreak ID DATA} (with Option AMS)

:TRIGger:LIN:ID

N (see [page 786](#))

Command Syntax :TRIGger:LIN:ID <value>

<value> ::= 7-bit integer in decimal, <nondecimal>, or <string>
from 0-63 or 0x00-0x3f

<nondecimal> ::= #Hnn where n ::= {0,...,9 | A,...,F} for hexadecimal

<nondecimal> ::= #Bnn...n where n ::= {0 | 1} for binary

<string> ::= "0xnn" where n ::= {0,...,9 | A,...,F} for hexadecimal

The :TRIGger:LIN:ID command defines the LIN identifier searched for in each CAN message when the LIN trigger mode is set to frame ID.

NOTE

This command is only valid when the automotive CAN and LIN serial decode option (Option AMS) has been licensed.

Setting the ID to a value of "-1" results in "0xXX" which is equivalent to all IDs.

Query Syntax :TRIGger:LIN:ID?

The :TRIGger:LIN:ID? query returns the current LIN identifier setting.

Return Format <value><NL>

<value> ::= integer in decimal

Errors • ["-241, Hardware missing"](#) on page 745

See Also • ["Introduction to :TRIGger Commands"](#) on page 467
• [":TRIGger:MODE"](#) on page 473
• [":TRIGger:LIN:TRIGger"](#) on page 565
• [":TRIGger:LIN:SIGNAL:DEFinition"](#) on page 740
• [":TRIGger:LIN:SOURce"](#) on page 562

:TRIGger:LIN:PATtern:DATA

N (see [page 786](#))

Command Syntax :TRIGger:LIN:PATtern:DATA <string>

<string> ::= "n" where n ::= 32-bit integer in signed decimal when
<base> = DECimal

<string> ::= "nn...n" where n ::= {0 | 1 | X | \$} when
<base> = BINary

<string> ::= "0xnn...n" where n ::= {0,...,9 | A,...,F | X | \$} when
<base> = HEX

NOTE

<base> is specified with the :TRIGger:LIN:PATtern:FORMat command. The default <base> is DECimal.

The :TRIGger:LIN:PATtern:DATA command specifies the LIN trigger data pattern searched for in each LIN data field.

Set a <string> bit to "0" or "1" to set the corresponding bit in the data pattern to low or high, respectively.

Set a <string> bit to "X" to ignore (mask off) that bit in the data pattern.

Use the "\$" character to indicate that the value of the corresponding bit will not be changed (the existing bit value is used).

When <base> = DECimal, the "X" and "\$" characters cannot be entered. When queried, the "\$" character is returned when any bits in the pattern have the value of "X" and <base> = DECimal. When any bits in a given nibble have the value of "X" and <base> = HEX, the "\$" character is returned for the corresponding nibble.

NOTE

The :TRIGger:LIN:PATtern:DATA command specifies the LIN trigger data pattern used by the DATA trigger condition. This command is only valid when the automotive CAN and LIN serial decode option (Option AMS) has been licensed.

NOTE

The length of the trigger data value is determined by the :TRIGger:LIN:PATtern:DATA:LENGth command.

NOTE

If more bits are sent for <string> than the specified trigger pattern data length, the most significant bits will be truncated. If the data length size is changed after the <string> is programmed, the added or deleted bits will be added to or deleted from the least significant bits.

Query Syntax `:TRIGger:LIN:PATtern:DATA?`

The `:TRIGger:LIN:PATtern:DATA?` query returns the currently specified LIN trigger data pattern.

Return Format `<string><NL>`

- See Also**
- ["Introduction to :TRIGger Commands"](#) on page 467
 - [":TRIGger:LIN:PATtern:FORMat"](#) on page 559
 - [":TRIGger:LIN:TRIGger"](#) on page 565
 - [":TRIGger:LIN:PATtern:DATA:LENGth"](#) on page 558

:TRIGger:LIN:PATtern:DATA:LENGth

N (see [page 786](#))

Command Syntax :TRIGger:LIN:PATtern:DATA:LENGth <length>
<length> ::= integer from 1 to 8 in NR1 format

The :TRIGger:LIN:PATtern:DATA:LENGth command sets the number of 8-bit bytes in the LIN data string. The number of bytes in the string can be anywhere from 0 bytes to 8 bytes (64 bits). The value for these bytes is set by the :TRIGger:LIN:PATtern:DATA command.

NOTE

This command is only valid when the automotive CAN and LIN serial decode option (Option AMS) has been licensed.

Query Syntax :TRIGger:LIN:PATtern:DATA:LENGth?

The :TRIGger:LIN:PATtern:DATA:LENGth? query returns the current LIN data pattern length setting.

Return Format <count><NL>
<count> ::= integer from 1 to 8 in NR1 format

Errors • "-241, Hardware missing" on [page 745](#)

See Also • "Introduction to :TRIGger Commands" on [page 467](#)
• ":TRIGger:LIN:PATtern:DATA" on [page 556](#)
• ":TRIGger:LIN:SOURce" on [page 562](#)

:TRIGger:LIN:PATtern:FORMat

N (see [page 786](#))

Command Syntax :TRIGger:LIN:PATtern:FORMat <base>
 <base> ::= {BINary | HEX | DECimal}

The :TRIGger:LIN:PATtern:FORMat command sets the entry (and query) number base used by the :TRIGger:LIN:PATtern:DATA command. The default <base> is DECimal.

NOTE

This command is only valid when the automotive CAN and LIN serial decode option (Option AMS) has been licensed.

Query Syntax :TRIGger:LIN:PATtern:FORMat?

The :TRIGger:LIN:PATtern:FORMat? query returns the currently set number base for LIN pattern data.

Return Format <base><NL>
 <base> ::= {BIN | HEX | DEC}

- See Also**
- ["Introduction to :TRIGger Commands"](#) on page 467
 - [":TRIGger:LIN:PATtern:DATA"](#) on page 556
 - [":TRIGger:LIN:PATtern:DATA:LENGth"](#) on page 558

:TRIGger:LIN:SAMPlEpoint

N (see [page 786](#))

Command Syntax :TRIGger:LIN:SAMPlEpoint <value>

<value><NL>

<value> ::= {60 | 62.5 | 68 | 70 | 75 | 80 | 87.5} in NR3 format

The :TRIGger:LIN:SAMPlEpoint command sets the point during the bit time where the bit level is sampled to determine whether the bit is dominant or recessive. The sample point represents the percentage of time between the beginning of the bit time to the end of the bit time.

NOTE

The sample point values are not limited by the baud rate.

Query Syntax :TRIGger:LIN:SAMPlEpoint?

The :TRIGger:LIN:SAMPlEpoint? query returns the current LIN sample point setting.

Return Format <value><NL>

<value> ::= {60 | 62.5 | 68 | 70 | 75 | 80 | 87.5} in NR3 format

- See Also**
- "[Introduction to :TRIGger Commands](#)" on page 467
 - "[:TRIGger:MODE](#)" on page 473
 - "[:TRIGger:LIN:TRIGger](#)" on page 565

:TRIGger:LIN:SIGNal:BAUDrate

N (see [page 786](#))

Command Syntax :TRIGger:LIN:SIGNal:BAUDrate <baudrate>

<baudrate> ::= integer from 2400 to 625000 in 100 b/s increments

The :TRIGger:LIN:SIGNal:BAUDrate command sets the standard baud rate of the LIN signal from 2400 b/s to 625 kb/s in 100 b/s increments. If you enter a baud rate that is not divisible by 100 b/s, the baud rate is set to the nearest baud rate divisible by 100 b/s.

Query Syntax :TRIGger:LIN:SIGNal:BAUDrate?

The :TRIGger:LIN:SIGNal:BAUDrate? query returns the current LIN baud rate setting.

Return Format <baudrate><NL>

<baudrate> ::= integer from 2400 to 625000 in 100 b/s increments

- See Also**
- ["Introduction to :TRIGger Commands"](#) on page 467
 - [":TRIGger:MODE"](#) on page 473
 - [":TRIGger:LIN:TRIGger"](#) on page 565
 - [":TRIGger:LIN:SIGNal:DEFinition"](#) on page 740
 - [":TRIGger:LIN:SOURce"](#) on page 562

:TRIGger:LIN:SOURce

N (see [page 786](#))

Command Syntax :TRIGger:LIN:SOURce <source>

<source> ::= {CHANnel<n> | EXTernal} for the DSO models

<source> ::= {CHANnel<n> | DIGital0,...,DIGital15} for the MSO models

<n> ::= {1 | 2 | 3 | 4} for the four channel oscilloscope models

<n> ::= {1 | 2} for the two channel oscilloscope models

The :TRIGger:LIN:SOURce command sets the source for the LIN signal.

Query Syntax :TRIGger:LIN:SOURce?

The :TRIGger:LIN:SOURce? query returns the current source for the LIN signal.

Return Format <source><NL>

- See Also**
- ["Introduction to :TRIGger Commands"](#) on page 467
 - [":TRIGger:MODE"](#) on page 473
 - [":TRIGger:LIN:TRIGger"](#) on page 565
 - [":TRIGger:LIN:SIGNAL:DEFinition"](#) on page 740

:TRIGger:LIN:STANdard

N (see [page 786](#))

Command Syntax :TRIGger:LIN:STANdard <std>
 <std> ::= {LIN13 | LIN20}

The :TRIGger:LIN:STANdard command sets the LIN standard in effect for triggering and decoding to be LIN1.3 or LIN2.0.

Query Syntax :TRIGger:LIN:STANdard?

The :TRIGger:LIN:STANdard? query returns the current LIN standard setting.

Return Format <std><NL>
 <std> ::= {LIN13 | LIN20}

- See Also**
- ["Introduction to :TRIGger Commands"](#) on page 467
 - [":TRIGger:MODE"](#) on page 473
 - [":TRIGger:LIN:SIGNAL:DEFinition"](#) on page 740
 - [":TRIGger:LIN:SOURce"](#) on page 562

:TRIGger:LIN:SYNCbreak

N (see [page 786](#))

Command Syntax :TRIGger:LIN:SYNCbreak <value>
<value> ::= integer = {11 | 12 | 13}

The :TRIGger:LIN:SYNCbreak command sets the length of the LIN sync break to be greater than or equal to 11, 12, or 13 clock lengths. The sync break is the idle period in the bus activity at the beginning of each packet that distinguishes one information packet from the previous one.

Query Syntax :TRIGger:LIN:SYNCbreak?

The :TRIGger:LIN:STANdard? query returns the current LIN sync break setting.

Return Format <value><NL>
<value> ::= {11 | 12 | 13}

- See Also**
- "[Introduction to :TRIGger Commands](#)" on page 467
 - "[:TRIGger:MODE](#)" on page 473
 - "[:TRIGger:LIN:SIGNal:DEFinition](#)" on page 740
 - "[:TRIGger:LIN:SOURce](#)" on page 562

:TRIGger:LIN:TRIGger

N (see [page 786](#))

Command Syntax :TRIGger:LIN:TRIGger <condition>
 <condition> ::= {SYNCbreak | ID | DATA}

The :TRIGger:LIN:TRIGger command sets the LIN trigger condition to be:

- SYNCbreak – Sync Break.
- ID – Frame ID.

Use the :TRIGger:LIN:ID command to specify the frame ID.

- DATA – Frame ID and Data.

Use the :TRIGger:LIN:ID command to specify the frame ID.

Use the :TRIGger:LIN:PATtern:DATA:LENGth and :TRIGger:LIN:PATtern:DATA commands to specify the data string length and value.

NOTE

The ID and DATA options are available when the automotive CAN and LIN serial decode option (Option AMS) has been licensed.

Query Syntax :TRIGger:LIN:TRIGger?

The :TRIGger:LIN:TRIGger? query returns the current LIN trigger value.

Return Format <condition><NL>
 <condition> ::= {SYNC | ID | DATA}

Errors • "-241, Hardware missing" on [page 745](#)

See Also • ["Introduction to :TRIGger Commands"](#) on [page 467](#)
 • [":TRIGger:MODE"](#) on [page 473](#)
 • [":TRIGger:LIN:ID"](#) on [page 555](#)
 • [":TRIGger:LIN:PATtern:DATA:LENGth"](#) on [page 558](#)
 • [":TRIGger:LIN:PATtern:DATA"](#) on [page 556](#)
 • [":TRIGger:LIN:SIGNAL:DEFinition"](#) on [page 740](#)
 • [":TRIGger:LIN:SOURce"](#) on [page 562](#)

:TRIGger:M1553 Commands

Table 87 :TRIGger:M1553 Commands Summary

Command	Query	Options and Query Returns
:TRIGger:M1553:AUTOsetup (see page 567)	n/a	n/a
:TRIGger:M1553:PATTERN:DATA <string> (see page 568)	:TRIGger:M1553:PATTERN:DATA? (see page 568)	<string> ::= "nn...n" where n ::= {0 1 X}
:TRIGger:M1553:RTA <value> (see page 569)	:TRIGger:M1553:RTA? (see page 569)	<value> ::= 5-bit integer in decimal, <nondecimal>, or <string> from 0-31 <nondecimal> ::= #Hnn where n ::= {0,...,9 A,...,F} <string> ::= "0xnn" where n ::= {0,...,9 A,...,F}
:TRIGger:M1553:SOURCE:LOWER <source> (see page 570)	:TRIGger:M1553:SOURCE:LOWER? (see page 570)	<source> ::= {CHANNEL<n>} <n> ::= {2 4}
:TRIGger:M1553:SOURCE:UPPER <source> (see page 571)	:TRIGger:M1553:SOURCE:UPPER? (see page 571)	<source> ::= {CHANNEL<n>} <n> ::= {1 3}
:TRIGger:M1553:TYPE <type> (see page 572)	:TRIGger:M1553:TYPE? (see page 572)	<type> ::= {DSTART DSTOP CSTART CSTOP RTA PERROR SERROR MERROR RTA11}

:TRIGger:M1553:AUTOsetup

N (see [page 786](#))

Command Syntax :TRIGger:M1553:AUTOsetup

The :TRIGger:M1553:AUTOsetup command copies the position, volts/div, and probe attenuation from the upper threshold channel to the lower threshold channel, sets the upper/lower trigger levels to +/-500 mV, turns on serial decode, and sets the trigger mode to M1553.

- See Also**
- ["Introduction to :TRIGger Commands"](#) on page 467
 - [":TRIGger:MODE"](#) on page 473
 - [":TRIGger:M1553:SOURce:UPPer"](#) on page 571

:TRIGger:M1553:PATtern:DATA

N (see [page 786](#))

Command Syntax :TRIGger:M1553:PATtern:DATA <string>

<string> ::= "nn...n" where n ::= {0 | 1 | X}

The :TRIGger:M1553:PATtern:DATA command sets the 11 bits to trigger on if the trigger type has been set to RTA11 (RTA + 11 Bits) using the :TRIG:M1553:TYPE command.

Query Syntax :TRIGger:M1553:PATtern:DATA?

The :TRIGger:M1553:PATtern:DATA? query returns the current 11-bit setting.

Return Format <string><NL>

<string> ::= "nn...n" where n ::= {0 | 1 | X}

- See Also**
- "[Introduction to :TRIGger Commands](#)" on [page 467](#)
 - "[:TRIGger:M1553:TYPE](#)" on [page 572](#)

:TRIGger:M1553:RTA

N (see [page 786](#))

Command Syntax :TRIGger:M1553:RTA <value>
 <value> ::= 5-bit integer in decimal, <nondecimal>, or
 <string> from 0-31
 <nondecimal> ::= #Hnn where n ::= {0,...,9|A,...,F}
 <string> ::= "0xnn" where n ::= {0,...,9|A,...,F}

The :TRIGger:M1553:RTA command sets the Remote Terminal Address (RTA) to trigger on if the trigger type has been set to RTA using the :TRIG:M1553:TYPE command.

Query Syntax :TRIGger:M1553:RTA?

The :TRIGger:M1553:RTA? query returns the current TV trigger line number setting.

Return Format <value><NL> in nondecimal format

- See Also**
- "[Introduction to :TRIGger Commands](#)" on page 467
 - "[:TRIGger:M1553:TYPE](#)" on page 572

:TRIGger:M1553:SOURce:LOWer

N (see [page 786](#))

Command Syntax :TRIGger:M1553:SOURce:LOWer <source>
<source> ::= {CHANnel<n>}
<n> ::= {2 | 4}

The :TRIGger:M1553:SOURce:LOWer command controls which signal is used as the Lower Threshold Channel source by the serial decoder and/or trigger when in MIL-1553 mode.

Query Syntax :TRIGger:M1553:SOURce:LOWer?

The :TRIGger:M1553:SOURce:LOWer? query returns the currently set Lower Threshold Channel source.

Return Format <source><NL>
<source> ::= {CHAN<n>}
<n> ::= {2 | 4}

- See Also**
- ["Introduction to :TRIGger Commands"](#) on page 467
 - [":TRIGger:MODE"](#) on page 473
 - [":TRIGger:M1553:SOURce:UPPer"](#) on page 571

:TRIGger:M1553:SOURce:UPPer

N (see [page 786](#))

Command Syntax :TRIGger:M1553:SOURce:UPPer <source>

<source> ::= {CHANnel<n>}

<n> ::= {1 | 3}

The :TRIGger:M1553:SOURce:UPPer command controls which signal is used as the Upper Threshold Channel source by the serial decoder and/or trigger when in MIL-1553 mode.

Query Syntax :TRIGger:M1553:SOURce:UPPer?

The :TRIGger:M1553:SOURce:UPPer? query returns the currently set Upper Threshold Channel source.

Return Format <source><NL>

<source> ::= {CHAN<n>}

<n> ::= {1 | 3}

- See Also**
- ["Introduction to :TRIGger Commands"](#) on page 467
 - [":TRIGger:MODE"](#) on page 473
 - [":TRIGger:M1553:SOURce:LOWer"](#) on page 570

:TRIGger:M1553:TYPE

N (see page 786)

Command Syntax :TRIGger:M1553:TYPE <type>

```
<type> ::= {DSTart | DSTOp | CSTArt | CSTOp | RTA | PERRor | SERRor
           | MERRor | RTA11}
```

The :TRIGger:M1553:TYPE command specifies the type of MIL-STD 1553 trigger to be used:

- **DSTart** – (Data Word Start) triggers on the start of a Data word (at the end of a valid Data Sync pulse).
- **DSTOp** – (Data Word Stop) triggers on the end of a Data word.
- **CSTArt** – (Command/Status Word Start) triggers on the start of Command/Status word (at the end of a valid C/S Sync pulse).
- **CSTOp** – (Command/Status Word Stop) triggers on the end of a Command/Status word.
- **RTA** – (Remote Terminal Address) triggers if the RTA of the Command/Status word matches the specified value. The value is specified in hex.
- **RTA11** – (RTA + 11 Bits) triggers if the RTA and the remaining 11 bits match the specified criteria. The RTA can be specified as a hex value, and the remaining 11 bits can be specified as a 1, 0, or X (don't care).
- **PERRor** – (Parity Error) triggers if the (odd) parity bit is incorrect for the data in the word.
- **MERRor** – (Manchester Error) triggers if a Manchester encoding error is detected.
- **SERRor** – (Sync Error) triggers if an invalid Sync pulse is found.

Query Syntax :TRIGger:M1553:TYPE?

The :TRIGger:M1553:TYPE? query returns the currently set MIL-STD 1553 trigger type.

Return Format <type><NL>

```
<type> ::= {DSTA | DSTO | CSTA | CSTO | RTA | PERR | SERR
           | MERR | RTA11}
```

- See Also**
- "Introduction to :TRIGger Commands" on page 467
 - ":TRIGger:M1553:RTA" on page 569
 - ":TRIGger:M1553:PATtern:DATA" on page 568
 - ":TRIGger:MODE" on page 473

:TRIGger:SEQuence Commands

Table 88 :TRIGger:SEQuence Commands Summary

Command	Query	Options and Query Returns
:TRIGger:SEQuence:COU Nt <count> (see page 574)	:TRIGger:SEQuence:COU Nt? (see page 574)	<count> ::= integer in NR1 format
:TRIGger:SEQuence:EDG E{1 2} <source>, <slope> (see page 575)	:TRIGger:SEQuence:EDG E{1 2}? (see page 575)	<source> ::= {CHANnel<n> EXTernal} for the DSO models <source> ::= {CHANnel<n> DIGital0,...,DIGital15} for the MSO models <slope> ::= {POSitive NEGative} <n> ::= 1-2 or 1-4 in NR1 format <return_value> ::= query returns "NONE" if edge source is disabled
:TRIGger:SEQuence:FIN D <value> (see page 576)	:TRIGger:SEQuence:FIN D? (see page 576)	<value> ::= {PATtern1,ENTered PATtern1,EXITed EDGE1 PATtern1,AND,EDGE1}
:TRIGger:SEQuence:PAT Tern{1 2} <value>, <mask> (see page 577)	:TRIGger:SEQuence:PAT Tern{1 2}? (see page 577)	<value> ::= integer or <string> <mask> ::= integer or <string> <string> ::= "0xnxxxxn" n ::= {0,...,9 A,...,F}
:TRIGger:SEQuence:RES et <value> (see page 578)	:TRIGger:SEQuence:RES et? (see page 578)	<value> ::= {NONE PATtern1,ENTered PATtern1,EXITed EDGE1 PATtern1,AND,EDGE1 PATtern2,ENTered PATtern2,EXITed EDGE2 TIMer} Values used in find and trigger stages not available. EDGE2 not available if EDGE2,COUNT used in trigger stage.
:TRIGger:SEQuence:TIM er <time_value> (see page 579)	:TRIGger:SEQuence:TIM er? (see page 579)	<time_value> ::= time from 10 ns to 10 seconds in NR3 format
:TRIGger:SEQuence:TRI Gger <value> (see page 580)	:TRIGger:SEQuence:TRI Gger? (see page 580)	<value> ::= {PATtern2,ENTered PATtern2,EXITed EDGE2 PATtern2,AND,EDGE2 EDGE2,COUNT EDGE2,COUNT,NREFind}

:TRIGger:SEQuence:COUNT

N (see [page 786](#))

Command Syntax :TRIGger:SEQuence:COUNT <count>
<count> ::= integer in NR1 format

The :TRIGger:SEQuence:COUNT command sets the sequencer edge counter resource. The edge counter is used in the trigger stage to determine the number of edges that must be found before the sequencer generates a trigger.

Query Syntax :TRIGger:SEQuence:COUNT?

The :TRIGger:SEQuence:COUNT? query returns the current sequencer edge counter setting.

Return Format <count><NL>
<count> ::= integer in NR1 format

- See Also**
- ["Introduction to :TRIGger Commands"](#) on page 467
 - [":TRIGger:SEQuence:TRIGger"](#) on page 580
 - [":TRIGger:SEQuence:EDGE"](#) on page 575

:TRIGger:SEQuence:EDGE

N (see [page 786](#))

Command Syntax :TRIGger:SEQuence:EDGE{1 | 2} <source>, <slope>
 <source> ::= {CHANnel<n> | EXTernal} for the DSO models
 <source> ::= {CHANnel<n> | DIGital0,..,DIGital15} for the MSO models
 <slope> ::= {POSitive | NEGative}
 <n> ::= {1 | 2 | 3 | 4} for the four channel oscilloscope models
 <n> ::= {1 | 2} for the two channel oscilloscope models

The :TRIGger:SEQuence:EDGE<n> command defines the specified sequencer edge resource according to the specified <source> and <slope>. To disable an edge resource, set its <source> to NONE. In this case, <slope> has no meaning.

Query Syntax :TRIGger:SEQuence:EDGE{1 | 2}?

The :TRIGger:SEQuence:EDGE<n>? query returns the specified sequencer edge resource setting. If the edge resource is disabled, the returned <source> value is NONE. In this case, the <slope> is undefined.

Return Format <source>, <slope><NL>

- See Also**
- ["Introduction to :TRIGger Commands"](#) on page 467
 - [":TRIGger:SEQuence:FIND"](#) on page 576
 - [":TRIGger:SEQuence:TRIGger"](#) on page 580
 - [":TRIGger:SEQuence:RESet"](#) on page 578
 - [":TRIGger:SEQuence:COUNT"](#) on page 574

:TRIGger:SEQuence:FIND

N (see [page 786](#))

Command Syntax :TRIGger:SEQuence:FIND <value>
 <value> ::= {PATTern1,ENTered | PATTern1,EXITed | EDGE1
 | PATTern1,AND,EDGE1}

The :TRIGger:SEQuence:FIND command specifies the find stage of a sequence trigger. This command accepts three program data parameters; you can use NONE to fill out the parameter list (for example,"EDGE1,NONE,NONE").

PATTern1 is specified with the":TRIGger:SEQuence:PATTern command. EDGE1 is specified with the :TRIGger:SEQuence:EDGE command.

Query Syntax :TRIGger:SEQuence:FIND?

The :TRIGger:SEQuence:FIND? query returns the find stage specification for a sequence trigger. NONE is returned for unused parameters.

Return Format <find_value><NL>
 <find_value> ::= {PATT1,ENT,NONE | PATT1,EXIT,NONE | EDGE1,NONE,NONE
 | PATT1,AND,EDGE1}

- See Also**
- "[Introduction to :TRIGger Commands](#)" on page 467
 - "[:TRIGger:SEQuence:PATTern](#)" on page 577
 - "[:TRIGger:SEQuence:EDGE](#)" on page 575
 - "[:TRIGger:SEQuence:TRIGger](#)" on page 580
 - "[:TRIGger:SEQuence:RESet](#)" on page 578

:TRIGger:SEQuence:PATtern

N (see page 786)

Command Syntax :TRIGger:SEQuence:PATtern{1 | 2} <value>,<mask>
 <value> ::= integer or <string>
 <mask> ::= integer or <string>
 <string> ::= "0xnmmnnn" where n ::= {0,...,9 | A,...,F}

The :TRIGger:SEQuence:PATtern<n> command defines the specified sequence pattern resource according to the value and the mask. For both <value> and <mask>, each bit corresponds to a possible trigger channel. The bit assignments vary by instrument:

Oscilloscope Models	Value and Mask Bit Assignments
4 analog + 16 digital channels (mixed-signal)	Bits 0 through 15 - digital channels 0 through 15. Bits 16 through 19 - analog channels 1 through 4.
2 analog + 16 digital channels (mixed-signal)	Bits 0 through 15 - digital channels 0 through 15. Bits 16 and 17 - analog channels 1 and 2.
4 analog channels only	Bits 0 through 3 - analog channels 1 through 4. Bit 4 - external trigger.
2 analog channels only	Bits 0 and 1 - analog channels 1 and 2. Bit 4 - external trigger.

Set a <value> bit to "0" to set the pattern for the corresponding channel to low. Set a <value> bit to "1" to set the pattern to high.

Set a <mask> bit to "0" to ignore the data for the corresponding channel. Only channels with a "1" set on the appropriate mask bit are used.

Query Syntax :TRIGger:SEQuence:PATtern{1 | 2}?

The :TRIGger:SEQuence:PATtern<n>? query returns the current settings of the specified pattern resource.

Return Format <value>,<mask><NL>

- See Also**
- "Introduction to :TRIGger Commands" on page 467
 - ":TRIGger:SEQuence:FIND" on page 576
 - ":TRIGger:SEQuence:TRIGger" on page 580
 - ":TRIGger:SEQuence:RESet" on page 578

:TRIGger:SEQuence:RESet

N (see [page 786](#))

Command Syntax :TRIGger:SEQuence:RESet <value>

```
<value> ::= {NONE | PATTErn1,ENTERed | PATTErn1,EXITed | EDGE1
            | PATTErn1,AND,EDGE1 | PATTErn2,ENTERed | PATTErn2,EXITed
            | EDGE2 | TIMer}
```

Values used in find and trigger stages are not available. EDGE2 is not available if EDGE2,COUNT is used in trigger stage.

The :TRIGger:SEQuence:RESet command specifies the reset stage of a sequence trigger. In multi-level trigger specifications, you may find a pattern, then search for another in sequence, but reset the entire search to the beginning if another condition occurs. This command accepts three program data parameters; you can use NONE to fill out the parameter list (for example, "EDGE1,NONE,NONE").

PATTErn1 and PATTErn2 are specified with the :TRIGger:SEQuence:PATTErn command. EDGE1 and EDGE2 are specified with the :TRIGger:SEQuence:EDGE command. TIMer is specified with the :TRIGger:SEQuence:TIMer command.

Query Syntax :TRIGger:SEQuence:RESet?

The :TRIGger:SEQuence:RESet? query returns the reset stage specification for a sequence trigger. NONE is returned for unused parameters.

Return Format <reset_value><NL>

```
<reset_value> ::= {NONE,NONE,NONE | PATT1,ENT,NONE | PATT1,EXIT,NONE
                  | EDGE1,NONE,NONE | PATT1,AND,EDGE1 | PATT2,ENT,NONE
                  | PATT2,EXIT,NONE | EDGE2,NONE,NONE | TIM,NONE,NONE}
```

- See Also**
- ["Introduction to :TRIGger Commands"](#) on page 467
 - [":TRIGger:SEQuence:PATTErn"](#) on page 577
 - [":TRIGger:SEQuence:EDGE"](#) on page 575
 - [":TRIGger:SEQuence:TIMer"](#) on page 579
 - [":TRIGger:SEQuence:FIND"](#) on page 576
 - [":TRIGger:SEQuence:TRIGger"](#) on page 580

:TRIGger:SEQuence:TIMer

N (see [page 786](#))

Command Syntax :TRIGger:SEQuence:TIMer <time_value>

<time_value> ::= time in seconds in NR1 format

The :TRIGger:SEQuence:TIMer command sets the sequencer timer resource in seconds from 10 ns to 10 s. The timer is used in the reset stage to determine how long to wait for the trigger to occur before restarting.

Query Syntax :TRIGger:SEQuence:TIMer?

The :TRIGger:SEQuence:TIMer? query returns current sequencer timer setting.

Return Format <time value><NL>

<time_value> ::= time in seconds in NR1 format

- See Also**
- "[Introduction to :TRIGger Commands](#)" on page 467
 - "[:TRIGger:SEQuence:RESet](#)" on page 578

:TRIGger:SEQuence:TRIGger

N (see page 786)

Command Syntax :TRIGger:SEQuence:TRIGger <value>

```
<value> ::= {PATTern2,ENTerEd | PATTern2,EXITed | EDGE2
             | PATTern2,AND,EDGE2 | EDGE2,COUNT | EDGE2,COUNT,NREFind}
```

The :TRIGger:SEQuence:TRIGger command specifies the trigger stage of a sequence trigger. The sequence commands set various search terms. After all of these are found in sequence, the trigger condition itself is searched for. This command accepts three program data parameters; you can use NONE to fill out the parameter list (for example, "EDGE2,NONE,NONE").

PATTern2 is specified with the :TRIGger:SEQuence:PATTern command. EDGE2 is specified with the :TRIGger:SEQuence:EDGE command. COUNT is specified with the :TRIGger:SEQuence:COUNT command.

Query Syntax :TRIGger:SEQuence:TRIGger?

The :TRIGger:SEQuence:TRIGger? query returns the trigger stage specification for a sequence trigger. NONE is returned for unused parameters.

Return Format <trigger_value><NL>

```
<trigger_value> ::= {PATT2,ENT,NONE | PATT2,EXIT,NONE
                    | EDGE2,NONE,NONE | PATT2,AND,EDGE2
                    | EDGE2,COUN,NONE | EDGE2,COUN,NREF}
```

- See Also**
- "Introduction to :TRIGger Commands" on page 467
 - ":TRIGger:SEQuence:PATTern" on page 577
 - ":TRIGger:SEQuence:EDGE" on page 575
 - ":TRIGger:SEQuence:COUNT" on page 574
 - ":TRIGger:SEQuence:FIND" on page 576
 - ":TRIGger:SEQuence:RESet" on page 578
 - ":TRIGger:SEQuence:RESet" on page 578

:TRIGger:SPI Commands

Table 89 :TRIGger:SPI Commands Summary

Command	Query	Options and Query Returns
:TRIGger:SPI:CLOCK:SL OPe <slope> (see page 582)	:TRIGger:SPI:CLOCK:SL OPe? (see page 582)	<slope> ::= {NEGative POSitive}
:TRIGger:SPI:CLOCK:TI Meout <time_value> (see page 583)	:TRIGger:SPI:CLOCK:TI Meout? (see page 583)	<time_value> ::= time in seconds in NR1 format
:TRIGger:SPI:FRAMing <value> (see page 584)	:TRIGger:SPI:FRAMing? (see page 584)	<value> ::= {CHIPselect NOTChipselect TIMEout}
:TRIGger:SPI:PATtern: DATA <value>, <mask> (see page 585)	:TRIGger:SPI:PATtern: DATA? (see page 585)	<value> ::= integer or <string> <mask> ::= integer or <string> <string> ::= "0xnxxxxxx" where n ::= {0,...,9 A,...,F}
:TRIGger:SPI:PATtern: WIDTh <width> (see page 586)	:TRIGger:SPI:PATtern: WIDTh? (see page 586)	<width> ::= integer from 4 to 32 in NR1 format
:TRIGger:SPI:SOURce:C LOCK <source> (see page 587)	:TRIGger:SPI:SOURce:C LOCK? (see page 587)	<value> ::= {CHANnel<n> EXTernal} for the DSO models <value> ::= {CHANnel<n> DIGital0,...,DIGital15} for the MSO models <n> ::= 1-2 or 1-4 in NR1 format
:TRIGger:SPI:SOURce:D ATA <source> (see page 588)	:TRIGger:SPI:SOURce:D ATA? (see page 588)	<value> ::= {CHANnel<n> EXTernal} for the DSO models <value> ::= {CHANnel<n> DIGital0,...,DIGital15} for the MSO models <n> ::= 1-2 or 1-4 in NR1 format
:TRIGger:SPI:SOURce:F RAME <source> (see page 589)	:TRIGger:SPI:SOURce:F RAME? (see page 589)	<value> ::= {CHANnel<n> EXTernal} for the DSO models <value> ::= {CHANnel<n> DIGital0,...,DIGital15} for the MSO models <n> ::= 1-2 or 1-4 in NR1 format

:TRIGger:SPI:CLOCK:SLOPe

N (see [page 786](#))

Command Syntax :TRIGger:SPI:CLOCK:SLOPe <slope>
<slope> ::= {NEGative | POSitive}

The :TRIGger:SPI:CLOCK:SLOPe command specifies the rising edge (POSitive) or falling edge (NEGative) of the SPI clock source that will clock in the data.

Query Syntax :TRIGger:SPI:CLOCK:SLOPe?

The :TRIGger:SPI:CLOCK:SLOPe? query returns the current SPI clock source slope.

Return Format <slope><NL>
<slope> ::= {NEG | POS}

- See Also**
- ["Introduction to :TRIGger Commands"](#) on page 467
 - [":TRIGger:SPI:CLOCK:TIMEout"](#) on page 583
 - [":TRIGger:SPI:SOURce:CLOCK"](#) on page 587

:TRIGger:SPI:CLOCK:TIMEout

N (see [page 786](#))

Command Syntax :TRIGger:SPI:CLOCK:TIMEout <time_value>

<time_value> ::= time in seconds in NR1 format

The :TRIGger:SPI:CLOCK:TIMEout command sets the SPI signal clock timeout resource in seconds from 500 ns to 10 s when the :TRIGger:SPI:FRAMing command is set to TIMEout. The timer is used to frame a signal by a clock timeout.

Query Syntax :TRIGger:SPI:CLOCK:TIMEout?

The :TRIGger:SPI:CLOCK:TIMEout? query returns current SPI clock timeout setting.

Return Format <time value><NL>

<time_value> ::= time in seconds in NR1 format

- See Also**
- ["Introduction to :TRIGger Commands"](#) on page 467
 - [":TRIGger:SPI:CLOCK:SLOPe"](#) on page 582
 - [":TRIGger:SPI:SOURce:CLOCK"](#) on page 587
 - [":TRIGger:SPI:FRAMing"](#) on page 584

:TRIGger:SPI:FRAMing

N (see [page 786](#))

Command Syntax :TRIGger:SPI:FRAMing <value>

<value> ::= {CHIPselect | NOTChipselect | TIMEout}

The :TRIGger:SPI:FRAMing command sets the SPI trigger framing value. If TIMEout is selected, the timeout value is set by the :TRIGger:SPI:CLOCK:TIMEout command.

Query Syntax :TRIGger:SPI:FRAMing?

The :TRIGger:SPI:FRAMing? query returns the current SPI framing value.

Return Format <value><NL>

<value> ::= {CHIPselect | NOTChipselect | TIMEout}

- See Also**
- "[Introduction to :TRIGger Commands](#)" on page 467
 - "[:TRIGger:MODE](#)" on page 473
 - "[:TRIGger:SPI:CLOCK:TIMEout](#)" on page 583
 - "[:TRIGger:SPI:SOURce:FRAME](#)" on page 589

:TRIGger:SPI:PATtern:DATA

N (see [page 786](#))

Command Syntax :TRIGger:SPI:PATtern:DATA <value>,<mask>

<value> ::= integer or <string>

<mask> ::= integer or <string>

<string> ::= "0xnmmmmn" where n ::= {0,...,9 | A,...,F}

The :TRIGger:SPI:PATtern:DATA command defines the SPI data pattern resource according to the value and the mask. This pattern, along with the data width, control the data pattern searched for in the data stream.

Set a <value> bit to "0" to set the corresponding bit in the data pattern to low. Set a <value> bit to "1" to set the bit to high.

Set a <mask> bit to "0" to ignore that bit in the data stream. Only bits with a "1" set on the mask are used.

Query Syntax :TRIGger:SPI:PATtern:DATA?

The :TRIGger:SPI:PATtern:DATA? query returns the current settings of the specified SPI data pattern resource.

Return Format <value> , <mask><NL>

- See Also**
- ["Introduction to :TRIGger Commands"](#) on page 467
 - [":TRIGger:SPI:PATtern:WIDTh"](#) on page 586
 - [":TRIGger:SPI:SOURce:DATA"](#) on page 588

:TRIGger:SPI:PATtern:WIDTh

N (see [page 786](#))

Command Syntax :TRIGger:SPI:PATtern:WIDTh <width>
<width> ::= integer from 4 to 32 in NR1 format

The :TRIGger:SPI:PATtern:WIDTh command sets the width of the SPI data pattern anywhere from 4 bits to 32 bits.

Query Syntax :TRIGger:SPI:PATtern:WIDTh?

The :TRIGger:SPI:PATtern:WIDTh? query returns the current SPI data pattern width setting.

Return Format <width><NL>
<width> ::= integer from 4 to 32 in NR1 format

- See Also**
- "[Introduction to :TRIGger Commands](#)" on page 467
 - "[:TRIGger:SPI:PATtern:DATA](#)" on page 585
 - "[:TRIGger:SPI:SOURce:DATA](#)" on page 588

:TRIGger:SPI:SOURce:CLOCK

N (see [page 786](#))

Command Syntax :TRIGger:SPI:SOURce:CLOCK <source>

<source> ::= {CHANnel<n> | EXTernal} for the DSO models

<source> ::= {CHANnel<n> | DIGital0,...,DIGital15} for the MSO models

<n> ::= {1 | 2 | 3 | 4} for the four channel oscilloscope models

<n> ::= {1 | 2} for the two channel oscilloscope models

The :TRIGger:SPI:SOURce:CLOCK command sets the source for the SPI serial clock.

Query Syntax :TRIGger:SPI:SOURce:CLOCK?

The :TRIGger:SPI:SOURce:CLOCK? query returns the current source for the SPI serial clock.

Return Format <source><NL>

- See Also**
- ["Introduction to :TRIGger Commands"](#) on page 467
 - [":TRIGger:SPI:CLOCK:SLOPe"](#) on page 582
 - [":TRIGger:SPI:CLOCK:TIMEout"](#) on page 583
 - [":TRIGger:SPI:SOURce:FRAMe"](#) on page 589
 - [":TRIGger:SPI:SOURce:DATA"](#) on page 588

:TRIGger:SPI:SOURce:DATA

N (see [page 786](#))

Command Syntax :TRIGger:SPI:SOURce:DATA <source>

<source> ::= {CHANnel<n> | EXTernal} for the DSO models

<source> ::= {CHANnel<n> | DIGital0,...,DIGital15} for the MSO models

<n> ::= {1 | 2 | 3 | 4} for the four channel oscilloscope models

<n> ::= {1 | 2} for the two channel oscilloscope models

The :TRIGger:SPI:SOURce:DATA command sets the source for the SPI serial data.

Query Syntax :TRIGger:SPI:SOURce:DATA?

The :TRIGger:SPI:SOURce:DATA? query returns the current source for the SPI serial data.

Return Format <source><NL>

- See Also**
- ["Introduction to :TRIGger Commands"](#) on page 467
 - [":TRIGger:SPI:SOURce:CLOCK"](#) on page 587
 - [":TRIGger:SPI:SOURce:FRAMe"](#) on page 589
 - [":TRIGger:SPI:PATTern:DATA"](#) on page 585
 - [":TRIGger:SPI:PATTern:WIDTh"](#) on page 586

:TRIGger:SPI:SOURce:FRAME

N (see [page 786](#))

Command Syntax :TRIGger:SPI:SOURce:FRAME <source>

<source> ::= {CHANnel<n> | EXTernal} for the DSO models

<source> ::= {CHANnel<n> | DIGital0,...,DIGital15} for the MSO models

<n> ::= {1 | 2 | 3 | 4} for the four channel oscilloscope models

<n> ::= {1 | 2} for the two channel oscilloscope models

The :TRIGger:SPI:SOURce:FRAME command sets the frame source when :TRIGger:SPI:FRAMing is set to CHIPselect or NOTChipselect.

Query Syntax :TRIGger:SPI:SOURce:FRAME?

The :TRIGger:SPI:SOURce:FRAME? query returns the current frame source for the SPI serial frame.

Return Format <source><NL>

- See Also**
- ["Introduction to :TRIGger Commands"](#) on page 467
 - [":TRIGger:SPI:SOURce:CLOCK"](#) on page 587
 - [":TRIGger:SPI:SOURce:DATA"](#) on page 588
 - [":TRIGger:SPI:FRAMing"](#) on page 584

:TRIGger:TV Commands

Table 90 :TRIGger:TV Commands Summary

Command	Query	Options and Query Returns
:TRIGger:TV:LINE <line number> (see page 591)	:TRIGger:TV:LINE? (see page 591)	<line number> ::= integer in NR1 format
:TRIGger:TV:MODE <tv mode> (see page 592)	:TRIGger:TV:MODE? (see page 592)	<tv mode> ::= {FIELD1 FIELD2 AFIELDS ALINES LINE VERTICAL LFIELD1 LFIELD2 LALTERNATE LVERTICAL}
:TRIGger:TV:POLarity <polarity> (see page 593)	:TRIGger:TV:POLarity? (see page 593)	<polarity> ::= {POSitive NEGative}
:TRIGger:TV:SOURce <source> (see page 594)	:TRIGger:TV:SOURce? (see page 594)	<source> ::= {CHANnel<n>} <n> ::= 1-2 or 1-4 integer in NR1 format
:TRIGger:TV:STANdard <standard> (see page 595)	:TRIGger:TV:STANdard? (see page 595)	<standard> ::= {GENeric NTSC PALM PAL SECam {P480L60HZ P480} {P720L60HZ P720} {P1080L24HZ P1080} P1080L25HZ P1080L50HZ P1080L60HZ {I1080L50HZ I1080} I1080L60HZ}

:TRIGger:TV:LINE

N (see page 786)

Command Syntax :TRIGger:TV:LINE <line_number>

<line_number> ::= integer in NR1 format

The :TRIGger:TV:LINE command allows triggering on a specific line of video. The line number limits vary with the standard and mode, as shown in the following table.

Table 91 TV Trigger Line Number Limits

TV Standard	Mode				
	LINE	LField1	LField2	LALternate	VERTical
NTSC		1 to 263	1 to 262	1 to 262	
PAL		1 to 313	314 to 625	1 to 312	
PAL-M		1 to 263	264 to 525	1 to 262	
SECAM		1 to 313	314 to 625	1 to 312	
GENERIC		1 to 1024	1 to 1024		1 to 1024
P480L60HZ	1 to 525				
P720L60HZ	1 to 750				
P1080L24HZ	1 to 1125				
P1080L25HZ	1 to 1125				
P1080L50HZ	1 to 1125				
P1080L60HZ	1 to 1125				
I1080L50HZ	1 to 1125				
I1080L60HZ	1 to 1125				

Query Syntax :TRIGger:TV:LINE?

The :TRIGger:TV:LINE? query returns the current TV trigger line number setting.

Return Format <line_number><NL>

<line_number> ::= integer in NR1 format

- See Also**
- "Introduction to :TRIGger Commands" on page 467
 - ":TRIGger:TV:STANdard" on page 595
 - ":TRIGger:TV:MODE" on page 592

:TRIGger:TV:MODE

N (see [page 786](#))

Command Syntax :TRIGger:TV:MODE <mode>

```
<mode> ::= {FIEld1 | FIEld2 | AFIElds | ALINes | LINE | VERTical
            | LFIeld1 | LFIeld2 | LALTernate | LVERTical}
```

The :TRIGger:TV:MODE command selects the TV trigger mode and field. The LVERTical parameter is only available when :TRIGger:TV:STANdard is GENERic. The LALTernate parameter is not available when :TRIGger:TV:STANdard is GENERic.

Old forms for <mode> are accepted:

<mode>	Old Forms Accepted
FIEld1	F1
FIEld2	F2
AFIElds	ALLFields, ALLFLDS
ALINes	ALLLines
LFIeld1	LINEF1, LINEFIELD1
LFIeld2	LINEF2, LINEFIELD2
LALTernate	LINEAlt
LVERTical	LINEVert

Query Syntax :TRIGger:TV:MODE?

The :TRIGger:TV:MODE? query returns the TV trigger mode.

Return Format <value><NL>

```
<value> ::= {FIE1 | FIE2 | AFI | ALIN | LINE | VERT | LFI1 | LFI2
            | LALT | LVER}
```

- See Also**
- ["Introduction to :TRIGger Commands"](#) on page 467
 - [":TRIGger:TV:STANdard"](#) on page 595
 - [":TRIGger:MODE"](#) on page 473

:TRIGger:TV:POLarity

N (see [page 786](#))

Command Syntax :TRIGger:TV:POLarity <polarity>
<polarity> ::= {POSitive | NEGative}

The :TRIGger:TV:POLarity command sets the polarity for the TV trigger.

Query Syntax :TRIGger:TV:POLarity?

The :TRIGger:TV:POLarity? query returns the TV trigger polarity.

Return Format <polarity><NL>
<polarity> ::= {POS | NEG}

- See Also**
- ["Introduction to :TRIGger Commands"](#) on page 467
 - [":TRIGger:MODE"](#) on page 473
 - [":TRIGger:TV:SOURce"](#) on page 594

:TRIGger:TV:SOURce

N (see [page 786](#))

Command Syntax :TRIGger:TV:SOURce <source>

<source> ::= {CHANnel<n>}

<n> ::= {1 | 2 | 3 | 4} for the four channel oscilloscope models

<n> ::= {1 | 2} for the two channel oscilloscope models

The :TRIGger:TV:SOURce command selects the channel used to produce the trigger.

Query Syntax :TRIGger:TV:SOURce?

The :TRIGger:TV:SOURce? query returns the current TV trigger source.

Return Format <source><NL>

<source> ::= {CHAN<n>}

- See Also**
- ["Introduction to :TRIGger Commands"](#) on page 467
 - [":TRIGger:MODE"](#) on page 473
 - [":TRIGger:TV:POLarity"](#) on page 593

- Example Code**
- ["Example Code"](#) on page 504

:TRIGger:TV:STANdard

N (see page 786)

Command Syntax :TRIGger:TV:STANdard <standard>

```
<standard> ::= {GENeric | NTSC | PALM | PAL | SECam
                | {P480L60HZ | P480} | {P720L60HZ | P720}
                | {P1080L24HZ | P1080} | P1080L25HZ
                | P1080L50HZ | P1080L60HZ
                | {I1080L50HZ | I1080} | I1080L60HZ}
```

The :TRIGger:TV:STANdard command selects the video standard. GENeric mode is non-interlaced.

Query Syntax :TRIGger:TV:STANdard?

The :TRIGger:TV:STANdard? query returns the current TV trigger standard setting.

Return Format <standard><NL>

```
<standard> ::= {GEN | NTSC | PALM | PAL | SEC | P480L60HZ | P760L60HZ
                | P1080L24HZ | P1080L25HZ | P1080L50HZ | P1080L60HZ
                | I1080L50HZ | I1080L60HZ}
```

:TRIGger:UART Commands

Table 92 :TRIGger:UART Commands Summary

Command	Query	Options and Query Returns
:TRIGger:UART:BASE <base> (see page 598)	:TRIGger:UART:BASE? (see page 598)	<base> ::= {ASCIi HEX}
:TRIGger:UART:BAUDrate <baudrate> (see page 599)	:TRIGger:UART:BAUDrate? (see page 599)	<baudrate> ::= integer from 1200 to 3000000 in 100 b/s increments
:TRIGger:UART:BITorder <bitorder> (see page 600)	:TRIGger:UART:BITorder? (see page 600)	<bitorder> ::= {LSBFirst MSBFirst}
:TRIGger:UART:BURSt <value> (see page 601)	:TRIGger:UART:BURSt? (see page 601)	<value> ::= {OFF 1 to 4096 in NR1 format}
:TRIGger:UART:DATA <value> (see page 602)	:TRIGger:UART:DATA? (see page 602)	<value> ::= 8-bit integer from 0-255 (0x00-0xff) in decimal, <hexadecimal>, <binary>, or <quoted_string> format <hexadecimal> ::= #Hnn where n ::= {0,...,9 A,...,F} for hexadecimal <binary> ::= #Bnn...n where n ::= {0 1} for binary <quoted_string> ::= any of the 128 valid 7-bit ASCII characters (or standard abbreviations)
:TRIGger:UART:IDLE <time_value> (see page 603)	:TRIGger:UART:IDLE? (see page 603)	<time_value> ::= time from 1 us to 10 s in NR3 format
:TRIGger:UART:PARity <parity> (see page 604)	:TRIGger:UART:PARity? (see page 604)	<parity> ::= {EVEN ODD NONE}
:TRIGger:UART:POLarity <polarity> (see page 605)	:TRIGger:UART:POLarity? (see page 605)	<polarity> ::= {HIGH LOW}
:TRIGger:UART:QUALifier <value> (see page 606)	:TRIGger:UART:QUALifier? (see page 606)	<value> ::= {EQUAL NOTequal GREATERthan LESSthan}

Table 92 :TRIGger:UART Commands Summary (continued)

Command	Query	Options and Query Returns
:TRIGger:UART:SOURce: RX <source> (see page 607)	:TRIGger:UART:SOURce: RX? (see page 607)	<source> ::= {CHANnel<n> EXTErnal} for DSO models <source> ::= {CHANnel<n> DIGital0,...,DIGital15} for MSO models <n> ::= 1-2 or 1-4 in NR1 format
:TRIGger:UART:SOURce: TX <source> (see page 608)	:TRIGger:UART:SOURce: TX? (see page 608)	<source> ::= {CHANnel<n> EXTErnal} for DSO models <source> ::= {CHANnel<n> DIGital0,...,DIGital15} for MSO models <n> ::= 1-2 or 1-4 in NR1 format
:TRIGger:UART:TYPE <value> (see page 609)	:TRIGger:UART:TYPE? (see page 609)	<value> ::= {RSTArt RSTOp RDATA RD1 RD0 RDX PARityerror TSTArt TSTOp TDATA TD1 TD0 TDX}
:TRIGger:UART:WIDTh <width> (see page 610)	:TRIGger:UART:WIDTh? (see page 610)	<width> ::= {5 6 7 8 9}

:TRIGger:UART:BASE

N (see [page 786](#))

Command Syntax :TRIGger:UART:BASE <base>
<base> ::= {ASCIi | HEX}

The :TRIGger:UART:BASE command sets the front panel UART/RS232 trigger setup data selection option:

- ASCii – front panel data selection is from ASCII values.
- HEX – front panel data selection is from hexadecimal values.

The :TRIGger:UART:BASE setting does not affect the :TRIGger:UART:DATA command which can always set data values using ASCII or hexadecimal values.

NOTE

The :TRIGger:UART:BASE command is independent of the :SBUS:UART:BASE command which affects decode only.

Query Syntax :TRIGger:UART:BASE?

The :TRIGger:UART:BASE? query returns the current UART base setting.

Return Format <base><NL>
<base> ::= {ASC | HEX}

- See Also**
- "[Introduction to :TRIGger Commands](#)" on page 467
 - "[:TRIGger:MODE](#)" on page 473
 - "[:TRIGger:UART:DATA](#)" on page 602

:TRIGger:UART:BAUDrate

N (see [page 786](#))

Command Syntax :TRIGger:UART:BAUDrate <baudrate>

<baudrate> ::= integer from 1200 to 3000000 in 100 b/s increments

The :TRIGger:UART:BAUDrate command selects the bit rate (in bps) for the serial decoder and/or trigger when in UART mode. The baud rate can be set from 1200 b/s to 3 Mb/s in 100 b/s increments. If you enter a baud rate that is not divisible by 100 b/s, the baud rate is set to the nearest baud rate divisible by 100 b/s.

If the baud rate you select does not match the system baud rate, false triggers may occur.

Query Syntax :TRIGger:UART:BAUDrate?

The :TRIGger:UART:BAUDrate? query returns the current UART baud rate setting.

Return Format <baudrate><NL>

<baudrate> ::= integer from 1200 to 3000000 in 100 b/s increments

- See Also**
- ["Introduction to :TRIGger Commands"](#) on page 467
 - [":TRIGger:MODE"](#) on page 473
 - [":TRIGger:UART:TYPE"](#) on page 609

:TRIGger:UART:BITorder

N (see [page 786](#))

Command Syntax :TRIGger:UART:BITorder <bitorder>
<bitorder> ::= {LSBFirst | MSBFirst}

The :TRIGger:UART:BITorder command specifies the order of transmission used by the physical Tx and Rx input signals for the serial decoder and/or trigger when in UART mode. LSBFirst sets the least significant bit of each message "byte" as transmitted first. MSBFirst sets the most significant bit as transmitted first.

Query Syntax :TRIGger:UART:BITorder?

The :TRIGger:UART:BITorder? query returns the current UART bit order setting.

Return Format <bitorder><NL>
<bitorder> ::= {LSBF | MSBF}

- See Also**
- ["Introduction to :TRIGger Commands"](#) on page 467
 - [":TRIGger:MODE"](#) on page 473
 - [":TRIGger:UART:TYPE"](#) on page 609
 - [":TRIGger:UART:SOURce:RX"](#) on page 607
 - [":TRIGger:UART:SOURce:TX"](#) on page 608

:TRIGger:UART:BURSt

N (see [page 786](#))

Command Syntax :TRIGger:UART:BURSt <value>
 <value> ::= {OFF | 1 to 4096 in NR1 format}

The :TRIGger:UART:BURSt command selects the burst value (Nth frame after idle period) in the range 1 to 4096 or OFF, for the trigger when in UART mode.

Query Syntax :TRIGger:UART:BURSt?

The :TRIGger:UART:BURSt? query returns the current UART trigger burst value.

Return Format <value><NL>
 <value> ::= {OFF | 1 to 4096 in NR1 format}

- See Also**
- ["Introduction to :TRIGger Commands"](#) on page 467
 - [":TRIGger:MODE"](#) on page 473
 - [":TRIGger:UART:IDLE"](#) on page 603
 - [":TRIGger:UART:TYPE"](#) on page 609

:TRIGger:UART:DATA

N (see [page 786](#))

Command Syntax :TRIGger:UART:DATA <value>

<value> ::= 8-bit integer from 0-255 (0x00-0xff) in decimal,
 <hexadecimal>, <binary>, or <quoted_string> format

<hexadecimal> ::= #Hnn where n ::= {0,...,9 | A,...,F} for hexadecimal

<binary> ::= #Bnn...n where n ::= {0 | 1} for binary

<quoted_string> ::= any of the 128 valid 7-bit ASCII characters
 (or standard abbreviations)

The :TRIGger:UART:DATA command selects the data byte value (0x00 to 0xFF) for the trigger QUALifier when in UART mode. The data value is used when one of the RD or TD trigger types is selected.

When entering an ASCII character via the quoted string, it must be one of the 128 valid characters (case-sensitive): "NUL", "SOH", "STX", "ETX", "EOT", "ENQ", "ACK", "BEL", "BS", "HT", "LF", "VT", "FF", "CR", "SO", "SI", "DLE", "DC1", "DC2", "DC3", "DC4", "NAK", "SYN", "ETB", "CAN", "EM", "SUB", "ESC", "FS", "GS", "RS", "US", "SP", "!", "\", "#", "\$", "%", "&", "\", "(", ")", "*", "+", ",", "-", ".", "/", "0", "1", "2", "3", "4", "5", "6", "7", "8", "9", ":", ";", "<", "=", ">", "?", "@", "A", "B", "C", "D", "E", "F", "G", "H", "I", "J", "K", "L", "M", "N", "O", "P", "Q", "R", "S", "T", "U", "V", "W", "X", "Y", "Z", "[", "\\", "]", "^", "_", "`", "a", "b", "c", "d", "e", "f", "g", "h", "i", "j", "k", "l", "m", "n", "o", "p", "q", "r", "s", "t", "u", "v", "w", "x", "y", "z", "{", "|", "}", "~", or "DEL".

Query Syntax :TRIGger:UART:DATA?

The :TRIGger:UART:DATA? query returns the current UART trigger data value.

Return Format <value><NL>

<value> ::= 8-bit integer in decimal from 0-255

- See Also**
- "[Introduction to :TRIGger Commands](#)" on page 467
 - "[:TRIGger:MODE](#)" on page 473
 - "[:TRIGger:UART:BASE](#)" on page 598
 - "[:TRIGger:UART:TYPE](#)" on page 609

:TRIGger:UART:IDLE

N (see [page 786](#))

Command Syntax :TRIGger:UART:IDLE <time_value>

<time_value> ::= time from 1 us to 10 s in NR3 format

The :TRIGger:UART:IDLE command selects the value of the idle period for burst trigger in the range from 1 us to 10 s when in UART mode.

Query Syntax :TRIGger:UART:IDLE?

The :TRIGger:UART:IDLE? query returns the current UART trigger idle period time.

Return Format <time_value><NL>

<time_value> ::= time from 1 us to 10 s in NR3 format

- See Also**
- "[Introduction to :TRIGger Commands](#)" on page 467
 - "[:TRIGger:MODE](#)" on page 473
 - "[:TRIGger:UART:BURSt](#)" on page 601
 - "[:TRIGger:UART:TYPE](#)" on page 609

:TRIGger:UART:PARity

N (see [page 786](#))

Command Syntax :TRIGger:UART:PARity <parity>
<parity> ::= {EVEN | ODD | NONE}

The :TRIGger:UART:PARity command selects the parity to be used with each message "byte" for the serial decoder and/or trigger when in UART mode.

Query Syntax :TRIGger:UART:PARity?

The :TRIGger:UART:PARity? query returns the current UART parity setting.

Return Format <parity><NL>
<parity> ::= {EVEN | ODD | NONE}

- See Also**
- "[Introduction to :TRIGger Commands](#)" on page 467
 - "[:TRIGger:MODE](#)" on page 473
 - "[:TRIGger:UART:TYPE](#)" on page 609

:TRIGger:UART:POLarity

N (see [page 786](#))

Command Syntax :TRIGger:UART:POLarity <polarity>
 <polarity> ::= {HIGH | LOW}

The :TRIGger:UART:POLarity command selects the polarity as idle low or idle high for the serial decoder and/or trigger when in UART mode.

Query Syntax :TRIGger:UART:POLarity?

The :TRIGger:UART:POLarity? query returns the current UART polarity setting.

Return Format <polarity><NL>
 <polarity> ::= {HIGH | LOW}

- See Also**
- "[Introduction to :TRIGger Commands](#)" on page 467
 - "[:TRIGger:MODE](#)" on page 473
 - "[:TRIGger:UART:TYPE](#)" on page 609

:TRIGger:UART:QUALifier

N (see [page 786](#))

Command Syntax :TRIGger:UART:QUALifier <value>
<value> ::= {EQUAL | NOTequal | GREATERthan | LESSthan}

The :TRIGger:UART:QUALifier command selects the data qualifier when :TYPE is set to RDATA, RD1, RD0, RDX, TDATA, TD1, TD0, or TDX for the trigger when in UART mode.

Query Syntax :TRIGger:UART:QUALifier?

The :TRIGger:UART:QUALifier? query returns the current UART trigger qualifier.

Return Format <value><NL>
<value> ::= {EQU | NOT | GRE | LESS}

- See Also**
- ["Introduction to :TRIGger Commands"](#) on page 467
 - [":TRIGger:MODE"](#) on page 473
 - [":TRIGger:UART:TYPE"](#) on page 609

:TRIGger:UART:SOURce:RX

N (see [page 786](#))

Command Syntax :TRIGger:UART:SOURce:RX <source>

<source> ::= {CHANnel<n> | EXTernal} for the DSO models

<source> ::= {CHANnel<n> | DIGital0,...,DIGital15} for the MSO models

<n> ::= {1 | 2 | 3 | 4} for the four channel oscilloscope models

<n> ::= {1 | 2} for the two channel oscilloscope models

The :TRIGger:UART:SOURce:RX command controls which signal is used as the Rx source by the serial decoder and/or trigger when in UART mode.

Query Syntax :TRIGger:UART:SOURce:RX?

The :TRIGger:UART:SOURce:RX? query returns the current source for the UART Rx signal.

Return Format <source><NL>

- See Also**
- ["Introduction to :TRIGger Commands"](#) on page 467
 - [":TRIGger:MODE"](#) on page 473
 - [":TRIGger:UART:TYPE"](#) on page 609
 - [":TRIGger:UART:BITorder"](#) on page 600

:TRIGger:UART:SOURce:TX

N (see [page 786](#))

Command Syntax :TRIGger:UART:SOURce:TX <source>

<source> ::= {CHANnel<n> | EXTernal} for the DSO models

<source> ::= {CHANnel<n> | DIGital0,...,DIGital15} for the MSO models

<n> ::= {1 | 2 | 3 | 4} for the four channel oscilloscope models

<n> ::= {1 | 2} for the two channel oscilloscope models

The :TRIGger:UART:SOURce:TX command controls which signal is used as the Tx source by the serial decoder and/or trigger when in UART mode.

Query Syntax :TRIGger:UART:SOURce:TX?

The :TRIGger:UART:SOURce:TX? query returns the current source for the UART Tx signal.

Return Format <source><NL>

- See Also**
- ["Introduction to :TRIGger Commands"](#) on page 467
 - [":TRIGger:MODE"](#) on page 473
 - [":TRIGger:UART:TYPE"](#) on page 609
 - [":TRIGger:UART:BITorder"](#) on page 600

:TRIGger:UART:TYPE

N (see [page 786](#))

Command Syntax :TRIGger:UART:TYPE <value>

```
<value> ::= {RSTArt | RSTOp | RDATA | RD1 | RD0 | RDX | PARityerror
            | TSTArt | TSTOp | TDATa | TD1 | TD0 | TDX}
```

The :TRIGger:UART:TYPE command selects the UART trigger type.

When one of the RD or TD types is selected, the :TRIGger:UART:DATA and :TRIGger:UART:QUALifier commands are used to specify the data value and comparison operator.

The RD1, RD0, RDX, TD1, TD0, and TDX types (for triggering on data and alert bit values) are only valid when a 9-bit width has been selected.

Query Syntax :TRIGger:UART:TYPE?

The :TRIGger:UART:TYPE? query returns the current UART trigger data value.

Return Format <value><NL>

```
<value> ::= {RSTA | RSTO | RDAT | RD1 | RD0 | RDX | PAR | TSTA |
            TSTO | TDAT | TD1 | TD0 | TDX}
```

- See Also**
- ["Introduction to :TRIGger Commands"](#) on page 467
 - [":TRIGger:MODE"](#) on page 473
 - [":TRIGger:UART:DATA"](#) on page 602
 - [":TRIGger:UART:QUALifier"](#) on page 606
 - [":TRIGger:UART:WIDTH"](#) on page 610

:TRIGger:UART:WIDTH

N (see [page 786](#))

Command Syntax :TRIGger:UART:WIDTH <width>

<width> ::= {5 | 6 | 7 | 8 | 9}

The :TRIGger:UART:WIDTH command determines the number of bits (5-9) for each message "byte" for the serial decoder and/or trigger when in UART mode.

Query Syntax :TRIGger:UART:WIDTH?

The :TRIGger:UART:WIDTH? query returns the current UART width setting.

Return Format <width><NL>

<width> ::= {5 | 6 | 7 | 8 | 9}

- See Also**
- "[Introduction to :TRIGger Commands](#)" on page 467
 - "[:TRIGger:MODE](#)" on page 473
 - "[:TRIGger:UART:TYPE](#)" on page 609

:TRIGger:USB Commands

Table 93 :TRIGger:USB Commands Summary

Command	Query	Options and Query Returns
:TRIGger:USB:SOURce:D MINus <source> (see page 612)	:TRIGger:USB:SOURce:D MINus? (see page 612)	<source> ::= {CHANnel<n> EXTernal} for the DSO models <source> ::= {CHANnel<n> DIGital0,..,DIGital15} for the MSO models <n> ::= 1-2 or 1-4 in NR1 format
:TRIGger:USB:SOURce:D PLus <source> (see page 613)	:TRIGger:USB:SOURce:D PLus? (see page 613)	<source> ::= {CHANnel<n> EXTernal} for the DSO models <source> ::= {CHANnel<n> DIGital0,..,DIGital15} for the MSO models <n> ::= 1-2 or 1-4 in NR1 format
:TRIGger:USB:SPEEd <value> (see page 614)	:TRIGger:USB:SPEEd? (see page 614)	<value> ::= {LOW FULL}
:TRIGger:USB:TRIGger <value> (see page 615)	:TRIGger:USB:TRIGger? (see page 615)	<value> ::= {SOP EOP ENTersuspend EXITsuspend RESet}

:TRIGger:USB:SOURce:DMINus

N (see [page 786](#))

Command Syntax :TRIGger:USB:SOURce:DMINus <source>

<source> ::= {CHANnel<n> | EXTernal} for the DSO models

<source> ::= {CHANnel<n> | DIGital0,...,DIGital15} for the MSO models

<n> ::= {1 | 2 | 3 | 4} for the four channel oscilloscope models

<n> ::= {1 | 2} for the two channel oscilloscope models

The :TRIGger:USB:SOURce:DMINus command sets the source for the USB D- signal.

Query Syntax :TRIGger:USB:SOURce:DMINus?

The :TRIGger:USB:SOURce:DMINus? query returns the current source for the USB D- signal.

Return Format <source><NL>

- See Also**
- ["Introduction to :TRIGger Commands"](#) on page 467
 - [":TRIGger:MODE"](#) on page 473
 - [":TRIGger:USB:SOURce:DPLus"](#) on page 613
 - [":TRIGger:USB:TRIGger"](#) on page 615

:TRIGger:USB:SOURce:DPLus

N (see [page 786](#))

Command Syntax :TRIGger:USB:SOURce:DPLus <source>

<source> ::= {CHANnel<n> | EXTernal} for the DSO models

<source> ::= {CHANnel<n> | DIGital0,...,DIGital15} for the MSO models

<n> ::= {1 | 2 | 3 | 4} for the four channel oscilloscope models

<n> ::= {1 | 2} for the two channel oscilloscope models

The :TRIGger:USB:SOURce:DPLus command sets the source for the USB D+ signal.

Query Syntax :TRIGger:USB:SOURce:DPLus?

The :TRIGger:USB:SOURce:DPLus? query returns the current source for the USB D+ signal.

Return Format <source><NL>

- See Also**
- ["Introduction to :TRIGger Commands"](#) on page 467
 - [":TRIGger:MODE"](#) on page 473
 - [":TRIGger:USB:SOURce:DMINus"](#) on page 612
 - [":TRIGger:USB:TRIGger"](#) on page 615

:TRIGger:USB:SPEEd

N (see [page 786](#))

Command Syntax :TRIGger:USB:SPEEd <value>
<value> ::= {LOW | FULL}

The :TRIGger:USB:SPEEd command sets the expected USB signal speed to be Low Speed (1.5 Mb/s) or Full Speed (12 Mb/s).

Query Syntax :TRIGger:USB:SPEEd?

The :TRIGger:USB:SPEEd? query returns the current speed value for the USB signal.

Return Format <value><NL>

- See Also**
- ["Introduction to :TRIGger Commands"](#) on page 467
 - [":TRIGger:MODE"](#) on page 473
 - [":TRIGger:USB:SOURce:DMINus"](#) on page 612
 - [":TRIGger:USB:SOURce:DPLus"](#) on page 613
 - [":TRIGger:USB:TRIGger"](#) on page 615

:TRIGger:USB:TRIGger

N (see [page 786](#))

Command Syntax :TRIGger:USB:TRIGger <value>

<value> ::= {SOP | EOP | ENTersuspend | EXITsuspend | RESet}

The :TRIGger:USB:TRIGger command sets where the USB trigger will occur:

- SOP – Start of packet.
- EOP – End of packet.
- ENTersuspend – Enter suspend state.
- EXITsuspend – Exit suspend state.
- RESet – Reset complete.

Query Syntax :TRIGger:USB:TRIGger?

The :TRIGger:USB:TRIGger? query returns the current USB trigger value.

Return Format <value><NL>

<value> ::= {SOP | EOP | ENTersuspend | EXITsuspend | RESet}

- See Also**
- ["Introduction to :TRIGger Commands"](#) on page 467
 - [":TRIGger:MODE"](#) on page 473
 - [":TRIGger:USB:SPEed"](#) on page 614

:WAVEform Commands

Provide access to waveform data. See "Introduction to :WAVEform Commands" on page 618.

Table 94 :WAVEform Commands Summary

Command	Query	Options and Query Returns
:WAVEform:BYTeorder <value> (see page 624)	:WAVEform:BYTeorder? (see page 624)	<value> ::= {LSBFirst MSBFirst}
n/a	:WAVEform:COUNT? (see page 625)	<count> ::= an integer from 1 to 65536 in NR1 format
n/a	:WAVEform:DATA? (see page 626)	<binary block length bytes>, <binary data> For example, to transmit 1000 bytes of data, the syntax would be: #800001000<1000 bytes of data><NL> 8 is the number of digits that follow 00001000 is the number of bytes to be transmitted <1000 bytes of data> is the actual data
:WAVEform:FORMat <value> (see page 628)	:WAVEform:FORMat? (see page 628)	<value> ::= {WORD BYTE ASCII}
:WAVEform:POINTs <# points> (see page 629)	:WAVEform:POINTs? (see page 629)	<# points> ::= {100 250 500 1000 <points_mode>} if waveform points mode is NORMAl <# points> ::= {100 250 500 1000 2000 ... 8000000 in 1-2-5 sequence <points_mode>} if waveform points mode is MAXimum or RAW <points_mode> ::= {NORMAl MAXimum RAW}
:WAVEform:POINTs:MODE <points_mode> (see page 631)	:WAVEform:POINTs:MODE ? (see page 632)	<points_mode> ::= {NORMAl MAXimum RAW}

Table 94 :WAVEform Commands Summary (continued)

Command	Query	Options and Query Returns
n/a	:WAVEform:PREAmble? (see page 633)	<p><preamble_block> ::= <format NR1>, <type NR1>,<points NR1>,<count NR1>, <xincrement NR3>, <xorigin NR3>, <xreference NR1>,<yincrement NR3>, <yorigin NR3>, <yreference NR1></p> <p><format> ::= an integer in NR1 format:</p> <ul style="list-style-type: none"> • 0 for BYTE format • 1 for WORD format • 2 for ASCII format <p><type> ::= an integer in NR1 format:</p> <ul style="list-style-type: none"> • 0 for NORMAl type • 1 for PEAK detect type • 2 for AVERAge type • 3 for HRESolution type <p><count> ::= Average count, or 1 if PEAK detect type or NORMAl; an integer in NR1 format</p>
n/a	:WAVEform:SEGmented:COUNT? (see page 636)	<count> ::= an integer from 2 to 2000 in NR1 format (with Option SGM)
n/a	:WAVEform:SEGmented:TAG? (see page 637)	<time_tag> ::= in NR3 format (with Option SGM)
:WAVEform:SOURce <source> (see page 638)	:WAVEform:SOURce? (see page 638)	<p><source> ::= {CHANnel<n> FUNCTION MATH SBUS} for DSO models</p> <p><source> ::= {CHANnel<n> POD{1 2} BUS{1 2} FUNCTION MATH SBUS} for MSO models</p> <p><n> ::= 1-2 or 1-4 in NR1 format</p>
:WAVEform:SOURce:SUBSource <subsource> (see page 642)	:WAVEform:SOURce:SUBSource? (see page 642)	<subsource> ::= {{NONE RX} TX}
n/a	:WAVEform:TYPE? (see page 643)	<return_mode> ::= {NORM PEAK AVER HRES}
:WAVEform:UNSigned {{0 OFF} {1 ON}} (see page 644)	:WAVEform:UNSigned? (see page 644)	{0 1}
:WAVEform:VIEW <view> (see page 645)	:WAVEform:VIEW? (see page 645)	<view> ::= {MAIN}

Table 94 :WAVeform Commands Summary (continued)

Command	Query	Options and Query Returns
n/a	:WAVeform:XINCrement? (see page 646)	<return_value> ::= x-increment in the current preamble in NR3 format
n/a	:WAVeform:XORigin? (see page 647)	<return_value> ::= x-origin value in the current preamble in NR3 format
n/a	:WAVeform:XREFerence? (see page 648)	<return_value> ::= 0 (x-reference value in the current preamble in NR1 format)
n/a	:WAVeform:YINCrement? (see page 649)	<return_value> ::= y-increment value in the current preamble in NR3 format
n/a	:WAVeform:YORigin? (see page 650)	<return_value> ::= y-origin in the current preamble in NR3 format
n/a	:WAVeform:YREFerence? (see page 651)	<return_value> ::= y-reference value in the current preamble in NR1 format

Introduction to :WAVeform Commands

The WAVeform subsystem is used to transfer data to a controller from the oscilloscope waveform memories. The queries in this subsystem will only operate when the channel selected by :WAVeform:SOURce is on.

Waveform Data and Preamble

The waveform record is actually contained in two portions: the preamble and waveform data. The waveform record must be read from the oscilloscope by the controller using two separate commands, :WAVeform:DATA (see [page 626](#)) and :WAVeform:PREamble (see [page 633](#)). The waveform data is the actual data acquired for each point in the specified source. The preamble contains the information for interpreting the waveform data, which includes the number of points acquired, the format of acquired data, and the type of acquired data. The preamble also contains the X and Y increments, origins, and references for the acquired data, so that word and byte data can be translated to time and voltage values.

Data Acquisition Types

There are four types of waveform acquisitions that can be selected for analog channels with the :ACquire:TYPE command (see [page 196](#)): NORMal, AVERage, PEAK, and HRESolution. Digital channels are always

acquired using NORMal. When the data is acquired using the :DIGitize command (see [page 150](#)) or :RUN command (see [page 174](#)), the data is placed in the channel buffer of the specified source.

Once you have acquired data with the :DIGitize command, the instrument is stopped. If the instrument is restarted (via the programming interface or the front panel), or if any instrument setting is changed, the data acquired with the :DIGitize command may be overwritten. You should first acquire the data with the :DIGitize command, then immediately read the data with the :WAVEform:DATA? query (see [page 626](#)) before changing any instrument setup.

A waveform record consists of either all of the acquired points or a subset of the acquired points. The number of points acquired may be queried using :ACQUIRE:POINTS? (see [page 188](#)).

Helpful Hints:

The number of points transferred to the computer is controlled using the :WAVEform:POINTS command (see [page 629](#)). If :WAVEform:POINTS MAXimum is specified and the instrument is not running (stopped), all of the points that are displayed are transferred. This can be as many as 4,000,000 in some operating modes or as many as 8,000,000 for a digital channel on the mixed signal oscilloscope. Fewer points may be specified to speed data transfers and minimize controller analysis time. The :WAVEform:POINTS may be varied even after data on a channel is acquired. However, this decimation may result in lost pulses and transitions. The number of points selected for transfer using :WAVEform:POINTS must be an even divisor of 1,000 or be set to MAXimum. :WAVEform:POINTS determines the increment between time buckets that will be transferred. If POINTS = MAXimum, the data cannot be decimated. For example:

- :WAVEform:POINTS 1000 – returns time buckets 0, 1, 2, 3, 4 ,,, 999.
- :WAVEform:POINTS 500 – returns time buckets 0, 2, 4, 6, 8 ,,, 998.
- :WAVEform:POINTS 250 – returns time buckets 0, 4, 8, 12, 16 ,,, 996.
- :WAVEform:POINTS 100 – returns time buckets 0, 10, 20, 30, 40 ,,, 990.

Analog Channel Data

NORMAL Data

Normal data consists of the last data point (hit) in each time bucket. This data is transmitted over the programming interface in a linear fashion starting with time bucket 0 and going through time bucket $n - 1$, where n is the number returned by the :WAVEform:POINTS? query (see [page 629](#)). Only the magnitude values of each data point are transmitted. The first voltage value corresponds to the first time bucket on the left side of the

screen and the last value corresponds to the next-to-last time bucket on the right side of the screen. Time buckets without data return 0. The time values for each data point correspond to the position of the data point in the data array. These time values are not transmitted.

AVERage Data

AVERage data consists of the average of the first *n* hits in a time bucket, where *n* is the value returned by the :ACQUIRE:COUNT query (see [page 185](#)). Time buckets that have fewer than *n* hits return the average of the data they do have. If a time bucket does not have any data in it, it returns 0.

This data is transmitted over the interface linearly, starting with time bucket 0 and proceeding through time bucket *n*-1, where *n* is the number returned by the :WAVEFORM:POINTS? query (see [page 629](#)). The first value corresponds to a point at the left side of the screen and the last value corresponds to one point away from the right side of the screen. The maximum number of points that can be returned in average mode is 1000 unless ACQUIRE:COUNT has been set to 1.

PEAK Data

Peak detect display mode is used to detect glitches for time base settings of 500 us/div and slower. In this mode, the oscilloscope can sample more data than it can store and display. So, when peak detect is turned on, the oscilloscope scans through the extra data, picks up the minimum and maximum for each time bucket, then stores the data in an array. Each time bucket contains two data sample.

The array is transmitted over the interface bus linearly, starting with time bucket 0 proceeding through time bucket *n*-1, where *n* is the number returned by the :WAVEFORM:POINTS? query (see [page 629](#)). In each time bucket, two values are transmitted, first the minimum, followed by the maximum. The first pair of values corresponds to the time bucket at the leftmost side of the screen. The last pair of values corresponds to the time bucket at the far right side of the screen. In :ACQUIRE:TYPE PEAK mode (see [page 196](#)), the value returned by the :WAVEFORM:XINcrement query (see [page 646](#)) should be doubled to find the time difference between the min-max pairs.

HRESolution Data

The high resolution (*smoothing*) mode is used to reduce noise at slower sweep speeds where the digitizer samples faster than needed to fill memory for the displayed time range.

Data Conversion

Word or byte data sent from the oscilloscope must be scaled for useful interpretation. The values used to interpret the data are the X and Y references, X and Y origins, and X and Y increments. These values are read from the waveform preamble. Each channel has its own waveform preamble.

In converting a data value to a voltage value, the following formula is used:

$$\text{voltage} = [(\text{data value} - \text{yreference}) * \text{yincrement}] + \text{yorigin}$$

If the :WAVEform:FORMat data format is ASCII (see [page 628](#)), the data values are converted internally and sent as floating point values separated by commas.

In converting a data value to time, the time value of a data point can be determined by the position of the data point. For example, the fourth data point sent with :WAVEform:XORigin = 16 ns, :WAVEform:XREFerence = 0, and :WAVEform:XINCrement = 2 ns, can be calculated using the following formula:

$$\text{time} = [(\text{data point number} - \text{xreference}) * \text{xincrement}] + \text{xorigin}$$

This would result in the following calculation for time bucket 3:

$$\text{time} = [(3 - 0) * 2 \text{ ns}] + 16 \text{ ns} = 22 \text{ ns}$$

In :ACQUIRE:TYPE PEAK mode (see [page 196](#)), because data is acquired in max-min pairs, modify the previous time formula to the following:

$$\text{time} = [(\text{data pair number} - \text{xreference}) * \text{xincrement} * 2] + \text{xorigin}$$

Data Format for Transfer

There are three formats for transferring waveform data over the interface: BYTE, WORD and ASCII (see ":WAVEform:FORMat" on [page 628](#)). BYTE, WORD and ASCII formatted waveform records are transmitted using the arbitrary block program data format specified in IEEE 488.2.

When you use the block data format, the ASCII character string "#8<DD...D>" is sent prior to sending the actual data. The 8 indicates how many Ds follow. The Ds are ASCII numbers that indicate how many data bytes follow.

For example, if 1000 points will be transferred, and the WORD format was specified, the block header "#800001000" would be sent. The 8 indicates that eight length bytes follow, and 00001000 indicates that 1000 binary data bytes follow.

Use the `:WAVEform:UNSIGNED` command (see [page 644](#)) to control whether data values are sent as unsigned or signed integers. This command can be used to match the instrument's internal data type to the data type used by the programming language. This command has no effect if the data format is ASCII.

Data Format for Transfer - ASCII format

The ASCII format (see `:WAVEform:FORMat` on [page 628](#)) provides access to the waveform data as real Y-axis values without using Y origin, Y reference, and Y increment to convert the binary data. Values are transferred as ASCII digits in floating point format separated by commas. In ASCII format, holes are represented by the value $9.9e+37$. The setting of `:WAVEform:BYTeorder` (see [page 624](#)) and `:WAVEform:UNSIGNED` (see [page 644](#)) have no effect when the format is ASCII.

Data Format for Transfer - WORD format

WORD format (see `:WAVEform:FORMat` on [page 628](#)) provides 16-bit access to the waveform data. In the WORD format, the number of data bytes is twice the number of data points. The number of data points is the value returned by the `:WAVEform:POINts?` query (see [page 629](#)). If the data intrinsically has less than 16 bits of resolution, the data is left-shifted to provide 16 bits of resolution and the least significant bits are set to 0. Currently, the greatest intrinsic resolution of any data is 12 bits, so at least the lowest 4 bits of data will be 0. If there is a hole in the data, the hole is represented by a 16 bit value equal to 0.

Use `:WAVEform:BYTeorder` (see [page 624](#)) to determine if the least significant byte or most significant byte is to be transferred first. The `:BYTeorder` command can be used to alter the transmit sequence to match the storage sequence of an integer in the programming language being used.

Data Format for Transfer - BYTE format

The BYTE format (see `:WAVEform:FORMat` on [page 628](#)) allows 8-bit access to the waveform data. If the data intrinsically has more than 8 bits of resolution (averaged data), the data is right-shifted (truncated) to fit into 8 bits. If there is a hole in the data, the hole is represented by a value of 0. The BYTE-formatted data transfers over the programming interface faster than ASCII or WORD-formatted data, because in ASCII format, as many as 13 bytes per point are transferred, in BYTE format one byte per point is transferred, and in WORD format two bytes per point are transferred.

The `:WAVEform:BYTeorder` command (see [page 624](#)) has no effect when the data format is BYTE.

Digital Channel Data (MSO models only)

The waveform record for digital channels is similar to that of analog channels. The main difference is that the data points represent either DIGital0,...,7 (POD1), DIGital8,...,15 (POD2), or any grouping of digital channels (BUS1 or BUS2).

For digital channels, :WAVeform:UNSigned (see page 644) must be set to ON.

Digital Channel POD Data Format

Data for digital channels is only available in groups of 8 bits (Pod1 = D0 - D7, Pod2 = D8 - D15). The bytes are organized as:

:WAVeform:SOURce	Bit 7	Bit 6	Bit 5	Bit 4	Bit 3	Bit 2	Bit 1	Bit 0
POD1	D7	D6	D5	D4	D3	D2	D1	D0
POD2	D15	D14	D13	D12	D11	D10	D9	D8

If the :WAVeform:FORMat is WORD (see page 628) is WORD, every other data byte will be 0. The setting of :WAVeform:BYTeorder (see page 624) controls which byte is 0.

If a digital channel is not displayed, its bit value in the pod data byte is not defined.

Digital Channel BUS Data Format

Digital channel BUS definitions can include any or all of the digital channels. Therefore, data is always returned as 16-bit values. :BUS commands (see page 198) are used to select the digital channels for a bus.

Reporting the Setup

The following is a sample response from the :WAVeform? query. In this case, the query was issued following a *RST command.

```
:WAV:UNS 1;VIEW MAIN;BYT MSBF;FORM BYTE;POIN +1000;SOUR CHAN1;SOUR:SUBS NONE
```

:WAVeform:BYTeorder

C (see [page 786](#))

Command Syntax :WAVeform:BYTeorder <value>
<value> ::= {LSBFirst | MSBFirst}

The :WAVeform:BYTeorder command sets the output sequence of the WORD data. The parameter MSBFirst sets the most significant byte to be transmitted first. The parameter LSBFirst sets the least significant byte to be transmitted first. This command affects the transmitting sequence only when :WAVeform:FORMat WORD is selected. The default setting is LSBFirst.

Query Syntax :WAVeform:BYTeorder?

The :WAVeform:BYTeorder query returns the current output sequence.

Return Format <value><NL>
<value> ::= {LSBF | MSBF}

- See Also**
- ["Introduction to :WAVeform Commands"](#) on page 618
 - [":WAVeform:DATA"](#) on page 626
 - [":WAVeform:FORMat"](#) on page 628
 - [":WAVeform:PREamble"](#) on page 633

- Example Code**
- ["Example Code"](#) on page 639
 - ["Example Code"](#) on page 634

:WAVeform:COUNT

C (see [page 786](#))

Query Syntax :WAVeform:COUNT?

The :WAVeform:COUNT? query returns the count used to acquire the current waveform. This may differ from current values if the unit has been stopped and its configuration modified. For all acquisition types except average, this value is 1.

Return Format <count_argument><NL>

<count_argument> ::= an integer from 1 to 65536 in NR1 format

- See Also**
- ["Introduction to :WAVeform Commands"](#) on page 618
 - [":ACQUIRE:COUNT"](#) on page 185
 - [":ACQUIRE:TYPE"](#) on page 196

:WAVeform:DATA

C (see [page 786](#))

Query Syntax :WAVeform:DATA?

The :WAVeform:DATA query returns the binary block of sampled data points transmitted using the IEEE 488.2 arbitrary block data format. The binary data is formatted according to the settings of the :WAVeform:UNSigned, :WAVeform:BYTeorder, :WAVeform:FORMat, and :WAVeform:SOURce commands. The number of points returned is controlled by the :WAVeform:POINts command.

In BYTE or WORD waveform formats, these data values have special meaning:

- 0x00 or 0x0000 – Hole. Holes are locations where data has not yet been acquired. Holes can be reasonably expected in the equivalent time acquisition mode (especially at slower horizontal sweep speeds when measuring low frequency signals).

Another situation where there can be zeros in the data, incorrectly, is when programming over telnet port 5024. Port 5024 provides a command prompt and is intended for ASCII transfers. Use telnet port 5025 instead.

- 0x01 or 0x0001 – Clipped low. These are locations where the waveform is clipped at the bottom of the oscilloscope display.
- 0xFF or 0xFFFF – Clipped high. These are locations where the waveform is clipped at the top of the oscilloscope display.

Return Format <binary block data><NL>

- See Also**
- For a more detailed description of the data returned for different acquisition types, see: "[Introduction to :WAVeform Commands](#)" on page 618
 - "[:WAVeform:UNSigned](#)" on page 644
 - "[:WAVeform:BYTeorder](#)" on page 624
 - "[:WAVeform:FORMat](#)" on page 628
 - "[:WAVeform:POINts](#)" on page 629
 - "[:WAVeform:PREamble](#)" on page 633
 - "[:WAVeform:SOURce](#)" on page 638
 - "[:WAVeform:TYPE](#)" on page 643

Example Code

```
' QUERY_WAVE_DATA - Outputs waveform data that is stored in a buffer.
' Query the oscilloscope for the waveform data.
myScope.WriteString ":WAV:DATA?"

' READ_WAVE_DATA - The wave data consists of two parts: the header,
```

```

' and the actual waveform data followed by a new line (NL) character.
' The query data has the following format:
'
'   <header><waveform_data><NL>
'
' Where:
'   <header> = #800001000 (This is an example header)
' The "#8" may be stripped off of the header and the remaining
' numbers are the size, in bytes, of the waveform data block. The
' size can vary depending on the number of points acquired for the
' waveform. You can then read that number of bytes from the
' oscilloscope and the terminating NL character.
'
Dim lngI As Long
Dim lngDataValue As Long

varQueryResult = myScope.ReadIEEEBlock(BinaryType_UI1)
' Unsigned integer bytes.
For lngI = 0 To UBound(varQueryResult) - 1
    Step (UBound(varQueryResult) / 20) ' 20 points.
    If intBytesPerData = 2 Then
        lngDataValue = varQueryResult(lngI) * 256 _
            + varQueryResult(lngI + 1) ' 16-bit value.
    Else
        lngDataValue = varQueryResult(lngI) ' 8-bit value.
    End If
    strOutput = strOutput + "Data point " + lngI + " = " + _
        CStr(lngDataValue) + ", " + _
        FormatNumber((lngDataValue - lngYReference) / _
            * sngYIncrement + sngYOrigin) + " V, " + _
        FormatNumber(((lngI / intBytesPerData - lngXReference) / _
            * sngXIncrement + dblXOrigin) * 1000000) + " us" + vbCrLf
Next lngI
MsgBox "Waveform data:" + vbCrLf + strOutput

```

Example program from the start: ["VISA COM Example in Visual Basic"](#) on page 812

:WAVeform:FORMat

C (see [page 786](#))

Command Syntax :WAVeform:FORMat <value>
 <value> ::= {WORD | BYTE | ASCii}

The :WAVeform:FORMat command sets the data transmission mode for waveform data points. This command controls how the data is formatted when sent from the oscilloscope.

- ASCii formatted data converts the internal integer data values to real Y-axis values. Values are transferred as ASCii digits in floating point notation, separated by commas.

ASCII formatted data is transferred ASCII text.

- WORD formatted data transfers 16-bit data as two bytes. The :WAVeform:BYTeorder command can be used to specify whether the upper or lower byte is transmitted first. The default (no command sent) is that the upper byte transmitted first.
- BYTE formatted data is transferred as 8-bit bytes.

When the :WAVeform:SOURce is the serial decode bus (SBUS), ASCii is the only waveform format allowed.

When the :WAVeform:SOURce is one of the digital channel buses (BUS1 or BUS2), ASCii and WORD are the only waveform formats allowed.

Query Syntax :WAVeform:FORMat?

The :WAVeform:FORMat query returns the current output format for the transfer of waveform data.

Return Format <value><NL>
 <value> ::= {WORD | BYTE | ASC}

- See Also**
- ["Introduction to :WAVeform Commands"](#) on page 618
 - [":WAVeform:BYTeorder"](#) on page 624
 - [":WAVeform:SOURce"](#) on page 638
 - [":WAVeform:DATA"](#) on page 626
 - [":WAVeform:PREamble"](#) on page 633

Example Code • ["Example Code"](#) on page 639

:WAVeform:POINts**C** (see [page 786](#))

Command Syntax :WAVeform:POINts <# points>

```
<# points> ::= {100 | 250 | 500 | 1000 | <points mode>}
              if waveform points mode is NORMAl

<# points> ::= {100 | 250 | 500 | 1000 | 2000 | 5000 | 10000 | 20000
              | 50000 | 100000 | 200000 | 500000 | 1000000 | 2000000
              | 4000000 | 8000000 | <points mode>}
              if waveform points mode is MAXimum or RAW

<points mode> ::= {NORMAl | MAXimum | RAW}
```

NOTE

The <points_mode> option is deprecated. Use the :WAVeform:POINts:MODE command instead.

The :WAVeform:POINts command sets the number of waveform points to be transferred with the :WAVeform:DATA? query. This value represents the points contained in the waveform selected with the :WAVeform:SOURce command.

For the analog or digital sources, the records that can be transferred depend on the waveform points mode. The maximum number of points returned for math (function) waveforms is determined by the NORMAl waveform points mode. See the :WAVeform:POINts:MODE command (see [page 631](#)) for more information.

Only data visible on the display will be returned.

When the :WAVeform:SOURce is the serial decode bus (SBUS), this command is ignored, and all available serial decode bus data is returned.

Query Syntax :WAVeform:POINts?

The :WAVeform:POINts query returns the number of waveform points to be transferred when using the :WAVeform:DATA? query. Setting the points mode will affect what data is transferred (see the :WAVeform:POINts:MODE command (see [page 631](#)) for more information).

When the :WAVeform:SOURce is the serial decode bus (SBUS), this query returns the number of messages that were decoded.

Return Format <# points><NL>

```
<# points> ::= {100 | 250 | 500 | 1000 | <maximum # points>}
              if waveform points mode is NORMAl

<# points> ::= {100 | 250 | 500 | 1000 | 2000 | 5000 | 10000 | 20000
              | 50000 | 100000 | 200000 | 500000 | 1000000 | 2000000
              | 4000000 | 8000000 | <maximum # points>}
              if waveform points mode is MAXimum or RAW
```

NOTE

If a full screen of data is not displayed, the number of points returned will not be 1000 or an even divisor of it.

- See Also**
- ["Introduction to :WAVEform Commands"](#) on page 618
 - [":ACQUIRE:POINTS"](#) on page 188
 - [":WAVEform:DATA"](#) on page 626
 - [":WAVEform:SOURce"](#) on page 638
 - [":WAVEform:VIEW"](#) on page 645
 - [":WAVEform:PREamble"](#) on page 633
 - [":WAVEform:POINTS:MODE"](#) on page 631

Example Code

```
' WAVE_POINTS - Specifies the number of points to be transferred  
' using the ":WAVEFORM:DATA?" query.  
myScope.WriteString ":WAVEFORM:POINTS 1000"
```

Example program from the start: ["VISA COM Example in Visual Basic"](#) on page 812

:WAVeform:POINts:MODE

N (see [page 786](#))

Command Syntax :WAVeform:POINts:MODE <points_mode>

<points_mode> ::= {NORMal | MAXimum | RAW}

The :WAVeform:POINts:MODE command sets the data record to be transferred with the :WAVeform:DATA? query.

For the analog or digital sources, there are three different records that can be transferred:

- The first is the raw acquisition record. The maximum number of points available in this record is returned by the :ACQuire:POINts? query. The raw acquisition record can only be transferred when the oscilloscope is not running and can only be retrieved from the analog or digital sources.
- The second is referred to as the *measurement record* and is a 1000-point (maximum) representation of the raw acquisition record. The measurement record can be retrieved when :SYSTem:PRECision is OFF, from any source.
- The third is referred to as the *precision analysis record* and is a 128K-point (maximum) representation of the raw acquisition record. The precision analysis record can be retrieved when :SYSTem:PRECision is ON, from analog sources.

If the <points_mode> is NORMal and :SYSTem:PRECision is OFF, the measurement record is retrieved.

If the <points_mode> is NORMal and :SYSTem:PRECision is ON, the precision analysis record is retrieved.

If the <points_mode> is RAW, the raw acquisition record is used. Under some conditions, such as when the oscilloscope is running, this data record is unavailable.

If the <points_mode> is MAXimum, whichever record contains the maximum amount of points is used. Usually, this is the raw acquisition record. But, if the raw acquisition record is unavailable (for example, when the oscilloscope is running), or if the reconstruction filter (Sin(x)/x interpolation) is in use, the measurement record may have more data. If data is being retrieved as the oscilloscope is stopped and as the data displayed is changing, the data being retrieved can switch between the measurement and raw acquisition records.

**Considerations
for MAXimum or
RAW data
retrieval**

- The instrument must be stopped (see the :STOP command (see [page 178](#)) or the :DIGitize command (see [page 150](#)) in the root subsystem) in order to return more than the *measurement record* or *precision analysis record*.

- :TIMEbase:MODE must be set to MAIN.
- :ACQUIRE:TYPE must be set to NORMAL, AVERAGE, or HRESOLUTION. If AVERAGE, :ACQUIRE:COUNT must be set to 1 in order to return more than the *measurement record* or *precision analysis record*.
- MAXimum or RAW will allow up to 8,000,000 points to be returned. The number of points returned will vary as the instrument's configuration is changed. Use the :WAVEform:POINTS? MAXimum query to determine the maximum number of points that can be retrieved at the current settings.

Query Syntax :WAVEform:POINTs:MODE?

The :WAVEform:POINTs:MODE? query returns the current points mode. Setting the points mode will affect what data is transferred. See the discussion above.

Return Format <points_mode><NL>

<points_mode> ::= {NORMAL | MAXimum | RAW}

- See Also**
- ["Introduction to :WAVEform Commands"](#) on page 618
 - [":WAVEform:DATA"](#) on page 626
 - [":ACQUIRE:POINTs"](#) on page 188
 - [":SYSTEM:PRECision"](#) on page 450
 - [":WAVEform:VIEW"](#) on page 645
 - [":WAVEform:PREamble"](#) on page 633
 - [":WAVEform:POINTs"](#) on page 629
 - [":TIMEbase:MODE"](#) on page 457
 - [":ACQUIRE:TYPE"](#) on page 196
 - [":ACQUIRE:COUNt"](#) on page 185

:WAVeform:PREamble

C (see [page 786](#))

Query Syntax :WAVeform:PREamble?

The :WAVeform:PREamble query requests the preamble information for the selected waveform source. The preamble data contains information concerning the vertical and horizontal scaling of the data of the corresponding channel.

Return Format <preamble_block><NL>

```
<preamble_block> ::= <format 16-bit NR1>,
                    <type 16-bit NR1>,
                    <points 32-bit NR1>,
                    <count 32-bit NR1>,
                    <xincrement 64-bit floating point NR3>,
                    <xorigin 64-bit floating point NR3>,
                    <xreference 32-bit NR1>,
                    <yincrement 32-bit floating point NR3>,
                    <yorigin 32-bit floating point NR3>,
                    <yreference 32-bit NR1>
```

<format> ::= 0 for BYTE format, 1 for WORD format, 4 for ASCII format;
an integer in NR1 format (format set by :WAVeform:FORMat).

<type> ::= 2 for AVERage type, 0 for NORMAl type, 1 for PEAK detect
type; an integer in NR1 format (type set by :ACQuire:TYPE).

<count> ::= Average count or 1 if PEAK or NORMAl; an integer in NR1
format (count set by :ACQuire:COUNT).

5 Commands by Subsystem

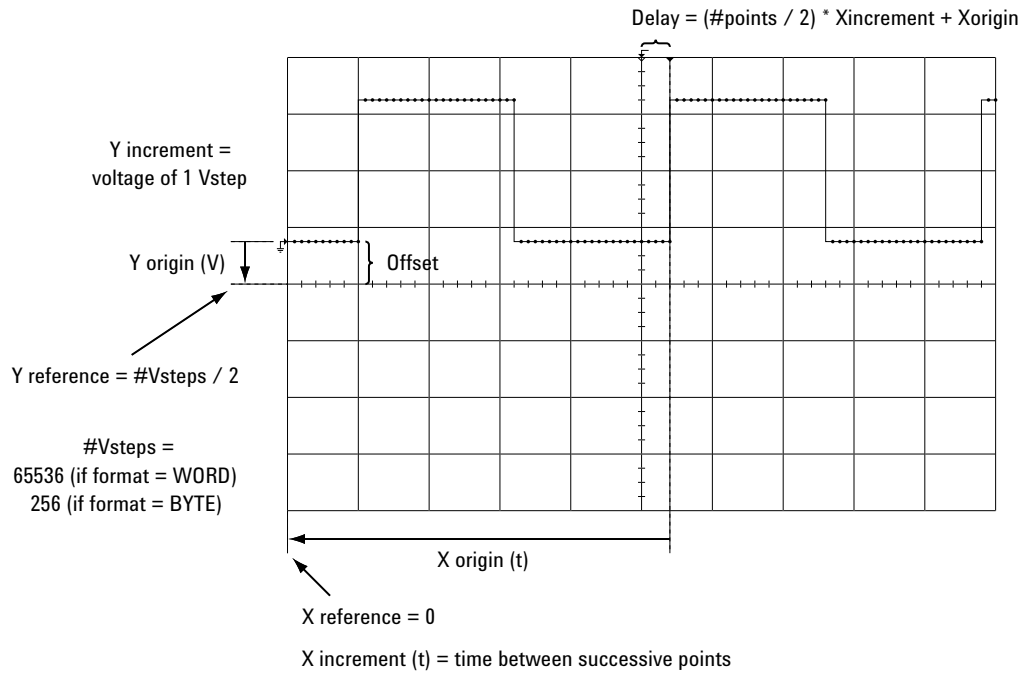

- See Also**
- "[Introduction to :WAVEform Commands](#)" on page 618
 - "[:ACquire:COUNT](#)" on page 185
 - "[:ACquire:POINTs](#)" on page 188
 - "[:ACquire:TYPE](#)" on page 196
 - "[:DIGitize](#)" on page 150
 - "[:WAVEform:COUNT](#)" on page 625
 - "[:WAVEform:DATA](#)" on page 626
 - "[:WAVEform:FORMat](#)" on page 628
 - "[:WAVEform:POINTs](#)" on page 629
 - "[:WAVEform:TYPE](#)" on page 643
 - "[:WAVEform:XINCrement](#)" on page 646
 - "[:WAVEform:XORigin](#)" on page 647
 - "[:WAVEform:XREFerence](#)" on page 648
 - "[:WAVEform:YINCrement](#)" on page 649
 - "[:WAVEform:YORigin](#)" on page 650
 - "[:WAVEform:YREFerence](#)" on page 651

Example Code

```
' GET_PREAMBLE - The preamble block contains all of the current
' WAVEFORM settings. It is returned in the form <preamble_block><NL>
' where <preamble_block> is:
'   FORMAT          : int16 - 0 = BYTE, 1 = WORD, 4 = ASCII.
```

```

'     TYPE           : int16 - 0 = NORMAL, 1 = PEAK DETECT, 2 = AVERAGE
'     POINTS        : int32 - number of data points transferred.
'     COUNT         : int32 - 1 and is always 1.
'     XINCREMENT    : float64 - time difference between data points.
'     XORIGIN       : float64 - always the first data point in memory.
'     XREFERENCE    : int32 - specifies the data point associated with
'                   x-origin.
'     YINCREMENT    : float32 - voltage diff between data points.
'     YORIGIN       : float32 - value is the voltage at center screen.
'     YREFERENCE    : int32 - specifies the data point where y-origin
'                   occurs.
Dim Preamble()
Dim intFormat As Integer
Dim intType As Integer
Dim lngPoints As Long
Dim lngCount As Long
Dim dblXIncrement As Double
Dim dblXOrigin As Double
Dim lngXReference As Long
Dim sngYIncrement As Single
Dim sngYOrigin As Single
Dim lngYReference As Long
Dim strOutput As String

myScope.WriteString ":WAVEFORM:PREAMBLE?" ' Query for the preamble.
Preamble() = myScope.ReadList ' Read preamble information.
intFormat = Preamble(0)
intType = Preamble(1)
lngPoints = Preamble(2)
lngCount = Preamble(3)
dblXIncrement = Preamble(4)
dblXOrigin = Preamble(5)
lngXReference = Preamble(6)
sngYIncrement = Preamble(7)
sngYOrigin = Preamble(8)
lngYReference = Preamble(9)

```

Example program from the start: ["VISA COM Example in Visual Basic"](#) on page 812

:WAVeform:SEGMented:COUNT

N (see [page 786](#))

Query Syntax :WAVeform:SEGMented:COUNT?

NOTE

This command is available when the segmented memory option (Option SGM) is enabled.

The :WAVeform:SEGMented:COUNT query returns the number of memory segments in the acquired data. You can use the :WAVeform:SEGMented:COUNT? query while segments are being acquired (although :DIGitize blocks subsequent queries until the full segmented acquisition is complete).

The segmented memory acquisition mode is enabled with the :ACQUIRE:MODE command. The number of segments to acquire is set using the :ACQUIRE:SEGMented:COUNT command, and data is acquired using the :DIGitize, :SINGLE, or :RUN commands.

Return Format <count> ::= an integer from 2 to 2000 in NR1 format (count set by :ACQUIRE:SEGMented:COUNT).

- See Also**
- [":ACQUIRE:MODE"](#) on page 187
 - [":ACQUIRE:SEGMented:COUNT"](#) on page 191
 - [":DIGitize"](#) on page 150
 - [":SINGLE"](#) on page 176
 - [":RUN"](#) on page 174
 - ["Introduction to :WAVeform Commands"](#) on page 618

Example Code • ["Example Code"](#) on page 192

:WAVeform:SEGmented:TTAG**N** (see [page 786](#))**Query Syntax** :WAVeform:SEGmented:TTAG?**NOTE**

This command is available when the segmented memory option (Option SGM) is enabled.

The :WAVeform:SEGmented:TTAG? query returns the time tag of the currently selected segmented memory index. The index is selected using the :ACQuire:SEGmented:INdEx command.

Return Format <time_tag> ::= in NR3 format

- See Also**
- [":ACQuire:SEGmented:INdEx"](#) on page 192
 - ["Introduction to :WAVeform Commands"](#) on page 618

Example Code • ["Example Code"](#) on page 192

:WAVeform:SOURce

C (see [page 786](#))

Command Syntax :WAVeform:SOURce <source>

<source> ::= {CHANnel<n> | FUNCTION | MATH | SBUS} for DSO models

<source> ::= {CHANnel<n> | POD{1 | 2} | BUS{1 | 2} | FUNCTION
| MATH | SBUS} for MSO models

<n> ::= {1 | 2 | 3 | 4} for the four channel oscilloscope models

<n> ::= {1 | 2} for the two channel oscilloscope models

The :WAVeform:SOURce command selects the analog channel, function, digital pod, digital bus, or serial decode bus to be used as the source for the :WAVeform commands.

Function capabilities include add, subtract, multiply; integrate, differentiate, and FFT (Fast Fourier Transform) operations.

When the :WAVeform:SOURce is the serial decode bus (SBUS), ASCii is the only waveform format allowed.

With MSO oscilloscope models, you can choose a POD or BUS as the waveform source. There are some differences between POD and BUS when formatting and getting data from the oscilloscope:

- When POD1 or POD2 is selected as the waveform source, you can choose the BYTE, WORD, or ASCii formats (see [":WAVeform:FORMat"](#) on [page 628](#)).

When the WORD format is chosen, every other data byte will be 0. The setting of :WAVeform:BYTeorder controls which byte is 0.

When the ASCii format is chosen, the :WAVeform:DATA? query returns a string with unsigned decimal values separated by commas.

- When BUS1 or BUS2 is selected as the waveform source, you can choose the WORD or ASCii formats (but not BYTE because bus values are always returned as 16-bit values).

When the ASCii format is chosen, the :WAVeform:DATA? query returns a string with timestamps and hexadecimal bus values, for example:
-5.000000000000e-08,0x1938,-4.990000000000e-08,0xff38,...

Query Syntax :WAVeform:SOURce?

The :WAVeform:SOURce? query returns the currently selected source for the WAVeform commands.

NOTE

MATH is an alias for FUNCTION. The :WAVeform:SOURce? Query returns FUNC if the source is FUNCTION or MATH.

Return Format

```

<source><NL>
<source> ::= {CHAN<n> | FUNC | SBUS} for DSO models
<source> ::= {CHAN<n> | POD{1 | 2} | BUS{1 | 2} | FUNC | SBUS}
              for MSO models
<n> ::= {1 | 2 | 3 | 4} for the four channel oscilloscope models
<n> ::= {1 | 2} for the two channel oscilloscope models
    
```

- See Also**
- ["Introduction to :WAVEform Commands" on page 618](#)
 - [":DIGitize" on page 150](#)
 - [":WAVEform:FORMat" on page 628](#)
 - [":WAVEform:BYTeorder" on page 624](#)
 - [":WAVEform:DATA" on page 626](#)
 - [":WAVEform:PREamble" on page 633](#)

Example Code

```

' WAVEFORM_DATA - To obtain waveform data, you must specify the
' WAVEFORM parameters for the waveform data prior to sending the
' ":WAVEFORM:DATA?" query. Once these parameters have been sent,
' the waveform data and the preamble can be read.
'
' WAVE_SOURCE - Selects the channel to be used as the source for
' the waveform commands.
myScope.WriteString ":WAVEFORM:SOURCE CHAN1"

' WAVE_POINTS - Specifies the number of points to be transferred
' using the ":WAVEFORM:DATA?" query.
myScope.WriteString ":WAVEFORM:POINTS 1000"

' WAVE_FORMAT - Sets the data transmission mode for the waveform
' data output. This command controls whether data is formatted in
' a word or byte format when sent from the oscilloscope.
Dim lngVSteps As Long
Dim intBytesPerData As Integer

' Data in range 0 to 65535.
myScope.WriteString ":WAVEFORM:FORMAT WORD"
lngVSteps = 65536
intBytesPerData = 2

' Data in range 0 to 255.
myScope.WriteString ":WAVEFORM:FORMAT BYTE"
lngVSteps = 256
intBytesPerData = 1

' GET_PREAMBLE - The preamble block contains all of the current
' WAVEFORM settings. It is returned in the form <preamble_block><NL>
' where <preamble_block> is:
'   FORMAT          : int16 - 0 = BYTE, 1 = WORD, 4 = ASCII.
'   TYPE            : int16 - 0 = NORMAL, 1 = PEAK DETECT, 2 = AVERAGE
'   POINTS          : int32 - number of data points transferred.
'   COUNT           : int32 - 1 and is always 1.
'   XINCREMENT      : float64 - time difference between data points.
    
```

5 Commands by Subsystem

```
' XORIGIN      : float64 - always the first data point in memory.
' XREFERENCE   : int32 - specifies the data point associated with
'              x-origin.
' YINCREMENT   : float32 - voltage diff between data points.
' YORIGIN      : float32 - value is the voltage at center screen.
' YREFERENCE   : int32 - specifies the data point where y-origin
'              occurs.
Dim Preamble()
Dim intFormat As Integer
Dim intType As Integer
Dim lngPoints As Long
Dim lngCount As Long
Dim dblXIncrement As Double
Dim dblXOrigin As Double
Dim lngXReference As Long
Dim sngYIncrement As Single
Dim sngYOrigin As Single
Dim lngYReference As Long
Dim strOutput As String

myScope.WriteString ":WAVEFORM:PREAMBLE?" ' Query for the preamble.
Preamble() = myScope.ReadList ' Read preamble information.
intFormat = Preamble(0)
intType = Preamble(1)
lngPoints = Preamble(2)
lngCount = Preamble(3)
dblXIncrement = Preamble(4)
dblXOrigin = Preamble(5)
lngXReference = Preamble(6)
sngYIncrement = Preamble(7)
sngYOrigin = Preamble(8)
lngYReference = Preamble(9)
strOutput = ""
'strOutput = strOutput + "Format = " + CStr(intFormat) + vbCrLf
'strOutput = strOutput + "Type = " + CStr(intType) + vbCrLf
'strOutput = strOutput + "Points = " + CStr(lngPoints) + vbCrLf
'strOutput = strOutput + "Count = " + CStr(lngCount) + vbCrLf
'strOutput = strOutput + "X increment = " + _
'             FormatNumber(dblXIncrement * 1000000) + " us" + vbCrLf
'strOutput = strOutput + "X origin = " + _
'             FormatNumber(dblXOrigin * 1000000) + " us" + vbCrLf
'strOutput = strOutput + "X reference = " + _
'             CStr(lngXReference) + vbCrLf
'strOutput = strOutput + "Y increment = " + _
'             FormatNumber(sngYIncrement * 1000) + " mV" + vbCrLf
'strOutput = strOutput + "Y origin = " + _
'             FormatNumber(sngYOrigin) + " V" + vbCrLf
'strOutput = strOutput + "Y reference = " + _
'             CStr(lngYReference) + vbCrLf
strOutput = strOutput + "Volts/Div = " + _
'             FormatNumber(lngVSteps * sngYIncrement / 8) + _
'             " V" + vbCrLf
strOutput = strOutput + "Offset = " + _
'             FormatNumber((lngVSteps / 2 - lngYReference) * _
'             sngYIncrement + sngYOrigin) + " V" + vbCrLf
strOutput = strOutput + "Sec/Div = " + _
'             FormatNumber(lngPoints * dblXIncrement / 10 * _
```



```

        1000000) + " us" + vbCrLf
strOutput = strOutput + "Delay = " + _
        FormatNumber(((lngPoints / 2 - lngXReference) * _
        dblXIncrement + dblXOrigin) * 1000000) + " us" + vbCrLf

' QUERY_WAVE_DATA - Outputs waveform data that is stored in a buffer.

' Query the oscilloscope for the waveform data.
myScope.WriteString ":WAV:DATA?"

' READ_WAVE_DATA - The wave data consists of two parts: the header,
' and the actual waveform data followed by a new line (NL) character.
' The query data has the following format:
'
'   <header><waveform_data><NL>
'
' Where:
'   <header> = #800001000 (This is an example header)
' The "#8" may be stripped off of the header and the remaining
' numbers are the size, in bytes, of the waveform data block. The
' size can vary depending on the number of points acquired for the
' waveform. You can then read that number of bytes from the
' oscilloscope and the terminating NL character.
'
Dim lngI As Long
Dim lngDataValue As Long

' Unsigned integer bytes.
varQueryResult = myScope.ReadIEEEBlock(BinaryType_UI1)

For lngI = 0 To UBound(varQueryResult) _
    Step (UBound(varQueryResult) / 20) ' 20 points.
    If intBytesPerData = 2 Then
        lngDataValue = varQueryResult(lngI) * 256 _
            + varQueryResult(lngI + 1) ' 16-bit value.
    Else
        lngDataValue = varQueryResult(lngI) ' 8-bit value.
    End If
    strOutput = strOutput + "Data point " + _
        CStr(lngI / intBytesPerData) + ", " + _
        FormatNumber((lngDataValue - lngYReference) _
            * sngYIncrement + sngYOrigin) + " V, " + _
        FormatNumber(((lngI / intBytesPerData - lngXReference) _
            * sngXIncrement + dblXOrigin) * 1000000) + " us" + vbCrLf
Next lngI
MsgBox "Waveform data:" + vbCrLf + strOutput

```

Example program from the start: ["VISA COM Example in Visual Basic"](#) on page 812

:WAVeform:SOURce:SUBSource

C (see [page 786](#))

Command Syntax :WAVeform:SOURce:SUBSource <subsource>

<subsource> ::= {{NONE | RX} | TX}

If the :WAVeform:SOURce is SBUS (serial decode), more than one data set may be available, and this command lets you choose from the available data sets.

Currently, only UART serial decode lets you get "TX" data. The default, NONE, specifies "RX" data. (RX is an alias for NONE.)

If the :WAVeform:SOURce is not SBUS, or the :SBUS:MODE is not UART, the only valid subsource is NONE.

Query Syntax :WAVeform:SOURce:SUBSource?

The :WAVeform:SOURce:SUBSource? query returns the current waveform subsource setting.

Return Format <subsource><NL>

<subsource> ::= {NONE | TX}

- See Also**
- ["Introduction to :WAVeform Commands"](#) on page 618
 - [":WAVeform:SOURce"](#) on page 638

:WAVeform:TYPE

C (see [page 786](#))

Query Syntax :WAVeform:TYPE?

The :WAVeform:TYPE? query returns the acquisition mode associated with the currently selected waveform. The acquisition mode is set by the :ACQUIRE:TYPE command.

Return Format <mode><NL>

<mode> ::= {NORM | PEAK | AVER | HRES}

NOTE

If the :WAVeform:SOURce is POD1, POD2, or SBUS, the type is always NORM.

-
- See Also**
- "[Introduction to :WAVeform Commands](#)" on page 618
 - "[:ACQUIRE:TYPE](#)" on page 196
 - "[:WAVeform:DATA](#)" on page 626
 - "[:WAVeform:PREamble](#)" on page 633
 - "[:WAVeform:SOURce](#)" on page 638

:WAVeform:UNSigned

C (see [page 786](#))

Command Syntax :WAVeform:UNSigned <unsigned>
<unsigned> ::= {{0 | OFF} | {1 | ON}}

The :WAVeform:UNSigned command turns unsigned mode on or off for the currently selected waveform. Use the WAVeform:UNSigned command to control whether data values are sent as unsigned or signed integers. This command can be used to match the instrument's internal data type to the data type used by the programming language. This command has no effect if the data format is ASCII.

If :WAVeform:SOURce is set to POD1, POD2, BUS1, or BUS2, WAVeform:UNSigned must be set to ON.

Query Syntax :WAVeform:UNSigned?

The :WAVeform:UNSigned? query returns the status of unsigned mode for the currently selected waveform.

Return Format <unsigned><NL>
<unsigned> ::= {0 | 1}

- See Also**
- ["Introduction to :WAVeform Commands"](#) on page 618
 - [":WAVeform:SOURce"](#) on page 638

:WAVeform:VIEW

C (see [page 786](#))

Command Syntax :WAVeform:VIEW <view>

<view> ::= {MAIN}

The :WAVeform:VIEW command sets the view setting associated with the currently selected waveform. Currently, the only legal value for the view setting is MAIN.

Query Syntax :WAVeform:VIEW?

The :WAVeform:VIEW? query returns the view setting associated with the currently selected waveform.

Return Format <view><NL>

<view> ::= {MAIN}

- See Also**
- "[Introduction to :WAVeform Commands](#)" on page 618
 - "[:WAVeform:POINTs](#)" on page 629

:WAVeform:XINCrement

C (see [page 786](#))

Query Syntax :WAVeform:XINCrement?

The :WAVeform:XINCrement? query returns the x-increment value for the currently specified source. This value is the time difference between consecutive data points in seconds.

Return Format <value><NL>

<value> ::= x-increment in the current preamble in 64-bit floating point NR3 format

- See Also**
- "[Introduction to :WAVeform Commands](#)" on page 618
 - "[:WAVeform:PREamble](#)" on page 633

Example Code

- "[Example Code](#)" on page 634

:WAVeform:XORigin

C (see [page 786](#))

Query Syntax :WAVeform:XORigin?

The :WAVeform:XORigin? query returns the x-origin value for the currently specified source. XORigin is the X-axis value of the data point specified by the :WAVeform:XREFerence value. In this product, that is always the X-axis value of the first data point (XREFerence = 0).

Return Format <value><NL>

<value> ::= x-origin value in the current preamble in 64-bit floating point NR3 format

- See Also**
- "[Introduction to :WAVeform Commands](#)" on page 618
 - "[:WAVeform:PREamble](#)" on page 633
 - "[:WAVeform:XREFerence](#)" on page 648

- Example Code**
- "[Example Code](#)" on page 634

:WAVeform:XREFerence

C (see [page 786](#))

Query Syntax :WAVeform:XREFerence?

The :WAVeform:XREFerence? query returns the x-reference value for the currently specified source. This value specifies the index of the data point associated with the x-origin data value. In this product, the x-reference point is the first point displayed and XREFerence is always 0.

Return Format <value><NL>

<value> ::= x-reference value = 0 in 32-bit NR1 format

- See Also**
- "[Introduction to :WAVeform Commands](#)" on page 618
 - "[:WAVeform:PREamble](#)" on page 633
 - "[:WAVeform:XORigin](#)" on page 647

- Example Code**
- "[Example Code](#)" on page 634

:WAVeform:YINCrement

C (see [page 786](#))

Query Syntax :WAVeform:YINCrement?

The :WAVeform:YINCrement? query returns the y-increment value in volts for the currently specified source. This value is the voltage difference between consecutive data values. The y-increment for digital waveforms is always "1".

Return Format <value><NL>

<value> ::= y-increment value in the current preamble in 32-bit floating point NR3 format

- See Also**
- ["Introduction to :WAVeform Commands"](#) on page 618
 - [":WAVeform:PREamble"](#) on page 633

Example Code

- ["Example Code"](#) on page 634

:WAVeform:YORigin

C (see [page 786](#))

Query Syntax :WAVeform:YORigin?

The :WAVeform:YORigin? query returns the y-origin value for the currently specified source. This value is the Y-axis value of the data value specified by the :WAVeform:YREFerence value. For this product, this is the Y-axis value of the center of the screen.

Return Format <value><NL>

<value> ::= y-origin in the current preamble in 32-bit floating point NR3 format

- See Also**
- ["Introduction to :WAVeform Commands"](#) on page 618
 - [":WAVeform:PREamble"](#) on page 633
 - [":WAVeform:YREFerence"](#) on page 651

- Example Code**
- ["Example Code"](#) on page 634

:WAVeform:YREFerence

C (see [page 786](#))

Query Syntax :WAVeform:YREFerence?

The :WAVeform:YREFerence? query returns the y-reference value for the currently specified source. This value specifies the data point value where the y-origin occurs. In this product, this is the data point value of the center of the screen. It is undefined if the format is ASCii.

Return Format <value><NL>

<value> ::= y-reference value in the current preamble in 32-bit NR1 format

- See Also**
- ["Introduction to :WAVeform Commands"](#) on page 618
 - [":WAVeform:PREamble"](#) on page 633
 - [":WAVeform:YORigin"](#) on page 650

- Example Code**
- ["Example Code"](#) on page 634

5 Commands by Subsystem

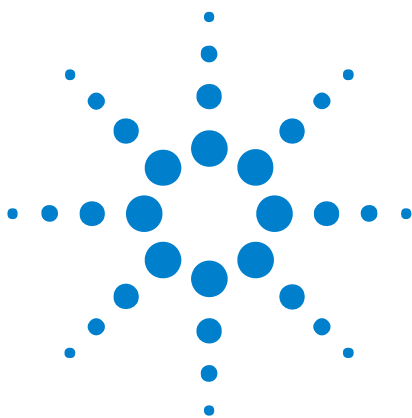

6 Commands A-Z

A	653
B	655
C	655
D	658
E	660
F	660
G	662
H	662
I	663
L	664
M	665
N	668
O	668
P	669
Q	671
R	671
S	673
T	677
U	683
V	684
W	684
X	685
Y	686

- A**
- AALias, `":ACquire:AALias"` on page 183
 - ACKnowledge, `":TRIGger:CAN:ACKnowledge"` on page 738
 - `":ACquire:AALias"` on page 183
 - `":ACquire:COMplete"` on page 184
 - `":ACquire:COUNt"` on page 185
 - `":ACquire:DAALias"` on page 186



- [":ACQUIRE:MODE"](#) on page 187
- [":ACQUIRE:POINTS"](#) on page 188
- [":ACQUIRE:RSIGNAL"](#) on page 189
- [":ACQUIRE:SEGMENTED:ANALYZE"](#) on page 190
- [":ACQUIRE:SEGMENTED:COUNT"](#) on page 191
- [":ACQUIRE:SEGMENTED:INDEX"](#) on page 192
- [":ACQUIRE:SRATE"](#) on page 195
- [":ACQUIRE:TYPE"](#) on page 196
- [":ACTIVITY"](#) on page 142
- ADDRESS, [":TRIGGER:IIC:PATTERN:ADDRESS"](#) on page 545
- [":AER \(Arm Event Register\)"](#) on page 143
- ALIGNment, [":TRIGGER:I2S:ALIGNMENT"](#) on page 528
- AMASK Commands:
 - [":MTEST:AMASK:CREATE"](#) on page 363
 - [":MTEST:AMASK:{SAVE | STORE}"](#) on page 727
 - [":MTEST:AMASK:SOURCE"](#) on page 364
 - [":MTEST:AMASK:UNITS"](#) on page 365
 - [":MTEST:AMASK:XDELTA"](#) on page 366
 - [":MTEST:AMASK:YDELTA"](#) on page 367
- ANALyze, [":ACQUIRE:SEGMENTED:ANALYZE"](#) on page 190
- APRInter, [":HARDcopy:APRInter"](#) on page 284
- AREA Commands:
 - [":HARDcopy:AREA"](#) on page 283
 - [":SAVE:IMAGe:AREA"](#) on page 407
- ASIZe, [":SBUS:IIC:ASIZE"](#) on page 433
- AUDio, [":TRIGGER:I2S:AUDIO"](#) on page 529
- [":AUToscale"](#) on page 144
 - [":AUToscale:AMODE"](#) on page 146
 - [":AUToscale:CHANNELS"](#) on page 147
- AUTosetup Commands:
 - [":TRIGGER:FLEXray:AUTosetup"](#) on page 506
 - [":TRIGGER:M1553:AUTosetup"](#) on page 567
- AVERAge Commands:
 - [":MTEST:AVERAGE"](#) on page 728
 - [":MTEST:AVERAGE:COUNT"](#) on page 729

- B**
- BASE Commands:
 - [":SBUS:M1553:BASE"](#) on page 435
 - [":SBUS:UART:BASE"](#) on page 439
 - [":TRIGger:UART:BASE"](#) on page 598
 - BAUDrate Commands:
 - [":TRIGger:CAN:SIGNal:BAUDrate"](#) on page 485
 - [":TRIGger:FLEXray:BAUDrate"](#) on page 507
 - [":TRIGger:LIN:SIGNal:BAUDrate"](#) on page 561
 - [":TRIGger:UART:BAUDrate"](#) on page 599
 - BIND, [":MTESt:SCALE:BIND"](#) on page 385
 - BIT<m>, [":BUS<n>:BIT<m>"](#) on page 200
 - BITorder Commands:
 - [":SBUS:SPI:BITorder"](#) on page 437
 - [":TRIGger:UART:BITorder"](#) on page 600
 - BITS, [":BUS<n>:BITS"](#) on page 201
 - [":BLANK"](#) on page 148
 - BURSt, [":TRIGger:UART:BURSt"](#) on page 601
 - [":BUS<n>:BIT<m>"](#) on page 200
 - [":BUS<n>:BITS"](#) on page 201
 - [":BUS<n>:CLEar"](#) on page 203
 - [":BUS<n>:DISPlay"](#) on page 204
 - [":BUS<n>:LABel"](#) on page 205
 - [":BUS<n>:MASK"](#) on page 206
 - BWLimit Commands:
 - [":CHANnel<n>:BWLimit"](#) on page 220
 - [":EXTernal:BWLimit"](#) on page 256
 - BYTeorder, [":WAVEform:BYTeorder"](#) on page 624
- C**
- [":CALibrate:DATE"](#) on page 209
 - [":CALibrate:LABel"](#) on page 210
 - [":CALibrate:OUTPut"](#) on page 211
 - [":CALibrate:START"](#) on page 212
 - [":CALibrate:STATus"](#) on page 213
 - [":CALibrate:SWITCh"](#) on page 214
 - [":CALibrate:TEMPerature"](#) on page 215
 - [":CALibrate:TIME"](#) on page 216

- CAN Commands:
 - [":SBUS:CAN:COUNt:ERRor"](#) on page 422
 - [":SBUS:CAN:COUNt:OVERload"](#) on page 423
 - [":SBUS:CAN:COUNt:RESet"](#) on page 424
 - [":SBUS:CAN:COUNt:TOTal"](#) on page 425
 - [":SBUS:CAN:COUNt:UTILization"](#) on page 426
 - [":TRIGger:CAN Commands"](#) on page 478
- CCBASe, [":TRIGger:FLEXray:FRAMe:CCBase"](#) on page 511
- CCRepetition, [":TRIGger:FLEXray:FRAMe:CCRepetition"](#) on page 512
- [":CDISplay"](#) on page 149
- CENTer, [":FUNCTion:CENTer"](#) on page 267
- CHANnel, [":TRIGger:FLEXray:CHANnel"](#) on page 508
- [":CHANnel:ACTivity"](#) on page 693
- [":CHANnel:LABel"](#) on page 694
- [":CHANnel:THReshold"](#) on page 695
- [":CHANnel2:SKEW"](#) on page 696
- [":CHANnel<n>:BWLimit"](#) on page 220
- [":CHANnel<n>:COUPling"](#) on page 221
- [":CHANnel<n>:DISPlay"](#) on page 222
- [":CHANnel<n>:IMPedance"](#) on page 223
- [":CHANnel<n>:INPut"](#) on page 697
- [":CHANnel<n>:INVert"](#) on page 224
- [":CHANnel<n>:LABel"](#) on page 225
- [":CHANnel<n>:OFFSet"](#) on page 226
- [":CHANnel<n>:PMODE"](#) on page 698
- [":CHANnel<n>:PROBe"](#) on page 227
- [":CHANnel<n>:PROBe:HEAD\[:TYPE\]"](#) on page 228
- [":CHANnel<n>:PROBe:ID"](#) on page 229
- [":CHANnel<n>:PROBe:SKEW"](#) on page 230
- [":CHANnel<n>:PROBe:STYPe"](#) on page 231
- [":CHANnel<n>:PROTection"](#) on page 232
- [":CHANnel<n>:RANGe"](#) on page 233
- [":CHANnel<n>:SCALe"](#) on page 234
- [":CHANnel<n>:UNITs"](#) on page 235
- [":CHANnel<n>:VERNier"](#) on page 236

- **CLear Commands:**
 - [":BUS<n>:CLear"](#) on page 203
 - [":DISPlay:CLear"](#) on page 246
 - [":MEASure:CLear"](#) on page 314
- **CLOCK Commands:**
 - [":TRIGger:IIC\[:SOURce\]:CLOCK"](#) on page 548
 - [":TRIGger:I2S:CLOCK:SLOPe"](#) on page 530
 - [":TRIGger:I2S:SOURce:CLOCK"](#) on page 537
 - [":TRIGger:SPI:CLOCK:SLOPe"](#) on page 582
 - [":TRIGger:SPI:CLOCK:TIMEout"](#) on page 583
 - [":TRIGger:SPI:SOURce:CLOCK"](#) on page 587
- ["*CLS \(Clear Status\)"](#) on page 117
- **COMplete**, [":ACQuire:COMplete"](#) on page 184
- **CONDition**, [":HWERegister:CONDition \(Hardware Event Condition Register\)"](#) on page 154
- **CONNect**, [":DISPlay:CONNect"](#) on page 699
- **COUNT Commands:**
 - [":ACQuire:COUNT"](#) on page 185
 - [":ACQuire:SEGmented:COUNT"](#) on page 191
 - [":MTESt:AVERage:COUNT"](#) on page 729
 - [":MTESt:COUNT:FWAVeforms"](#) on page 368
 - [":MTESt:COUNT:RESet"](#) on page 369
 - [":MTESt:COUNT:TIME"](#) on page 370
 - [":MTESt:COUNT:WAVeforms"](#) on page 371
 - [":SBUS:CAN:COUNT:ERRor"](#) on page 422
 - [":SBUS:CAN:COUNT:OVERload"](#) on page 423
 - [":SBUS:CAN:COUNT:RESet"](#) on page 424
 - [":SBUS:CAN:COUNT:TOTal"](#) on page 425
 - [":SBUS:CAN:COUNT:UTILization"](#) on page 426
 - [":SBUS:FLEXray:COUNT:NULL"](#) on page 428
 - [":SBUS:FLEXray:COUNT:RESet"](#) on page 429
 - [":SBUS:FLEXray:COUNT:SYNC"](#) on page 430
 - [":SBUS:FLEXray:COUNT:TOTal"](#) on page 431
 - [":SBUS:UART:COUNT:ERRor"](#) on page 440
 - [":SBUS:UART:COUNT:RESet"](#) on page 441

- [":SBUS:UART:COUNt:RXFRames"](#) on page 442
 - [":SBUS:UART:COUNt:TXFRames"](#) on page 443
 - [":TRIGger:EBURst:COUNt"](#) on page 496
 - [":TRIGger:SEQuence:COUNt"](#) on page 574
 - [":WAVeform:COUNt"](#) on page 625
 - [":WAVeform:SEGMENTed:COUNt"](#) on page 636
 - COUNter, [":MEASure:COUNter"](#) on page 315
 - COUPling Commands:
 - [":CHANnel<n>:COUPling"](#) on page 221
 - [":TRIGger\[:EDGE\]:COUPling"](#) on page 500
 - CREate, [":MTESt:AMASK:CREate"](#) on page 363
- D**
- DAALias, [":ACQuire:DAALias"](#) on page 186
 - DATA Commands:
 - [":DISPlay:DATA"](#) on page 247
 - [":LISTer:DATA"](#) on page 293
 - [":MTESt:DATA"](#) on page 372
 - [":TRIGger:CAN:PATtern:DATA"](#) on page 480
 - [":TRIGger:CAN:PATtern:DATA:LENGth"](#) on page 481
 - [":TRIGger:I2S:PATtern:DATA"](#) on page 531
 - [":TRIGger:I2S:SOURce:DATA"](#) on page 538
 - [":TRIGger:IIC:PATtern:DATA"](#) on page 546
 - [":TRIGger:IIC:PATtern:DATA2"](#) on page 547
 - [":TRIGger:IIC\[:SOURce\]:DATA"](#) on page 549
 - [":TRIGger:LIN:PATtern:DATA"](#) on page 556
 - [":TRIGger:LIN:PATtern:DATA:LENGth"](#) on page 558
 - [":TRIGger:M1553:PATtern:DATA"](#) on page 568
 - [":TRIGger:SPI:PATtern:DATA"](#) on page 585
 - [":TRIGger:SPI:SOURce:DATA"](#) on page 588
 - [":TRIGger:UART:DATA"](#) on page 602
 - [":WAVeform:DATA"](#) on page 626
 - DATE Commands:
 - [":CALibrate:DATE"](#) on page 209
 - [":SYSTem:DATE"](#) on page 446
 - DEFine, [":MEASure:DEFine"](#) on page 316
 - DEFinition Commands:

- [":TRIGger:CAN:SIGNal:DEFinition"](#) on page 739
- [":TRIGger:LIN:SIGNal:DEFinition"](#) on page 740
- DELay Commands:
 - [":MEASure:DELay"](#) on page 319
 - [":TIMEbase:DELay"](#) on page 737
- DELete, [":MTEST:DELete"](#) on page 373
- DESTination, [":HARDcopy:DESTination"](#) on page 706
- DEvice, [":HARDcopy:DEvice"](#) on page 707
- [":DIGital<n>:DISPlay"](#) on page 239
- [":DIGital<n>:LABel"](#) on page 240
- [":DIGital<n>:POSition"](#) on page 241
- [":DIGital<n>:SIZE"](#) on page 242
- [":DIGital<n>:THReshold"](#) on page 243
- [":DIGitize"](#) on page 150
- DISPlay Commands:
 - [":BUS<n>:DISPlay"](#) on page 204
 - [":CHANnel<n>:DISPlay"](#) on page 222
 - [":DIGital<n>:DISPlay"](#) on page 239
 - [":FUNction:DISPlay"](#) on page 268
 - [":LISTer:DISPlay"](#) on page 294
 - [":POD<n>:DISPlay"](#) on page 393
 - [":SBUS:DISPlay"](#) on page 427
- [":DISPlay:CLEar"](#) on page 246
- [":DISPlay:CONNect"](#) on page 699
- [":DISPlay:DATA"](#) on page 247
- [":DISPlay:LABel"](#) on page 249
- [":DISPlay:LABList"](#) on page 250
- [":DISPlay:ORDer"](#) on page 700
- [":DISPlay:PERsistence"](#) on page 251
- [":DISPlay:SOURce"](#) on page 252
- [":DISPlay:VECTors"](#) on page 253
- DMINus, [":TRIGger:USB:SOURce:DMINus"](#) on page 612
- DPLus, [":TRIGger:USB:SOURce:DPLus"](#) on page 613
- DSP, [":SYSTem:DSP"](#) on page 447
- DURation, [":TRIGger:DURation Commands"](#) on page 489

- DUTYcycle, ":MEASure:DUTYcycle" on page 321
- E**
 - EBURst, ":TRIGger:EBURst Commands" on page 495
 - EDGE Commands:
 - ":TRIGger[:EDGE] Commands" on page 499
 - ":TRIGger:SEQuence:EDGE" on page 575
 - ENABle":MTESt:ENABle" on page 374
 - ":ERASe" on page 701
 - ERRor Commands:
 - ":SBUS:CAN:COUNt:ERRor" on page 422
 - ":SBUS:UART:COUNt:ERRor" on page 440
 - ":SYSTem:ERRor" on page 448
 - ":TRIGger:FLEXray:ERRor:TYPE" on page 509
 - "*ESE (Standard Event Status Enable)" on page 118
 - "*ESR (Standard Event Status Register)" on page 120
 - EVENt Commands:
 - ":HWERegister[:EVENT] (Hardware Event Event Register)" on page 156
 - ":MTERegister[:EVENT] (Mask Test Event Event Register)" on page 161
 - ":TRIGger:FLEXray:EVENt:TYPE" on page 510
 - ":EXTErnal:BWLimit" on page 256
 - ":EXTErnal:IMPedance" on page 257
 - ":EXTErnal:INPut" on page 702
 - ":EXTErnal:PMODE" on page 703
 - ":EXTErnal:PROBe" on page 258
 - ":EXTErnal:PROBe:ID" on page 259
 - ":EXTErnal:PROBe:STYPE" on page 260
 - ":EXTErnal:PROTEction" on page 261
 - ":EXTErnal:RANGe" on page 262
 - ":EXTErnal:UNITs" on page 263
- F**
 - FACTion Commands:
 - ":MTESt:RMODE:FACTion:MEASure" on page 378
 - ":MTESt:RMODE:FACTion:PRINT" on page 379
 - ":MTESt:RMODE:FACTion:SAVE" on page 380
 - ":MTESt:RMODE:FACTion:STOP" on page 381
 - FACTors Commands:

- [":HARDcopy:FACTors"](#) on page 285
- [":SAVE:IMAGe:FACTors"](#) on page 408
- [FALLtime, ":MEASure:FALLtime"](#) on page 322
- [FFEed, ":HARDcopy:FFEed"](#) on page 286
- **FILEname Commands:**
 - [":HARDcopy:FILEname"](#) on page 708
 - [":RECall:FILEname"](#) on page 398
 - [":SAVE:FILEname"](#) on page 405
- [FIND, ":TRIGger:SEQuence:FIND"](#) on page 576
- **FLEXray Commands:**
 - [":SBUS:FLEXray:COUNt:NULL"](#) on page 428
 - [":SBUS:FLEXray:COUNt:RESet"](#) on page 429
 - [":SBUS:FLEXray:COUNt:SYNC"](#) on page 430
 - [":SBUS:FLEXray:COUNt:TOTal"](#) on page 431
 - [":TRIGger:FLEXray:AUTosetup"](#) on page 506
 - [":TRIGger:FLEXray:BAUDrate"](#) on page 507
 - [":TRIGger:FLEXray:CHANnel"](#) on page 508
 - [":TRIGger:FLEXray:ERRor:TYPE"](#) on page 509
 - [":TRIGger:FLEXray:EVENT:TYPE"](#) on page 510
 - [":TRIGger:FLEXray:FRAMe:CCBase"](#) on page 511
 - [":TRIGger:FLEXray:FRAMe:CCRepetition"](#) on page 512
 - [":TRIGger:FLEXray:FRAMe:ID"](#) on page 513
 - [":TRIGger:FLEXray:FRAMe:TYPE"](#) on page 514
 - [":TRIGger:FLEXray:SOURce"](#) on page 515
 - [":TRIGger:FLEXray:TRIGger"](#) on page 516
- **FORMat Commands:**
 - [":HARDcopy:FORMat"](#) on page 709
 - [":SAVE:IMAGe:FORMat"](#) on page 409
 - [":SAVE:WAVeform:FORMat"](#) on page 417
 - [":TRIGger:I2S:PATTern:FORMat"](#) on page 533
 - [":TRIGger:LIN:PATTern:FORMat"](#) on page 559
 - [":WAVeform:FORMat"](#) on page 628
- **FRAMe Commands:**
 - [":TRIGger:FLEXray:FRAMe:CCBase"](#) on page 511
 - [":TRIGger:FLEXray:FRAMe:CCRepetition"](#) on page 512

- [":TRIGger:FLEXray:FRAMe:ID"](#) on page 513
 - [":TRIGger:FLEXray:FRAMe:TYPE"](#) on page 514
 - [":TRIGger:SPI:SOURce:FRAMe"](#) on page 589
 - FRAMing Commands:
 - [":SBUS:UART:FRAMing"](#) on page 444
 - [":TRIGger:SPI:FRAMing"](#) on page 584
 - FREQuency, [":MEASure:FREQuency"](#) on page 323
 - [":FUNCTion:CENTer"](#) on page 267
 - [":FUNCTion:DISPlay"](#) on page 268
 - [":FUNCTion:GOFT:OPERation"](#) on page 269
 - [":FUNCTion:GOFT:SOURce1"](#) on page 270
 - [":FUNCTion:GOFT:SOURce2"](#) on page 271
 - [":FUNCTion:OFFSet"](#) on page 272
 - [":FUNCTion:OPERation"](#) on page 273
 - [":FUNCTion:RANGe"](#) on page 274
 - [":FUNCTion:REFerence"](#) on page 275
 - [":FUNCTion:SCALe"](#) on page 276
 - [":FUNCTion:SOURce"](#) on page 704
 - [":FUNCTion:SOURce1"](#) on page 277
 - [":FUNCTion:SOURce2"](#) on page 278
 - [":FUNCTion:SPAN"](#) on page 279
 - [":FUNCTion:VIEW"](#) on page 705
 - [":FUNCTion:WINDow"](#) on page 280
 - FWAVEforms, [":MTESt:COUNt:FWAVEforms"](#) on page 368
- G**
- GLITch (Pulse Width), [":TRIGger:GLITch Commands"](#) on page 517
 - GOFT Commands:
 - [":FUNCTion:GOFT:OPERation"](#) on page 269
 - [":FUNCTion:GOFT:SOURce1"](#) on page 270
 - [":FUNCTion:GOFT:SOURce2"](#) on page 271
 - GRAYscale, [":HARDcopy:GRAYscale"](#) on page 710
 - GREaterthan Commands:
 - [":TRIGger:DURation:GREaterthan"](#) on page 490
 - [":TRIGger:GLITch:GREaterthan"](#) on page 519
- H**
- [":HARDcopy:AREA"](#) on page 283

- [":HARDcopy:APRinter"](#) on page 284
 - [":HARDcopy:DESTination"](#) on page 706
 - [":HARDcopy:DEVIce"](#) on page 707
 - [":HARDcopy:FACTors"](#) on page 285
 - [":HARDcopy:FFEed"](#) on page 286
 - [":HARDcopy:FILEname"](#) on page 708
 - [":HARDcopy:FORMat"](#) on page 709
 - [":HARDcopy:GRAYscale"](#) on page 710
 - [":HARDcopy:IGColors"](#) on page 711
 - [":HARDcopy:INKSaver"](#) on page 287
 - [":HARDcopy:LAYout"](#) on page 288
 - [":HARDcopy:PALette"](#) on page 289
 - [":HARDcopy:PDRiver"](#) on page 712
 - [":HARDcopy:PRINter:LIST"](#) on page 290
 - [":HARDcopy:STARt"](#) on page 291
 - [HEAD, ":CHANnel<n>:PROBe:HEAD\[:TYPE\]"](#) on page 228
 - [HFReject, ":TRIGger:HFReject"](#) on page 471
 - [HOLDoff, ":TRIGger:HOLDoff"](#) on page 472
 - [":HWEenable \(Hardware Event Enable Register\)"](#) on page 152
 - [":HWERegister:CONDition \(Hardware Event Condition Register\)"](#) on page 154
 - [":HWERegister\[:EVENT\] \(Hardware Event Event Register\)"](#) on page 156
- I**
- ID Commands:
 - [":TRIGger:CAN:PATtern:ID"](#) on page 482
 - [":TRIGger:CAN:PATtern:ID:MODE"](#) on page 483
 - [":TRIGger:FLEXray:FRAMe:ID"](#) on page 513
 - IDLE Commands:
 - [":TRIGger:EBURst:IDLE"](#) on page 497
 - [":TRIGger:UART:IDLE"](#) on page 603
 - ["*IDN \(Identification Number\)"](#) on page 122
 - I2S Commands:
 - [":SBUS:I2S:BASE"](#) on page 432
 - [":TRIGger:I2S Commands"](#) on page 526
 - IIC Commands:
 - [":SBUS:IIC:ASIZE"](#) on page 433

- [":TRIGger:IIC Commands"](#) on page 544
- IGCOLORS Commands:
 - [":HARDcopy:IGColors"](#) on page 711
 - [":SAVE:IMAGe:INKSaver"](#) on page 410
- IMAGE Commands:
 - [":RECall:IMAGe\[:START\]"](#) on page 399
 - [":SAVE:IMAGe:AREA"](#) on page 407
 - [":SAVE:IMAGe:FACTors"](#) on page 408
 - [":SAVE:IMAGe:FORMat"](#) on page 409
 - [":SAVE:IMAGe:INKSaver"](#) on page 410
 - [":SAVE:IMAGe:PALette"](#) on page 411
 - [":SAVE:IMAGe\[:START\]"](#) on page 406
- IMPedance Commands:
 - [":CHANnel<n>:IMPedance"](#) on page 223
 - [":EXTernal:IMPedance"](#) on page 257
- INCRement, [":MEASure:STATistics:INCRement"](#) on page 340
- INDEx, [":ACQuire:SEGmented:INDEx"](#) on page 192
- INKSaver, [":HARDcopy:INKSaver"](#) on page 287
- INVert, [":CHANnel<n>:INVert"](#) on page 224
- L**
 - LABEL Commands:
 - [":BUS<n>:LABel"](#) on page 205
 - [":CALibrate:LABel"](#) on page 210
 - [":CHANnel:LABel"](#) on page 694
 - [":CHANnel<n>:LABel"](#) on page 225
 - [":DIGital<n>:LABel"](#) on page 240
 - [":DISPlay:LABel"](#) on page 249
 - LABList, [":DISPlay:LABList"](#) on page 250
 - LAYout, [":HARDcopy:LAYout"](#) on page 288
 - LENGth Commands:
 - [":SAVE:WAVEform:LENGth"](#) on page 418
 - [":TRIGger:CAN:PATtern:DATA:LENGth"](#) on page 481
 - [":TRIGger:LIN:PATtern:DATA:LENGth"](#) on page 558
 - LESSthan Commands:
 - [":TRIGger:DURation:LESSthan"](#) on page 491
 - [":TRIGger:GLITCh:LESSthan"](#) on page 520

- LEVel Commands:
 - [":TRIGger\[:EDGE\]:LEVel"](#) on page 501
 - [":TRIGger:GLITCh:LEVel"](#) on page 521
 - LIN Commands:
 - [":SBUS:LIN:PARity"](#) on page 434
 - [":TRIGger:LIN Commands"](#) on page 553
 - LINE, [":TRIGger:TV:LINE"](#) on page 591
 - LIST, [":HARDcopy:PRINter:LIST"](#) on page 290
 - LISTer Commands:
 - [":LISTer:DATA"](#) on page 293
 - [":LISTer:DISPlay"](#) on page 294
 - [":SAVE:LISTer\[:STARt\]"](#) on page 412
 - LOAD, [":MTEST:LOAD"](#) on page 730
 - LOCK Commands:
 - [":MTEST:LOCK"](#) on page 375
 - [":SYSTEM:LOCK"](#) on page 449
 - [":SYSTEM:PROTection:LOCK"](#) on page 451
 - LOWer Commands:
 - [":MEASure:LOWer"](#) on page 713
 - [":TRIGger:M1553:SOURce:LOWer"](#) on page 570
 - ["*LRN \(Learn Device Setup\)"](#) on page 123
- M**
- M1553 Commands:
 - [":SBUS:M1553:BASE"](#) on page 435
 - [":TRIGger:M1553 Commands"](#) on page 566
 - [":MARKer:MODE"](#) on page 297
 - [":MARKer:X1Position"](#) on page 298
 - [":MARKer:X1Y1source"](#) on page 299
 - [":MARKer:X2Position"](#) on page 300
 - [":MARKer:X2Y2source"](#) on page 301
 - [":MARKer:XDELta"](#) on page 302
 - [":MARKer:Y1Position"](#) on page 303
 - [":MARKer:Y2Position"](#) on page 304
 - [":MARKer:YDELta"](#) on page 305
 - MASK Commands:
 - [":BUS<n>:MASK"](#) on page 206

- [":RECall:MASK\[:STArT\]"](#) on page 400
- [":SAVE:MASK\[:STArT\]"](#) on page 413
- [":MEASure:CLEAr"](#) on page 314
- [":MEASure:COUNter"](#) on page 315
- [":MEASure:DEFine"](#) on page 316
- [":MEASure:DELay"](#) on page 319
- [":MEASure:DUTYcycle"](#) on page 321
- [":MEASure:FALLtime"](#) on page 322
- [":MEASure:FREQuency"](#) on page 323
- [":MEASure:LOWer"](#) on page 713
- [":MEASure:NWIDth"](#) on page 324
- [":MEASure:OVERshoot"](#) on page 325
- [":MEASure:PERiod"](#) on page 327
- [":MEASure:PHASe"](#) on page 328
- [":MEASure:PREShoot"](#) on page 329
- [":MEASure:PWIDth"](#) on page 330
- [":MEASure:RESults"](#) on page 331
- [":MEASure:RISetime"](#) on page 334
- [":MEASure:SCRatch"](#) on page 714
- [":MEASure:SDEVIation"](#) on page 335
- [":MEASure:SHOW"](#) on page 336
- [":MEASure:SOURce"](#) on page 337
- [":MEASure:STATistics"](#) on page 339
- [":MEASure:STATistics:INCRement"](#) on page 340
- [":MEASure:STATistics:RESet"](#) on page 341
- [":MEASure:TDELta"](#) on page 715
- [":MEASure:TEDGe"](#) on page 342
- [":MEASure:THResholds"](#) on page 716
- [":MEASure:TMAX"](#) on page 717
- [":MEASure:TMIN"](#) on page 718
- [":MEASure:TSTArT"](#) on page 719
- [":MEASure:TSTOP"](#) on page 720
- [":MEASure:TVALue"](#) on page 344
- [":MEASure:TVOLt"](#) on page 721
- [":MEASure:UPPer"](#) on page 723

- [":MEASure:VAMplitude"](#) on page 346
- [":MEASure:VAverage"](#) on page 347
- [":MEASure:VBASe"](#) on page 348
- [":MEASure:VDELta"](#) on page 724
- [":MEASure:VMAX"](#) on page 349
- [":MEASure:VMIN"](#) on page 350
- [":MEASure:VPP"](#) on page 351
- [":MEASure:VRATio"](#) on page 352
- [":MEASure:VRMS"](#) on page 353
- [":MEASure:VSTArt"](#) on page 725
- [":MEASure:VSTOp"](#) on page 726
- [":MEASure:VTIME"](#) on page 354
- [":MEASure:VTOp"](#) on page 355
- [":MEASure:XMAX"](#) on page 356
- [":MEASure:XMIN"](#) on page 357
- [MEASure, ":MTESt:RMODe:FACTion:MEASure"](#) on page 378
- [":MERGe"](#) on page 158
- MODE Commands:
 - [":ACQuire:MODE"](#) on page 187
 - [":MARKer:MODE"](#) on page 297
 - [":SBUS:MODE"](#) on page 436
 - [":TIMebase:MODE"](#) on page 457
 - [":TRIGger:CAN:PATtern:ID:MODE"](#) on page 483
 - [":TRIGger:MODE"](#) on page 473
 - [":TRIGger:TV:MODE"](#) on page 592
 - [":WAVeform:POINts:MODE"](#) on page 631
- [":MTEenable \(Mask Test Event Enable Register\)"](#) on page 159
- [":MTERegister\[:EVENT\] \(Mask Test Event Event Register\)"](#) on page 161
- [":MTESt:AMASk:CREate"](#) on page 363
- [":MTESt:AMASk:{SAVE | STORE}"](#) on page 727
- [":MTESt:AMASk:SOURce"](#) on page 364
- [":MTESt:AMASk:UNITs"](#) on page 365
- [":MTESt:AMASk:XDELta"](#) on page 366
- [":MTESt:AMASk:YDELta"](#) on page 367
- [":MTESt:AVERage"](#) on page 728

- ":MTESt:AVERage:COUNT" on page 729
 - ":MTESt:COUNT:FWAVeforms" on page 368
 - ":MTESt:COUNT:RESet" on page 369
 - ":MTESt:COUNT:TIME" on page 370
 - ":MTESt:COUNT:WAVeforms" on page 371
 - ":MTESt:DATA" on page 372
 - ":MTESt:DELeTe" on page 373
 - ":MTESt:ENABle" on page 374
 - ":MTESt:LOAD" on page 730
 - ":MTESt:LOCK" on page 375
 - ":MTESt:OUTPut" on page 376
 - ":MTESt:RMODE" on page 377
 - ":MTESt:RMODE:FACTION:MEASure" on page 378
 - ":MTESt:RMODE:FACTION:PRINt" on page 379
 - ":MTESt:RMODE:FACTION:SAVE" on page 380
 - ":MTESt:RMODE:FACTION:STOP" on page 381
 - ":MTESt:RMODE:SIGMa" on page 382
 - ":MTESt:RMODE:TIME" on page 383
 - ":MTESt:RMODE:WAVeforms" on page 384
 - ":MTESt:RUMode" on page 731
 - ":MTESt:RUMode:SOFailure" on page 732
 - ":MTESt:SCALE:BIND" on page 385
 - ":MTESt:SCALE:X1" on page 386
 - ":MTESt:SCALE:XDELta" on page 387
 - ":MTESt:SCALE:Y1" on page 388
 - ":MTESt:SCALE:Y2" on page 389
 - ":MTESt:SOURce" on page 390
 - ":MTESt:{START | STOP}" on page 733
 - ":MTESt:TITLe" on page 391
 - ":MTESt:TRIGger:SOURce" on page 734
- N**
- NREJect, ":TRIGger:NREJect" on page 474
 - NULL, ":SBUS:FLEXray:COUNT:NULL" on page 428
 - NWIDth, ":MEASure:NWIDth" on page 324
- O**
- OFFSet Commands:

- ":CHANnel<n>:OFFSet" on page 226
 - ":FUNction:OFFSet" on page 272
 - "*OPC (Operation Complete)" on page 124
 - ":OPEE (Operation Status Enable Register)" on page 163
 - OPERation Commands:
 - ":FUNction:GOFT:OPERation" on page 269
 - ":FUNction:OPERation" on page 273
 - ":OPERegister:CONDition (Operation Status Condition Register)" on page 165
 - ":OPERegister[:EVENT] (Operation Status Event Register)" on page 167
 - "*OPT (Option Identification)" on page 125
 - ORDER, ":DISPlay:ORDer" on page 700
 - OUTPut Commands:
 - ":CALibrate:OUTPut" on page 211
 - ":MTESt:OUTPut" on page 376
 - OVERload, ":SBUS:CAN:COUNT:OVERload" on page 423
 - OVERshoot, ":MEASure:OVERshoot" on page 325
 - ":OVLenable (Overload Event Enable Register)" on page 169
 - ":OVLRegister (Overload Event Register)" on page 171
- P**
- PALette Commands:
 - ":HARDcopy:PALette" on page 289
 - ":SAVE:IMAGe:PALette" on page 411
 - PARity Commands:
 - ":SBUS:LIN:PARity" on page 434
 - ":TRIGger:UART:PARity" on page 604
 - PATTern Commands:
 - ":TRIGger:CAN:PATTern:DATA" on page 480
 - ":TRIGger:CAN:PATTern:DATA:LENGth" on page 481
 - ":TRIGger:CAN:PATTern:ID" on page 482
 - ":TRIGger:CAN:PATTern:ID:MODE" on page 483
 - ":TRIGger:DURation:PATTern" on page 492
 - ":TRIGger:I2S:PATTern:DATA" on page 531
 - ":TRIGger:I2S:PATTern:FORMat" on page 533
 - ":TRIGger:IIC:PATTern:ADDRes" on page 545
 - ":TRIGger:IIC:PATTern:DATA" on page 546

- [":TRIGger:IIC:PATtern:DATA2"](#) on page 547
- [":TRIGger:LIN:PATtern:DATA"](#) on page 556
- [":TRIGger:LIN:PATtern:DATA:LENGth"](#) on page 558
- [":TRIGger:LIN:PATtern:FORMat"](#) on page 559
- [":TRIGger:M1553:PATtern:DATA"](#) on page 568
- [":TRIGger:PATtern"](#) on page 475
- [":TRIGger:SEQuence:PATtern"](#) on page 577
- [":TRIGger:SPI:PATtern:DATA"](#) on page 585
- [":TRIGger:SPI:PATtern:WIDTh"](#) on page 586
- PDRiver, [":HARDcopy:PDRiver"](#) on page 712
- PERiod, [":MEASure:PERiod"](#) on page 327
- PERSistence, [":DISPlay:PERsistence"](#) on page 251
- PHASe, [":MEASure:PHASe"](#) on page 328
- PMODE, [":CHANnel<n>:PMODE"](#) on page 698
- [":POD<n>:DISPlay"](#) on page 393
- [":POD<n>:SIZE"](#) on page 394
- [":POD<n>:THReshold"](#) on page 395
- POINTs Commands:
 - [":ACQuire:POINTs"](#) on page 188
 - [":WAVeform:POINTs"](#) on page 629
 - [":WAVeform:POINTs:MODE"](#) on page 631
- POLarity Commands:
 - [":TRIGger:GLITCh:POLarity"](#) on page 522
 - [":TRIGger:TV:POLarity"](#) on page 593
 - [":TRIGger:UART:POLarity"](#) on page 605
- POSition Commands:
 - [":DIGital<n>:POSition"](#) on page 241
 - [":TIMebase:POSition"](#) on page 458
 - [":TIMebase:WINDow:POSition"](#) on page 464
- PREamble, [":WAVeform:PREamble"](#) on page 633
- PRECision, [":SYSTem:PRECision"](#) on page 450
- PREShoot, [":MEASure:PREShoot"](#) on page 329
- PRINt, [":MTEST:RMODE:FACTion:PRINt"](#) on page 379
- [":PRINt"](#) on page 173
- [":PRINt?"](#) on page 735

- PRINter, ":HARDcopy:PRINter:LIST" on page 290
- PROBe Commands:
 - ":CHANnel<n>:PROBe" on page 227
 - ":CHANnel<n>:PROBe:HEAD[:TYPE]" on page 228
 - ":CHANnel<n>:PROBe:ID" on page 229
 - ":CHANnel<n>:PROBe:SKEW" on page 230
 - ":CHANnel<n>:PROBe:STYPe" on page 231
 - ":EXTeRnal:PROBe" on page 258
- PROTection Commands:
 - ":CHANnel<n>:PROTection" on page 232
 - ":EXTeRnal:PROTection" on page 261
 - ":SYSTem:PROTection:LOCK" on page 451
- Pulse Width (GLITCh), ":TRIGger:GLITCh Commands" on page 517
- PWD Commands:
 - ":RECall:PWD" on page 401
 - ":SAVE:PWD" on page 414
- PWIDth, ":MEASure:PWIDth" on page 330
- Q**
 - QUALifier Commands:
 - ":TRIGger:DURation:QUALifier" on page 493
 - ":TRIGger:GLITCh:QUALifier" on page 523
 - ":TRIGger:IIC:TRIGger:QUALifier" on page 550
 - ":TRIGger:UART:QUALifier" on page 606
- R**
 - RANGe Commands:
 - ":CHANnel<n>:RANGe" on page 233
 - ":EXTeRnal:RANGe" on page 262
 - ":FUNCTion:RANGe" on page 274
 - ":TIMebase:RANGe" on page 459
 - ":TIMebase:WINDow:RANGe" on page 465
 - ":TRIGger:DURation:RANGe" on page 494
 - ":TRIGger:GLITCh:RANGe" on page 524
 - ":TRIGger:I2S:RANGe" on page 534
 - "*RCL (Recall)" on page 127
 - ":RECall:FILEname" on page 398
 - ":RECall:IMAGe[:STARt]" on page 399

- ":RECall:MASK[:START]" on page 400
- ":RECall:PWD" on page 401
- ":RECall:SETup[:START]" on page 402
- REFClOCK, ":TIMEbase:REFClOCK" on page 460
- REFerence Commands:
 - ":FUNction:REFerence" on page 275
 - ":TIMEbase:REFerence" on page 461
- REJect, ":TRIGger[:EDGE]:REJect" on page 502
- RESet Commands:
 - ":MEASure:STATistics:RESet" on page 341
 - ":MTESt:COUNt:RESet" on page 369
 - ":SBUS:CAN:COUNt:RESet" on page 424
 - ":SBUS:FLEXray:COUNt:RESet" on page 429
 - ":SBUS:UART:COUNt:RESet" on page 441
 - ":TRIGger:SEQuence:RESet" on page 578
- RESults, ":MEASure:RESults" on page 331
- RISetime, ":MEASure:RISetime" on page 334
- RMODe Commands:
 - ":MTESt:RMODe" on page 377
 - ":MTESt:RMODe:FACTION:MEASure" on page 378
 - ":MTESt:RMODe:FACTION:PRINT" on page 379
 - ":MTESt:RMODe:FACTION:SAVE" on page 380
 - ":MTESt:RMODe:FACTION:STOP" on page 381
 - ":MTESt:RMODe:SIGMa" on page 382
 - ":MTESt:RMODe:TIME" on page 383
 - ":MTESt:RMODe:WAVEforms" on page 384
- "Root (:)" Commands" on page 139
- RSIGnal, ":ACQuire:RSIGnal" on page 189
- "*RST (Reset)" on page 128
- RTA, ":TRIGger:M1553:RTA" on page 569
- RUMode Commands:
 - ":MTESt:RUMode" on page 731
 - ":MTESt:RUMode:SOFailure" on page 732
- ":RUN" on page 174
- RWIDth, ":TRIGger:I2S:RWIDth" on page 536

- RX, ":TRIGger:UART:SOURce:RX" on page 607
- RXFRames, ":SBUS:UART:COUNt:RXFRames" on page 442
- S**
 - SAMPlEpoint Commands:
 - ":TRIGger:CAN:SAMPlEpoint" on page 484
 - ":TRIGger:LIN:SAMPlEpoint" on page 560
 - "*SAV (Save)" on page 131
 - SAVE Commands:
 - ":MTESt:AMASk:{SAVE | STORe}" on page 727
 - ":MTESt:RMODE:FACTion:SAVE" on page 380
 - ":SAVE:FILEname" on page 405
 - ":SAVE:IMAGe:AREA" on page 407
 - ":SAVE:IMAGe:FACTors" on page 408
 - ":SAVE:IMAGe:FORMat" on page 409
 - ":SAVE:IMAGe:INKSaver" on page 410
 - ":SAVE:IMAGe:PALette" on page 411
 - ":SAVE:IMAGe[:START]" on page 406
 - ":SAVE:LISTer[:START]" on page 412
 - ":SAVE:MASK[:START]" on page 413
 - ":SAVE:PWD" on page 414
 - ":SAVE:SETup[:START]" on page 415
 - ":SAVE:WAVEform:FORMat" on page 417
 - ":SAVE:WAVEform:LENGth" on page 418
 - ":SAVE:WAVEform:SEGmented" on page 419
 - ":SAVE:WAVEform[:START]" on page 416
 - ":SBUS:CAN:COUNt:ERRor" on page 422
 - ":SBUS:CAN:COUNt:OVERload" on page 423
 - ":SBUS:CAN:COUNt:RESet" on page 424
 - ":SBUS:CAN:COUNt:TOTal" on page 425
 - ":SBUS:CAN:COUNt:UTILization" on page 426
 - ":SBUS:DISPlay" on page 427
 - ":SBUS:FLEXray:COUNt:NULL" on page 428
 - ":SBUS:FLEXray:COUNt:RESet" on page 429
 - ":SBUS:FLEXray:COUNt:SYNC" on page 430
 - ":SBUS:FLEXray:COUNt:TOTal" on page 431
 - ":SBUS:I2S:BASE" on page 432

- [":SBUS:IIC:ASize"](#) on page 433
- [":SBUS:LIN:PARity"](#) on page 434
- [":SBUS:M1553:BASE"](#) on page 435
- [":SBUS:MODE"](#) on page 436
- [":SBUS:SPI:BITorder"](#) on page 437
- [":SBUS:SPI:WIDTh"](#) on page 438
- [":SBUS:UART:BASE"](#) on page 439
- [":SBUS:UART:COUNt:ERRor"](#) on page 440
- [":SBUS:UART:COUNt:RESet"](#) on page 441
- [":SBUS:UART:COUNt:RXFRames"](#) on page 442
- [":SBUS:UART:COUNt:TXFRames"](#) on page 443
- [":SBUS:UART:FRAMing"](#) on page 444
- SCALe Commands:
 - [":CHANnel<n>:SCALe"](#) on page 234
 - [":FUNction:SCALe"](#) on page 276
 - [":MTESt:SCALe:BINd"](#) on page 385
 - [":MTESt:SCALe:X1"](#) on page 386
 - [":MTESt:SCALe:XDELta"](#) on page 387
 - [":MTESt:SCALe:Y1"](#) on page 388
 - [":MTESt:SCALe:Y2"](#) on page 389
 - [":TIMEbase:SCALe"](#) on page 462
 - [":TIMEbase:WINDow:SCALe"](#) on page 466
- SCRatch, [":MEASure:SCRatch"](#) on page 714
- SDEViation, [":MEASure:SDEViation"](#) on page 335
- [":SERial"](#) on page 175
- SEGmented Commands:
 - [":ACQuire:SEGmented:ANALyze"](#) on page 190
 - [":ACQuire:SEGmented:COUNt"](#) on page 191
 - [":ACQuire:SEGmented:INDex"](#) on page 192
 - [":SAVE:WAVEform:SEGmented"](#) on page 419
 - [":WAVEform:SEGmented:COUNt"](#) on page 636
 - [":WAVEform:SEGmented:TTAG"](#) on page 637
- SETup Commands:
 - [":RECall:SETup\[:STARt\]"](#) on page 402
 - [":SAVE:SETup\[:STARt\]"](#) on page 415

- `":SYSTEM:SETup"` on page 452
- SEQUENCE, `":TRIGger:SEQuence Commands"` on page 573
- SHOW, `":MEASure:SHOW"` on page 336
- SIGMa, `":MTESt:RMODE:SIGMa"` on page 382
- SIGNAL Commands:
 - `":TRIGger:CAN:SIGNal:BAUDrate"` on page 485
 - `":TRIGger:CAN:SIGNal:DEFinition"` on page 739
 - `":TRIGger:LIN:SIGNal:BAUDrate"` on page 561
 - `":TRIGger:LIN:SIGNal:DEFinition"` on page 740
- `":SINGle"` on page 176
- SIZE Commands:
 - `":DIGital<n>:SIZE"` on page 242
 - `":POD<n>:SIZE"` on page 394
- SKEW, `":CHANnel<n>:PROBe:SKEW"` on page 230
- SLOPe Commands:
 - `":TRIGger:EBURst:SLOPe"` on page 498
 - `":TRIGger[:EDGE]:SLOPe"` on page 503
 - `":TRIGger:I2S:CLOCK:SLOPe"` on page 530
 - `":TRIGger:SPI:CLOCK:SLOPe"` on page 582
- SOFailure, `":MTESt:RUMode:SOFailure"` on page 732
- SOURce Commands:
 - `":DISPlay:SOURce"` on page 252
 - `":FUNction:SOURce"` on page 704
 - `":MEASure:SOURce"` on page 337
 - `":MTESt:AMASk:SOURce"` on page 364
 - `":MTESt:SOURce"` on page 390
 - `":MTESt:TRIGger:SOURce"` on page 734
 - `":TRIGger:CAN:SOURce"` on page 486
 - `":TRIGger:FLEXray:SOURce"` on page 515
 - `":TRIGger:GLITch:SOURce"` on page 525
 - `":TRIGger:I2S:SOURce:CLOCK"` on page 537
 - `":TRIGger:I2S:SOURce:DATA"` on page 538
 - `":TRIGger:I2S:SOURce:WSElect"` on page 539
 - `":TRIGger:IIC[:SOURce]:CLOCK"` on page 548
 - `":TRIGger:IIC[:SOURce]:DATA"` on page 549

- [":TRIGger:LIN:SOURce"](#) on page 562
- [":TRIGger:M1553:SOURce:LOWer"](#) on page 570
- [":TRIGger:M1553:SOURce:UPPer"](#) on page 571
- [":TRIGger:SPI:SOURce:CLOCK"](#) on page 587
- [":TRIGger:SPI:SOURce:DATA"](#) on page 588
- [":TRIGger:SPI:SOURce:FRAMe"](#) on page 589
- [":TRIGger:TV:SOURce"](#) on page 594
- [":TRIGger:UART:SOURce:RX"](#) on page 607
- [":TRIGger:UART:SOURce:TX"](#) on page 608
- [":TRIGger:USB:SOURce:DMINus"](#) on page 612
- [":TRIGger:USB:SOURce:DPLus"](#) on page 613
- [":WAVeform:SOURce"](#) on page 638
- [":WAVeform:SOURce:SUBSource"](#) on page 642
- **SOURce1 Commands:**
 - [":FUNCTion:GOFT:SOURce1"](#) on page 270
 - [":FUNCTion:SOURce1"](#) on page 277
- **SOURce2 Commands:**
 - [":FUNCTion:GOFT:SOURce2"](#) on page 271
 - [":FUNCTion:SOURce2"](#) on page 278
- **SPAN**, [":FUNCTion:SPAN"](#) on page 279
- **SPEEd**, [":TRIGger:USB:SPEEd"](#) on page 614
- **SPI Commands:**
 - [":SBUS:SPI:BITOrder"](#) on page 437
 - [":SBUS:SPI:WIDTh"](#) on page 438
 - [":TRIGger:SPI Commands"](#) on page 581
- **SRATe**, [":ACQuire:SRATe"](#) on page 195
- **"*SRE (Service Request Enable)"** on page 132
- **STANdard Commands:**
 - [":TRIGger:LIN:STANdard"](#) on page 563
 - [":TRIGger:TV:STANdard"](#) on page 595
- **STARt Commands:**
 - [":CALibrate:STARt"](#) on page 212
 - [":HARDcopy:STARt"](#) on page 291
 - [":MTESt:{STARt | STOP}"](#) on page 733
 - [":RECall:IMAGe\[:STARt\]"](#) on page 399

- ":RECall:MASK[:START]" on page 400
- ":RECall:SETup[:START]" on page 402
- ":SAVE:IMAGe[:START]" on page 406
- ":SAVE:LISTer[:START]" on page 412
- ":SAVE:MASK[:START]" on page 413
- ":SAVE:SETup[:START]" on page 415
- ":SAVE:WAVeform[:START]" on page 416
- STATistics Commands:
 - ":MEASure:STATistics" on page 339
 - ":MEASure:STATistics:INCRement" on page 340
 - ":MEASure:STATistics:RESet" on page 341
- STATus Commands:
 - ":CALibrate:STATus" on page 213
 - ":STATus" on page 177
- "*STB (Read Status Byte)" on page 134
- STOP Commands:
 - ":MTESt:RMODe:FACTION:STOP" on page 381
 - ":MTESt:{START | STOP}" on page 733
- ":STOP" on page 178
- STORe, ":MTESt:AMASK:{SAVE | STORe}" on page 727
- SUBSource, ":WAVeform:SOURce:SUBSource" on page 642
- SWEEp, ":TRIGger:SWEEp" on page 477
- SWITCh, ":CALibrate:SWITCh" on page 214
- SYNC, ":SBUS:FLEXray:COUNt:SYNC" on page 430
- SYNCbreak, ":TRIGger:LIN:SYNCbreak" on page 564
- ":SYSTem:DATE" on page 446
- ":SYSTem:DSP" on page 447
- ":SYSTem:ERRor" on page 448
- ":SYSTem:LOCK" on page 449
- ":SYSTem:PRECision" on page 450
- ":SYSTem:SETup" on page 452
- ":SYSTem:TIME" on page 454
- T** • TDELta, ":MEASure:TDELta" on page 715
- TEDGe, ":MEASure:TEDGe" on page 342
- TEMPerature, ":CALibrate:TEMPerature" on page 215

- `":TER (Trigger Event Register)"` on page 179
- THReshold Commands:
 - `":CHANnel:THReshold"` on page 695
 - `":DIGital<n>:THReshold"` on page 243
 - `":MEASure:THResholds"` on page 716
 - `":POD<n>:THReshold"` on page 395
 - `":TRIGger:THReshold"` on page 741
- THResholds, `":MEASure:THResholds"` on page 716
- TIME Commands:
 - `":CALibrate:TIME"` on page 216
 - `":MTESt:COUNt:TIME"` on page 370
 - `":MTESt:RMODE:TIME"` on page 383
 - `":SYSTem:TIME"` on page 454
- `":TIMEbase:DELay"` on page 737
- `":TIMEbase:MODE"` on page 457
- `":TIMEbase:POSition"` on page 458
- `":TIMEbase:RANGe"` on page 459
- `":TIMEbase:REFClock"` on page 460
- `":TIMEbase:REFerence"` on page 461
- `":TIMEbase:SCALE"` on page 462
- `":TIMEbase:VERNier"` on page 463
- `":TIMEbase:WINDow:POSition"` on page 464
- `":TIMEbase:WINDow:RANGe"` on page 465
- `":TIMEbase:WINDow:SCALE"` on page 466
- TIMEout, `":TRIGger:SPI:CLOCK:TIMEout"` on page 583
- TIMer, `":TRIGger:SEQUence:TIMer"` on page 579
- TITLe, `":MTESt:TITLe"` on page 391
- TMAX, `":MEASure:TMAX"` on page 717
- TMIN, `":MEASure:TMIN"` on page 718
- TOTal Commands:
 - `":SBUS:CAN:COUNt:TOTal"` on page 425
 - `":SBUS:FLEXray:COUNt:TOTal"` on page 431
- `"*TRG (Trigger)"` on page 136
- TRIGger Commands:
 - `":MTESt:TRIGger:SOURce"` on page 734

- ":TRIGger:CAN:TRIGger" on page 487
- ":TRIGger:FLEXray:TRIGger" on page 516
- ":TRIGger:I2S:TRIGger" on page 540
- ":TRIGger:IIC:TRIGger:QUALifier" on page 550
- ":TRIGger:IIC:TRIGger[:TYPE]" on page 551
- ":TRIGger:LIN:TRIGger" on page 565
- ":TRIGger:SEQuence:TRIGger" on page 580
- ":TRIGger:USB:TRIGger" on page 615
- ":TRIGger:HFReject" on page 471
- ":TRIGger:HOLDoff" on page 472
- ":TRIGger:MODE" on page 473
- ":TRIGger:NREJect" on page 474
- ":TRIGger:PATtern" on page 475
- ":TRIGger:SWEep" on page 477
- ":TRIGger:THReshold" on page 741
- ":TRIGger:CAN:ACKnowledge" on page 738
- ":TRIGger:CAN:PATtern:DATA" on page 480
- ":TRIGger:CAN:PATtern:DATA:LENGth" on page 481
- ":TRIGger:CAN:PATtern:ID" on page 482
- ":TRIGger:CAN:PATtern:ID:MODE" on page 483
- ":TRIGger:CAN:SAMPlepoint" on page 484
- ":TRIGger:CAN:SIGNal:BAUDrate" on page 485
- ":TRIGger:CAN:SIGNal:DEFinition" on page 739
- ":TRIGger:CAN:SOURce" on page 486
- ":TRIGger:CAN:TRIGger" on page 487
- ":TRIGger:DURation:GREaterthan" on page 490
- ":TRIGger:DURation:LESSthan" on page 491
- ":TRIGger:DURation:PATtern" on page 492
- ":TRIGger:DURation:QUALifier" on page 493
- ":TRIGger:DURation:RANGe" on page 494
- ":TRIGger[:EDGE]:COUPling" on page 500
- ":TRIGger[:EDGE]:LEVel" on page 501
- ":TRIGger[:EDGE]:REJect" on page 502
- ":TRIGger[:EDGE]:SLOPe" on page 503
- ":TRIGger[:EDGE]:SOURce" on page 504

- [":TRIGger:FLEXray:AUTosetup"](#) on page 506
- [":TRIGger:FLEXray:BAUDrate"](#) on page 507
- [":TRIGger:FLEXray:CHANnel"](#) on page 508
- [":TRIGger:FLEXray:ERRor:TYPE"](#) on page 509
- [":TRIGger:FLEXray:EVENT:TYPE"](#) on page 510
- [":TRIGger:FLEXray:FRAME:CCBase"](#) on page 511
- [":TRIGger:FLEXray:FRAME:CCRepetition"](#) on page 512
- [":TRIGger:FLEXray:FRAME:ID"](#) on page 513
- [":TRIGger:FLEXray:FRAME:TYPE"](#) on page 514
- [":TRIGger:FLEXray:SOURce"](#) on page 515
- [":TRIGger:FLEXray:TRIGger"](#) on page 516
- [":TRIGger:GLITch:GREaterthan"](#) on page 519
- [":TRIGger:GLITch:LESSthan"](#) on page 520
- [":TRIGger:GLITch:LEVel"](#) on page 521
- [":TRIGger:GLITch:POLarity"](#) on page 522
- [":TRIGger:GLITch:QUALifier"](#) on page 523
- [":TRIGger:GLITch:RANGe"](#) on page 524
- [":TRIGger:GLITch:SOURce"](#) on page 525
- [":TRIGger:HFReject"](#) on page 471
- [":TRIGger:HOLDoff"](#) on page 472
- [":TRIGger:I2S:ALIGNment"](#) on page 528
- [":TRIGger:I2S:AUDio"](#) on page 529
- [":TRIGger:I2S:CLOCK:SLOPe"](#) on page 530
- [":TRIGger:I2S:PATtern:DATA"](#) on page 531
- [":TRIGger:I2S:PATtern:FORMat"](#) on page 533
- [":TRIGger:I2S:RANGe"](#) on page 534
- [":TRIGger:I2S:RWIDth"](#) on page 536
- [":TRIGger:I2S:SOURce:CLOCK"](#) on page 537
- [":TRIGger:I2S:SOURce:DATA"](#) on page 538
- [":TRIGger:I2S:SOURce:WSElect"](#) on page 539
- [":TRIGger:I2S:TRIGger"](#) on page 540
- [":TRIGger:I2S:TWIDth"](#) on page 542
- [":TRIGger:I2S:WSLow"](#) on page 543
- [":TRIGger:IIC:PATtern:ADDRes"](#) on page 545
- [":TRIGger:IIC:PATtern:DATA"](#) on page 546

- ":TRIGger:IIC:PATtern:DATA2" on page 547
- ":TRIGger:IIC[:SOURce]:CLOCK" on page 548
- ":TRIGger:IIC[:SOURce]:DATA" on page 549
- ":TRIGger:IIC:TRIGger:QUALifier" on page 550
- ":TRIGger:IIC:TRIGger[:TYPE]" on page 551
- ":TRIGger:LIN:ID" on page 555
- ":TRIGger:LIN:PATtern:DATA" on page 556
- ":TRIGger:LIN:PATtern:DATA:LENGth" on page 558
- ":TRIGger:LIN:PATtern:FORMat" on page 559
- ":TRIGger:LIN:SAMPlepoint" on page 560
- ":TRIGger:LIN:SIGNal:BAUDrate" on page 561
- ":TRIGger:LIN:SIGNal:DEFinition" on page 740
- ":TRIGger:LIN:SOURce" on page 562
- ":TRIGger:LIN:STANdard" on page 563
- ":TRIGger:LIN:SYNCbreak" on page 564
- ":TRIGger:LIN:TRIGger" on page 565
- ":TRIGger:M1553:AUTosetup" on page 567
- ":TRIGger:M1553:PATtern:DATA" on page 568
- ":TRIGger:M1553:RTA" on page 569
- ":TRIGger:M1553:SOURce:LOWer" on page 570
- ":TRIGger:M1553:SOURce:UPPer" on page 571
- ":TRIGger:M1553:TYPE" on page 572
- ":TRIGger:MODE" on page 473
- ":TRIGger:NREJect" on page 474
- ":TRIGger:PATtern" on page 475
- ":TRIGger:SEQuence:COUNT" on page 574
- ":TRIGger:SEQuence:EDGE" on page 575
- ":TRIGger:SEQuence:FIND" on page 576
- ":TRIGger:SEQuence:PATtern" on page 577
- ":TRIGger:SEQuence:RESet" on page 578
- ":TRIGger:SEQuence:TIMer" on page 579
- ":TRIGger:SEQuence:TRIGger" on page 580
- ":TRIGger:SPI:CLOCK:SLOPe" on page 582
- ":TRIGger:SPI:CLOCK:TIMEout" on page 583
- ":TRIGger:SPI:FRAMing" on page 584

- [":TRIGger:SPI:PATtern:DATA"](#) on page 585
- [":TRIGger:SPI:PATtern:WIDTh"](#) on page 586
- [":TRIGger:SPI:SOURce:CLOCK"](#) on page 587
- [":TRIGger:SPI:SOURce:DATA"](#) on page 588
- [":TRIGger:SPI:SOURce:FRAMe"](#) on page 589
- [":TRIGger:SWEep"](#) on page 477
- [":TRIGger:THReshold"](#) on page 741
- [":TRIGger:TV:LINE"](#) on page 591
- [":TRIGger:TV:MODE"](#) on page 592
- [":TRIGger:TV:POLarity"](#) on page 593
- [":TRIGger:TV:SOURce"](#) on page 594
- [":TRIGger:TV:STANdard"](#) on page 595
- [":TRIGger:TV:TVMode"](#) on page 742
- [":TRIGger:UART:BASE"](#) on page 598
- [":TRIGger:UART:BAUDrate"](#) on page 599
- [":TRIGger:UART:BITorder"](#) on page 600
- [":TRIGger:UART:BURSt"](#) on page 601
- [":TRIGger:UART:DATA"](#) on page 602
- [":TRIGger:UART:IDLE"](#) on page 603
- [":TRIGger:UART:PARity"](#) on page 604
- [":TRIGger:UART:POLarity"](#) on page 605
- [":TRIGger:UART:QUALifier"](#) on page 606
- [":TRIGger:UART:SOURce:RX"](#) on page 607
- [":TRIGger:UART:SOURce:TX"](#) on page 608
- [":TRIGger:UART:TYPE"](#) on page 609
- [":TRIGger:UART:WIDTh"](#) on page 610
- [":TRIGger:USB:SOURce:DMINus"](#) on page 612
- [":TRIGger:USB:SOURce:DPLus"](#) on page 613
- [":TRIGger:USB:SPEed"](#) on page 614
- [":TRIGger:USB:TRIGger"](#) on page 615
- ["*TST \(Self Test\)"](#) on page 137
- TSTArt, [":MEASure:TSTArt"](#) on page 719
- TSTOp, [":MEASure:TSTOp"](#) on page 720
- TTAG, [":WAVEform:SEGmented:TTAG"](#) on page 637
- TV, [":TRIGger:TV Commands"](#) on page 590

- TVALue, ":MEASure:TVALue" on page 344
- TVOLt, ":MEASure:TVOLt" on page 721
- TWIDth, ":TRIGger:I2S:TWIDth" on page 542
- TX, ":TRIGger:UART:SOURce:TX" on page 608
- TXFRames, ":SBUS:UART:COUNt:TXFRames" on page 443
- TYPE Commands:
 - ":ACQuire:TYPE" on page 196
 - ":CHANnel<n>:PROBe:HEAD[:TYPE]" on page 228
 - ":WAVeform:TYPE" on page 643
 - ":TRIGger:FLEXray:ERRor:TYPE" on page 509
 - ":TRIGger:FLEXray:EVENT:TYPE" on page 510
 - ":TRIGger:FLEXray:FRAMe:TYPE" on page 514
 - ":TRIGger:IIC:TRIGger[:TYPE]" on page 551
 - ":TRIGger:M1553:TYPE" on page 572
 - ":TRIGger:UART:TYPE" on page 609

- U**
- UART Commands:
 - ":SBUS:UART:BASE" on page 439
 - ":SBUS:UART:COUNt:ERRor" on page 440
 - ":SBUS:UART:COUNt:RESet" on page 441
 - ":SBUS:UART:COUNt:RXFRames" on page 442
 - ":SBUS:UART:COUNt:TXFRames" on page 443
 - ":SBUS:UART:FRAMing" on page 444
 - ":TRIGger:UART:BASE" on page 598
 - ":TRIGger:UART:BAUDrate" on page 599
 - ":TRIGger:UART:BITorder" on page 600
 - ":TRIGger:UART:BURSt" on page 601
 - ":TRIGger:UART:DATA" on page 602
 - ":TRIGger:UART:IDLE" on page 603
 - ":TRIGger:UART:PARity" on page 604
 - ":TRIGger:UART:POLarity" on page 605
 - ":TRIGger:UART:QUALifier" on page 606
 - ":TRIGger:UART:SOURce:RX" on page 607
 - ":TRIGger:UART:SOURce:TX" on page 608
 - ":TRIGger:UART:TYPE" on page 609
 - ":TRIGger:UART:WIDTh" on page 610

- UNITs Commands:
 - [":CHANnel<n>:UNITs"](#) on page 235
 - [":EXtErnal:UNITs"](#) on page 263
 - [":MTESt:AMASk:UNITs"](#) on page 365
- UNSigned, [":WAVeform:UNSigned"](#) on page 644
- UPPer Commands:
 - [":MEASure:UPPer"](#) on page 723
 - [":TRIGger:M1553:SOURce:UPPer"](#) on page 571
- USB, [":TRIGger:USB Commands"](#) on page 611
- UTILization, [":SBUS:CAN:COUNt:UTILization"](#) on page 426
- V**
 - VAMplitude, [":MEASure:VAMPlitude"](#) on page 346
 - VAVerage, [":MEASure:VAVerage"](#) on page 347
 - VBASe, [":MEASure:VBASe"](#) on page 348
 - VDELta, [":MEASure:VDELta"](#) on page 724
 - VECTors, [":DISPlay:VECTors"](#) on page 253
 - VERNier, [":CHANnel<n>:VERNier"](#) on page 236
 - [":VIEW"](#) on page 180
 - VMAX, [":MEASure:VMAX"](#) on page 349
 - VMIN, [":MEASure:VMIN"](#) on page 350
 - VPP, [":MEASure:VPP"](#) on page 351
 - VRATio, [":MEASure:VRATio"](#) on page 352
 - VRMS, [":MEASure:VRMS"](#) on page 353
 - VSTArt, [":MEASure:VSTArt"](#) on page 725
 - VSTOp, [":MEASure:VSTOp"](#) on page 726
 - VTIMe, [":MEASure:VTIMe"](#) on page 354
 - VTOP, [":MEASure:VTOP"](#) on page 355
- W**
 - ["*WAI \(Wait To Continue\)"](#) on page 138
 - WAVeform Commands:
 - [":SAVE:WAVeform:FORMat"](#) on page 417
 - [":SAVE:WAVeform:LENGth"](#) on page 418
 - [":SAVE:WAVeform\[:STArt\]"](#) on page 416
 - [":WAVeform:BYTeorder"](#) on page 624
 - [":WAVeform:COUNt"](#) on page 625
 - [":WAVeform:DATA"](#) on page 626

- ":WAVEform:FORMat" on page 628
 - ":WAVEform:POINts" on page 629
 - ":WAVEform:POINts:MODE" on page 631
 - ":WAVEform:PREamble" on page 633
 - ":WAVEform:SEGmented:COUNT" on page 636
 - ":WAVEform:SEGmented:TTAG" on page 637
 - ":WAVEform:SOURce" on page 638
 - ":WAVEform:SOURce:SUBSource" on page 642
 - ":WAVEform:TYPE" on page 643
 - ":WAVEform:UNSigned" on page 644
 - ":WAVEform:VIEW" on page 645
 - ":WAVEform:XINcrement" on page 646
 - ":WAVEform:XORigin" on page 647
 - ":WAVEform:XREFerence" on page 648
 - ":WAVEform:YINcrement" on page 649
 - ":WAVEform:YORigin" on page 650
 - ":WAVEform:YREFerence" on page 651
 - WAVEforms Commands:
 - ":MTESt:COUNT:WAVEforms" on page 371
 - ":MTESt:RMODE:WAVEforms" on page 384
 - WIDTH Commands:
 - ":SBUS:SPI:WIDTH" on page 438
 - ":TRIGger:SPI:PATtern:WIDTH" on page 586
 - ":TRIGger:UART:WIDTH" on page 610
 - WINDOW, ":FUNction:WINDow" on page 280
 - WSElect, ":TRIGger:I2S:SOURce:WSElect" on page 539
 - WSLow, ":TRIGger:I2S:WSLow" on page 543
- X**
- X1, ":MTESt:SCALE:X1" on page 386
 - X1Position, ":MARKer:X1Position" on page 298
 - X1Y1source, ":MARKer:X1Y1source" on page 299
 - X2Position, ":MARKer:X2Position" on page 300
 - X2Y2source, ":MARKer:X2Y2source" on page 301
 - XDELta Commands:
 - ":MARKer:XDELta" on page 302
 - ":MTESt:AMASk:XDELta" on page 366

- [":MTESt:SCALe:XDELta"](#) on page 387
 - XINCrement, [":WAVEform:XINCrement"](#) on page 646
 - XMAX, [":MEASure:XMAX"](#) on page 356
 - XMIN, [":MEASure:XMIN"](#) on page 357
 - XORigin, [":WAVEform:XORigin"](#) on page 647
 - XREFerence, [":WAVEform:XREFerence"](#) on page 648
- Y**
- Y1, [":MTESt:SCALe:Y1"](#) on page 388
 - Y1Position, [":MARKer:Y1Position"](#) on page 303
 - Y2, [":MTESt:SCALe:Y2"](#) on page 389
 - Y2Position, [":MARKer:Y2Position"](#) on page 304
 - YDELta Commands:
 - [":MARKer:YDELta"](#) on page 305
 - [":MTESt:AMASk:YDELta"](#) on page 367
 - YINCrement, [":WAVEform:YINCrement"](#) on page 649
 - YORigin, [":WAVEform:YORigin"](#) on page 650
 - YREFerence, [":WAVEform:YREFerence"](#) on page 651

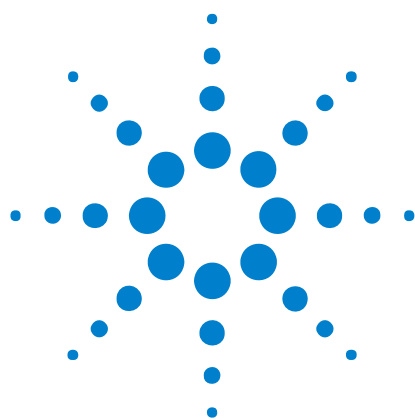

7 Obsolete and Discontinued Commands

Obsolete commands are older forms of commands that are provided to reduce customer rework for existing systems and programs (see "Obsolete Commands" on page 786).

Obsolete Command	Current Command Equivalent	Behavior Differences
ANALog<n>:BWLimit	:CHANnel<n>:BWLimit (see page 220)	
ANALog<n>:COUPling	:CHANnel<n>:COUPling (see page 221)	
ANALog<n>:INVert	:CHANnel<n>:INVert (see page 224)	
ANALog<n>:LABel	:CHANnel<n>:LABel (see page 225)	
ANALog<n>:OFFSet	:CHANnel<n>:OFFSet (see page 226)	
ANALog<n>:PROBe	:CHANnel<n>:PROBe (see page 227)	
ANALog<n>:PMODE	none	
ANALog<n>:RANGe	:CHANnel<n>:RANGe (see page 233)	
:CHANnel:ACTivity (see page 693)	:ACTivity (see page 142)	
:CHANnel:LABel (see page 694)	:CHANnel<n>:LABel (see page 225) or :DIGital<n>:LABel (see page 240)	use CHANnel<n>:LABel for analog channels and use DIGital<n>:LABel for digital channels
:CHANnel:THReshold (see page 695)	:POD<n>:THReshold (see page 395) or :DIGital<n>:THReshold (see page 243)	
:CHANnel2:SKEW (see page 696)	:CHANnel<n>:PROBe:SKEW (see page 230)	



7 Obsolete and Discontinued Commands

Obsolete Command	Current Command Equivalent	Behavior Differences
:CHANnel<n>:INPut (see page 697)	:CHANnel<n>:IMPedance (see page 223)	
:CHANnel<n>:PMODE (see page 698)	none	
:DISPlay:CONNect (see page 699)	:DISPlay:VECTors (see page 253)	
:DISPlay:ORDer (see page 700)	none	
:ERASe (see page 701)	:CDISplay (see page 149)	
:EXTernal:INPut (see page 702)	:EXTernal:IMPedance (see page 257)	
:EXTernal:PMODE (see page 703)	none	
FUNcTion1, FUNcTion2	:FUNcTion Commands (see page 264)	ADD not included
:FUNcTion:SOURce (see page 704)	:FUNcTion:SOURce1 (see page 277)	Obsolete command has ADD, SUBTRact, and MULTIPly parameters; current command has GOFT parameter.
:FUNcTion:VIEW (see page 705)	:FUNcTion:DISPlay (see page 268)	
:HARDcopy:DESTination (see page 706)	:HARDcopy:FILEname (see page 708)	
:HARDcopy:DEVIce (see page 707)	:HARDcopy:FORMat (see page 709)	PLOTter, THINKjet not supported; TIF, BMP, CSV, SEIko added
:HARDcopy:FILEname (see page 708)	:RECall:FILEname (see page 398) :SAVE:FILEname (see page 398)	
:HARDcopy:FORMat (see page 709)	:HARDcopy:APRinter (see page 284) :SAVE:IMAGe:FORMat (see page 409) :SAVE:WAVEform:FORMat (see page 417)	
:HARDcopy:GRAYscale (see page 710)	:HARDcopy:PALette (see page 289)	
:HARDcopy:IGColors (see page 711)	:HARDcopy:INKSaver (see page 287)	

Obsolete Command	Current Command Equivalent	Behavior Differences
:HARDcopy:PDRiver (see page 712)	:HARDcopy:APRinter (see page 284)	
:MEASure:LOWer (see page 713)	:MEASure:DEFine:THResholds (see page 316)	MEASure:DEFine:THResholds can define absolute values or percentage
:MEASure:SCRatch (see page 714)	:MEASure:CLEar (see page 314)	
:MEASure:TDELta (see page 715)	:MARKer:XDELta (see page 302)	
:MEASure:THResholds (see page 716)	:MEASure:DEFine:THResholds (see page 316)	MEASure:DEFine:THResholds can define absolute values or percentage
:MEASure:TMAX (see page 717)	:MEASure:XMAX (see page 356)	
:MEASure:TMIN (see page 718)	:MEASure:XMIN (see page 357)	
:MEASure:TStArt (see page 719)	:MARKer:X1Position (see page 298)	
:MEASure:TStOp (see page 720)	:MARKer:X2Position (see page 300)	
:MEASure:TVOLt (see page 721)	:MEASure:TVALue (see page 344)	TVALue measures additional values such as db, Vs, etc.
:MEASure:UPPer (see page 723)	:MEASure:DEFine:THResholds (see page 316)	MEASure:DEFine:THResholds can define absolute values or percentage
:MEASure:VDELta (see page 724)	:MARKer:YDELta (see page 305)	
:MEASure:VStArt (see page 725)	:MARKer:Y1Position (see page 303)	
:MEASure:VStOp (see page 726)	:MARKer:Y2Position (see page 304)	
:MTESt:AMASK:{SAVE STORE} (see page 727)	:SAVE:MASK[:StArt] (see page 413)	
:MTESt:AVERage (see page 728)	:ACQuire:TYPE AVERage (see page 196)	
:MTESt:AVERage:COUNt (see page 729)	:ACQuire:COUNt (see page 185)	
:MTESt:LOAD (see page 730)	:RECall:MASK[:StArt] (see page 400)	

7 Obsolete and Discontinued Commands

Obsolete Command	Current Command Equivalent	Behavior Differences
:MTESt:RUMode (see page 731)	:MTESt:RMODe (see page 377)	
:MTESt:RUMode:SOFailure (see page 732)	:MTESt:RMODe:FACTion:STOP (see page 381)	
:MTESt:{START STOP} (see page 733)	:RUN (see page 174) or :STOP (see page 178)	
:MTESt:TRIGger:SOURce (see page 734)	:TRIGger Commands (see page 467)	There are various commands for setting the source with different types of triggers.
:PRINt? (see page 735)	:DISPlay:DATA? (see page 247)	
:TIMebase:DELaY (see page 737)	:TIMebase:POSition (see page 458) or :TIMebase:WINDow:POSition (see page 464)	TIMebase:POSition is position value of main time base; TIMebase:WINDow:POSition is position value of zoomed (delayed) time base window.
:TRIGger:CAN:ACKnowledge (see page 738)	none	
:TRIGger:CAN:SIGNal:DEFinition (see page 739)	none	
:TRIGger:LIN:SIGNal:DEFinition (see page 740)	none	
:TRIGger:THReshold (see page 741)	:POD<n>:THReshold (see page 395) or :DIGital<n>:THReshold (see page 243)	
:TRIGger:TV:TVMode (see page 742)	:TRIGger:TV:MODE (see page 592)	

Discontinued Commands

Discontinued commands are commands that were used by previous oscilloscopes, but are not supported by the InfiniiVision 7000 Series oscilloscopes. Listed below are the Discontinued commands and the nearest equivalent command available (if any).

Discontinued Command	Current Command Equivalent	Comments
ASTore	:DISPlay:PERsistence INFinite (see page 251)	
CHANnel:MATH	:FUNctioN:OPERation (see page 273)	ADD not included

Discontinued Command	Current Command Equivalent	Comments
CHANnel<n>:PROTeCt	:CHANnel<n>:PROTection (see page 232)	Previous form of this command was used to enable/disable 50Ω protection. The new command resets a tripped protect and the query returns the status of TRIPed or NORMal.
DISPlay:INVerse	none	
DISPlay:COLumn	none	
DISPlay:FREeze	none	
DISPlay:GRID	none	
DISPlay:LINE	none	
DISPlay:PIXel	none	
DISPlay:POSition	none	
DISPlay:ROW	none	
DISPlay:TEXT	none	
FUNcTION:MOVE	none	
FUNcTION:PEAKs	none	
HARDcopy:ADDReSS	none	Only parallel printer port is supported. GPIB printing not supported
MASK	none	All commands discontinued, feature not available
SYSTem:KEY	none	
TEST:ALL	*TST (Self Test) (see page 137)	
TRACE subsystem	none	All commands discontinued, feature not available
TRIGger:ADVanced subsystem		Use new GLITch, PATtern, or TV trigger modes
TRIGger:TV:FIEld	:TRIGger:TV:MODE (see page 592)	
TRIGger:TV:TVHFrej		
TRIGger:TV:VIR	none	
VAUToscale	none	

7 Obsolete and Discontinued Commands

Discontinued Parameters Some previous oscilloscope queries returned control setting values of OFF and ON. The InfiniiVision 7000 Series oscilloscopes only return the enumerated values 0 (for off) and 1 (for on).

:CHANnel:ACTivity

O (see [page 786](#))

Command Syntax :CHANnel:ACTivity

The :CHANnel:ACTivity command clears the cumulative edge variables for the next activity query.

NOTE

The :CHANnel:ACTivity command is an obsolete command provided for compatibility to previous oscilloscopes. Use the :ACTivity command (see [page 142](#)) instead.

Query Syntax :CHANnel:ACTivity?

The :CHANnel:ACTivity? query returns the active edges since the last clear, and returns the current logic levels.

Return Format <edges>, <levels><NL>

<edges> ::= presence of edges (32-bit integer in NR1 format).

<levels> ::= logical highs or lows (32-bit integer in NR1 format).

NOTE

A bit equal to zero indicates that no edges were detected at the specified threshold since the last clear on that channel. Edges may have occurred that were not detected because of the threshold setting.

A bit equal to one indicates that edges have been detected at the specified threshold since the last clear on that channel.

:CHANnel:LABel

O (see [page 786](#))

Command Syntax :CHANnel:LABel <source_text><string>
<source_text> ::= {CHANnel1 | CHANnel2 | DIGital0,...,DIGital15}
<string> ::= quoted ASCII string

The :CHANnel:LABel command sets the source text to the string that follows. Setting a channel will also result in the name being added to the label list.

NOTE

The :CHANnel:LABel command is an obsolete command provided for compatibility to previous oscilloscopes. Use the :CHANnel<n>:LABel command (see [page 225](#)) or :DIGital<n>:LABel command (see [page 240](#)) for the InfiniiVision 7000 Series oscilloscopes.

Query Syntax :CHANnel:LABel?

The :CHANnel:LABel? query returns the label associated with a particular analog channel.

Return Format <string><NL>
<string> ::= quoted ASCII string

:CHANnel:THReshold

O (see [page 786](#))

Command Syntax :CHANnel:THReshold <channel group>, <threshold type> [, <value>]
 <channel group> ::= {POD1 | POD2}
 <threshold type> ::= {CMOS | ECL | TTL | USERdef}
 <value> ::= voltage for USERdef in NR3 format [volt_type]
 [volt_type] ::= {V | mV (-3) | uV (-6)}

The :CHANnel:THReshold command sets the threshold for a group of channels. The threshold is either set to a predefined value or to a user-defined value. For the predefined value, the voltage parameter is ignored.

NOTE

The :CHANnel:THReshold command is an obsolete command provided for compatibility to previous oscilloscopes. Use the :POD<n>:THReshold command (see [page 395](#)) or :DIGital<n>:THReshold command (see [page 243](#)) for the InfiniiVision 7000 Series oscilloscopes.

Query Syntax :CHANnel:THReshold? <channel group>

The :CHANnel:THReshold? query returns the voltage and threshold text for a specific group of channels.

Return Format <threshold type> [, <value>]<NL>
 <threshold type> ::= {CMOS | ECL | TTL | USERdef}
 <value> ::= voltage for USERdef (float 32 NR3)

NOTE

- CMOS = 2.5V
- TTL = 1.5V
- ECL = -1.3V
- USERdef ::= -6.0V to 6.0V

:CHANnel2:SKEW

O (see [page 786](#))

Command Syntax :CHANnel2:SKEW <skew value>
<skew value> ::= skew time in NR3 format
<skew value> ::= -100 ns to +100 ns

The :CHANnel2:SKEW command sets the skew between channels 1 and 2. The maximum skew is +/- 100 ns. You can use the oscilloscope's analog probe skew control to remove cable delay errors between channel 1 and channel 2.

NOTE

The :CHANnel2:SKEW command is an obsolete command provided for compatibility to previous oscilloscopes. Use the :CHANnel<n>:PROBe:SKEW command (see [page 230](#)) instead.

NOTE

This command is only valid for the two channel oscilloscope models.

Query Syntax :CHANnel2:SKEW?

The :CHANnel2:SKEW? query returns the current probe skew setting for the selected channel.

Return Format <skew value><NL>
<skew value> ::= skew value in NR3 format

See Also • "Introduction to :CHANnel<n> Commands" on page 218

:CHANnel<n>:INPut

O (see [page 786](#))

Command Syntax :CHANnel<n>:INPut <impedance>
 <impedance> ::= {ONEMeg | FIFTy}
 <n> ::= {1 | 2 | 3 | 4} for the four channel oscilloscope models
 <n> ::= {1 | 2} for the two channel oscilloscope models

The :CHANnel<n>:INPut command selects the input impedance setting for the specified channel. The legal values for this command are ONEMeg (1 MΩ) and FIFTy (50Ω).

NOTE

The :CHANnel<n>:INPut command is an obsolete command provided for compatibility to previous oscilloscopes. Use the :CHANnel<n>:IMPedance command (see [page 223](#)) instead.

Query Syntax :CHANnel<n>:INPut?

The :CHANnel<n>:INPut? query returns the current input impedance setting for the specified channel.

Return Format <impedance value><NL>
 <impedance value> ::= {ONEM | FIFT}

:CHANnel<n>:PMODE

O (see [page 786](#))

Command Syntax :CHANnel<n>:PMODE <pmode value>
<pmode value> ::= {AUTO | MANual}
<n> ::= {1 | 2 | 3 | 4} for the four channel oscilloscope models
<n> ::= {1 | 2} for the two channel oscilloscope models

The probe sense mode is controlled internally and cannot be set. If a probe with sense is connected to the specified channel, auto sensing is enabled; otherwise, the mode is manual.

If the PMODE sent matches the oscilloscope's setting, the command will be accepted. Otherwise, a setting conflict error is generated.

NOTE

The :CHANnel<n>:PMODE command is an obsolete command provided for compatibility to previous oscilloscopes.

Query Syntax :CHANnel<n>:PMODE?

The :CHANnel<n>:PMODE? query returns AUT if an autosense probe is attached and MAN otherwise.

Return Format <pmode value><NL>
<pmode value> ::= {AUT | MAN}

:DISPlay:CONNEct

O (see [page 786](#))

Command Syntax :DISPlay:CONNEct <connect>
 <connect> ::= {{ 1 | ON} | {0 | OFF}}

The :DISPlay:CONNEct command turns vectors on and off. When vectors are turned on, the oscilloscope displays lines connecting sampled data points. When vectors are turned off, only the sampled data is displayed.

NOTE

The :DISPlay:CONNEct command is an obsolete command provided for compatibility to previous oscilloscopes. Use the :DISPlay:VECTors command (see [page 253](#)) instead.

Query Syntax :DISPlay:CONNEct?

The :DISPlay:CONNEct? query returns the current state of the vectors setting.

Return Format <connect><NL>
 <connect> ::= {1 | 0}

See Also • [":DISPlay:VECTors"](#) on page 253

:DISPlay:ORDer

O (see [page 786](#))

Query Syntax :DISPlay:ORDer?

The :DISPlay:ORDer? query returns a list of digital channel numbers in screen order, from top to bottom, separated by commas. Busing is displayed as digital channels with no separator. For example, in the following list, the bus consists of digital channels 4 and 5: DIG1, DIG4 DIG5, DIG7.

NOTE

The :DISPlay:ORDer command is an obsolete command provided for compatibility to previous oscilloscopes. This command is only available on the MSO models.

Return Format

<order><NL>

<order> ::= Unquoted ASCII string

NOTE

A return value is included for each digital channel. A return value of NONE indicates that a channel is turned off.

See Also • [":DIGital<n>:POSition"](#) on page 241

Example Code

```
' DISP_ORDER - Set the order the channels are displayed on the
' analyzer. You can enter between 1 and 32 channels at one time.
' If you leave out channels, they will not be displayed.

' Display ONLY channel 0 and channel 10 in that order.
myScope.WriteString ":DISPLAY:ORDER 0,10"
```

Example program from the start: ["VISA COM Example in Visual Basic"](#) on page 812

:ERASe**O** (see [page 786](#))**Command Syntax** :ERASe

The :ERASe command erases the screen.

NOTE

The :ERASe command is an obsolete command provided for compatibility to previous oscilloscopes. Use the :CDISplay command (see [page 149](#)) instead.

:EXternal:INPut

O (see [page 786](#))

Command Syntax :EXternal:INPut <impedance>
<impedance> ::= {ONEMeg | FIFTy}

The :EXternal:IMPedance command selects the input impedance setting for the external trigger. The legal values for this command are ONEMeg (1 M Ω) and FIFTy (50 Ω).

NOTE

The :EXternal:INPut command is an obsolete command provided for compatibility to previous oscilloscopes. Use the :EXternal:IMPedance command (see [page 257](#)) instead.

Query Syntax :EXternal:INPut?

The :EXternal:INPut? query returns the current input impedance setting for the external trigger.

Return Format <impedance value><NL>
<impedance value> ::= {ONEM | FIFT}

- See Also**
- "[Introduction to :EXternal Trigger Commands](#)" on page 254
 - "[Introduction to :TRIGger Commands](#)" on page 467
 - "[:CHANnel<n>:IMPedance](#)" on page 223

:EXternal:PMODE

O (see [page 786](#))

Command Syntax :EXternal:PMODE <pmode value>

<pmode value> ::= {AUTO | MANual}

The probe sense mode is controlled internally and cannot be set. If a probe with sense is connected to the specified channel, auto sensing is enabled; otherwise, the mode is manual.

If the pmode sent matches the oscilloscope's setting, the command will be accepted. Otherwise, a setting conflict error is generated.

NOTE

The :EXternal:PMODE command is an obsolete command provided for compatibility to previous oscilloscopes.

Query Syntax :EXternal:PMODE?

The :EXternal:PMODE? query returns AUT if an autosense probe is attached and MAN otherwise.

Return Format <pmode value><NL>

<pmode value> ::= {AUT | MAN}

:FUNCTION:SOURce

O (see [page 786](#))

Command Syntax :FUNCTION:SOURce <value>
 <value> ::= {CHANnel<n> | ADD | SUBTract | MULTiply}
 <n> ::= {1 | 2 | 3 | 4} for the four channel oscilloscope models
 <n> ::= {1 | 2} for the two channel oscilloscope models

The :FUNCTION:SOURce command is only used when an FFT (Fast Fourier Transform), DIFF, or INT operation is selected (see the:FUNCTION:OPERation command for more information about selecting an operation). The :FUNCTION:SOURce command selects the source for function operations. Choose CHANnel<n>, or ADD, SUBT, or MULT to specify the desired source for function DIFFerentiate, INTegrate, and FFT operations specified by the :FUNCTION:OPERation command.

NOTE

The :FUNCTION:SOURce command is an obsolete command provided for compatibility to previous oscilloscopes. Use the :FUNCTION:SOURce1 command (see [page 277](#)) instead.

Query Syntax :FUNCTION:SOURce?

The :FUNCTION:SOURce? query returns the current source for function operations.

Return Format <value><NL>
 <value> ::= {CHAN<n> | ADD | SUBT | MULT}
 <n> ::= {1 | 2 | 3 | 4} for the four channel oscilloscope models
 <n> ::= {1 | 2} for the two channel oscilloscope models

- See Also**
- "[Introduction to :FUNCTION Commands](#)" on page 266
 - "[:FUNCTION:OPERation](#)" on page 273

:FUNCTION:VIEW

O (see [page 786](#))

Command Syntax :FUNCTION:VIEW <view>
 <view> ::= {{1 | ON} | {0 | OFF}}

The :FUNCTION:VIEW command turns the selected function on or off. When ON is selected, the function performs as specified using the other FUNCTION commands. When OFF is selected, function is neither calculated nor displayed.

NOTE The :FUNCTION:VIEW command is provided for backward compatibility to previous oscilloscopes. Use the :FUNCTION:DISPLAY command (see [page 268](#)) instead.

Query Syntax :FUNCTION:VIEW?

The :FUNCTION:VIEW? query returns the current state of the selected function.

Return Format <view><NL>
 <view> ::= {1 | 0}

:HARDcopy:DESTination

O (see [page 786](#))

Command Syntax :HARDcopy:DESTination <destination>
<destination> ::= {CENTronics | FLOppy}

The :HARDcopy:DESTination command sets the hardcopy destination.

NOTE

The :HARDcopy:DESTination command is an obsolete command provided for compatibility to previous oscilloscopes. Use the :HARDcopy:FILEname command (see [page 708](#)) instead.

Query Syntax :HARDcopy:DESTination?

The :HARDcopy:DESTination? query returns the selected hardcopy destination.

Return Format <destination><NL>
<destination> ::= {CENT | FLOP}

- See Also**
- "[Introduction to :HARDcopy Commands](#)" on page 282
 - "[:HARDcopy:FORMat](#)" on page 709

:HARDcopy:DEVICE

O (see [page 786](#))

Command Syntax :HARDcopy:DEVICE <device>
 <device> ::= {TIFF | GIF | BMP | LASerjet | EPSON | DESKjet
 | BWDeskjet | SEIKO}

The HARDcopy:DEVICE command sets the hardcopy device type.

NOTE

BWDeskjet option refers to the monochrome Deskjet printer.

NOTE

The :HARDcopy:DEVICE command is an obsolete command provided for compatibility to previous oscilloscopes. Use the :HARDcopy:FORMat command (see [page 709](#)) instead.

Query Syntax :HARDcopy:DEVICE?

The :HARDcopy:DEVICE? query returns the selected hardcopy device type.

Return Format <device><NL>
 <device> ::= {TIFF | GIF | BMP | LAS | EPS | DESK | BWD | SEIK}

:HARDcopy:FILENAME

O (see [page 786](#))

Command Syntax :HARDcopy:FILENAME <string>
<string> ::= quoted ASCII string

The HARDcopy:FILENAME command sets the output filename for those print formats whose output is a file.

NOTE

The :HARDcopy:FILENAME command is an obsolete command provided for compatibility to previous oscilloscopes. Use the :SAVE:FILENAME command (see [page 405](#)) and :RECall:FILENAME command (see [page 398](#)) instead.

Query Syntax :HARDcopy:FILENAME?

The :HARDcopy:FILENAME? query returns the current hardcopy output filename.

Return Format <string><NL>
<string> ::= quoted ASCII string

- See Also**
- "[Introduction to :HARDcopy Commands](#)" on page 282
 - "[:HARDcopy:FORMat](#)" on page 709

:HARDcopy:FORMat

O (see [page 786](#))

Command Syntax :HARDcopy:FORMat <format>

```
<format> ::= {BMP[24bit] | BMP8bit | PNG | CSV | ASCiixy | BINary
              | PRINter0 | PRINter1}
```

The HARDcopy:FORMat command sets the hardcopy format type.

PRINter0 and PRINter1 are only valid when printers are connected to the oscilloscope's USB ports. (The first printer connected/identified is PRINter0 and the second is PRINter1.)

NOTE

The :HARDcopy:FORMat command is an obsolete command provided for compatibility to previous oscilloscopes. Use the :SAVE:IMAGE:FORMat (see [page 409](#)), :SAVE:WAVEform:FORMat (see [page 417](#)), and :HARDcopy:APRinter (see [page 284](#)) commands instead.

Query Syntax :HARDcopy:FORMat?

The :HARDcopy:FORMat? query returns the selected hardcopy format type.

Return Format <format><NL>

```
<format> ::= {BMP | BMP8 | PNG | CSV | ASC | BIN | PRIN0 | PRIN1}
```

See Also • ["Introduction to :HARDcopy Commands"](#) on [page 282](#)

:HARDcopy:GRAYscale

O (see [page 786](#))

Command Syntax :HARDcopy:GRAYscale <gray>
<gray> ::= {{OFF | 0} | {ON | 1}}

The :HARDcopy:GRAYscale command controls whether grayscaling is performed in the hardcopy dump.

NOTE

The :HARDcopy:GRAYscale command is an obsolete command provided for compatibility to previous oscilloscopes. Use the :HARDcopy:PALETTE command (see [page 289](#)) instead. (":HARDcopy:GRAYscale ON" is the same as ":HARDcopy:PALETTE GRAYscale" and ":HARDcopy:GRAYscale OFF" is the same as ":HARDcopy:PALETTE COLor".)

Query Syntax :HARDcopy:GRAYscale?

The :HARDcopy:GRAYscale? query returns a flag indicating whether grayscaling is performed in the hardcopy dump.

Return Format <gray><NL>
<gray> ::= {0 | 1}

See Also • ["Introduction to :HARDcopy Commands"](#) on page 282

:HARDcopy:IGColors

O (see [page 786](#))

Command Syntax :HARDcopy:IGColors <value>
 <value> ::= {{OFF | 0} | {ON | 1}}

The HARDcopy:IGColors command controls whether the graticule colors are inverted or not.

NOTE

The :HARDcopy:IGColors command is an obsolete command provided for compatibility to previous oscilloscopes. Use the :HARDcopy:INKSaver (see [page 287](#)) command instead.

Query Syntax :HARDcopy:IGColors?

The :HARDcopy:IGColors? query returns a flag indicating whether graticule colors are inverted or not.

Return Format <value><NL>
 <value> ::= {0 | 1}

See Also • ["Introduction to :HARDcopy Commands"](#) on page 282

:HARDcopy:PDRiver

O (see [page 786](#))

Command Syntax :HARDcopy:PDRiver <driver>

```
<driver> ::= {AP2Xxx | AP21xx | {AP2560 | AP25} | {DJ350 | DJ35} |
             DJ6xx | {DJ630 | DJ63} | DJ6Special | DJ6Photo |
             DJ8Special | DJ8xx | DJ9Vip | OJPRokx50 | DJ9xx | GVIP |
             DJ55xx | {PS470 | PS47} {PS100 | PS10} | CLASer |
             MLASer | LJFastraster | POSTscript}
```

The HARDcopy:PDRiver command sets the hardcopy printer driver used for the selected printer.

If the correct driver for the selected printer can be identified, it will be selected and cannot be changed.

NOTE

The :HARDcopy:PDRiver command is an obsolete command provided for compatibility to previous oscilloscopes. Use the :HARDcopy:APRinter (see [page 284](#)) command instead.

Query Syntax :HARDcopy:PDRiver?

The :HARDcopy:PDRiver? query returns the selected hardcopy printer driver.

Return Format <driver><NL>

```
<driver> ::= {AP2X | AP21 | AP25 | DJ35 | DJ6 | DJ63 | DJ6S | DJ6P |
             DJ8S | DJ8 | DJ9V | OJPR | DJ9 | GVIP | DJ55 | PS10 |
             PS47 | CLAS | MLAS | LJF | POST}
```

- See Also**
- "Introduction to :HARDcopy Commands" on page 282
 - ":HARDcopy:FORMat" on page 709

:MEASure:LOWer

O (see [page 786](#))

Command Syntax :MEASure:LOWer <voltage>

The :MEASure:LOWer command sets the lower measurement threshold value. This value and the UPPER value represent absolute values when the thresholds are ABSolute and percentage when the thresholds are PERCent as defined by the :MEASure:DEFine THResholds command.

NOTE

The :MEASure:LOWer command is obsolete and is provided for backward compatibility to previous oscilloscopes. Use the :MEASure:DEFine THResholds command (see [page 316](#)) instead.

Query Syntax :MEASure:LOWer?

The :MEASure:LOWer? query returns the current lower threshold level.

Return Format <voltage><NL>

<voltage> ::= the user-defined lower threshold in volts in NR3 format

- See Also**
- "[Introduction to :MEASure Commands](#)" on page 312
 - "[:MEASure:THResholds](#)" on page 716
 - "[:MEASure:UPPer](#)" on page 723

:MEASure:SCRatch

O (see [page 786](#))

Command Syntax :MEASure:SCRatch

The :MEASure:SCRatch command clears all selected measurements and markers from the screen.

NOTE

The :MEASure:SCRatch command is obsolete and is provided for backward compatibility to previous oscilloscopes. Use the :MEASure:CLEar command (see [page 314](#)) instead.

:MEASure:TDELta

O (see [page 786](#))

Query Syntax :MEASure:TDELta?

The :MEASure:TDELta? query returns the time difference between the Tstop marker (X2 cursor) and the Tstart marker (X1 cursor).

$Tdelta = Tstop - Tstart$

Tstart is the time at the start marker (X1 cursor) and Tstop is the time at the stop marker (X2 cursor). No measurement is made when the :MEASure:TDELta? query is received by the oscilloscope. The delta time value that is output is the current value. This is the same value as the front-panel cursors delta X value.

NOTE

The :MEASure:TDELta command is an obsolete command provided for compatibility to previous oscilloscopes. Use the :MARKer:XDELta command (see [page 302](#)) instead.

Return Format <value><NL>

<value> ::= time difference between start and stop markers in NR3 format

- See Also**
- "[Introduction to :MARKer Commands](#)" on page 296
 - "[Introduction to :MEASure Commands](#)" on page 312
 - "[:MARKer:X1Position](#)" on page 298
 - "[:MARKer:X2Position](#)" on page 300
 - "[:MARKer:XDELta](#)" on page 302
 - "[:MEASure:TSTArt](#)" on page 719
 - "[:MEASure:TSTOp](#)" on page 720

:MEASure:THResholds

O (see [page 786](#))

Command Syntax :MEASure:THResholds {T1090 | T2080 | VOLTage}

The :MEASure:THResholds command selects the thresholds used when making time measurements.

NOTE

The :MEASure:THResholds command is obsolete and is provided for backward compatibility to previous oscilloscopes. Use the :MEASure:DEFine THResholds command (see [page 316](#)) instead.

Query Syntax :MEASure:THResholds?

The :MEASure:THResholds? query returns the current thresholds selected when making time measurements.

Return Format {T1090 | T2080 | VOLTage}<NL>

{T1090} uses the 10% and 90% levels of the selected waveform.

{T2080} uses the 20% and 80% levels of the selected waveform.

{VOLTage} uses the upper and lower voltage thresholds set by the UPPER and LOWER commands on the selected waveform.

- See Also**
- ["Introduction to :MEASure Commands"](#) on [page 312](#)
 - [":MEASure:LOWer"](#) on [page 713](#)
 - [":MEASure:UPPer"](#) on [page 723](#)

:MEASure:TMAX

O (see [page 786](#))

Command Syntax :MEASure:TMAX [<source>]

<source> ::= {CHANnel<n> | FUNCTION | MATH}

<n> ::= {1 | 2 | 3 | 4} for the four channel oscilloscope models

<n> ::= {1 | 2} for the two channel oscilloscope models

The :MEASure:TMAX command installs a screen measurement and starts an X-at-Max-Y measurement on the selected waveform. If the optional source is specified, the current source is modified.

NOTE

The :MEASure:TMAX command is obsolete and is provided for backward compatibility to previous oscilloscopes. Use the :MEASure:XMAX command (see [page 356](#)) instead.

Query Syntax :MEASure:TMAX? [<source>]

The :MEASure:TMAX? query returns the horizontal axis value at which the maximum vertical value occurs on the current source. If the optional source is specified, the current source is modified. If all channels are off, the query returns 9.9E+37.

Return Format <value><NL>

<value> ::= time at maximum in NR3 format

- See Also**
- ["Introduction to :MEASure Commands"](#) on page 312
 - [":MEASure:TMIN"](#) on page 718
 - [":MEASure:XMAX"](#) on page 356
 - [":MEASure:XMIN"](#) on page 357

:MEASure:TMIN

O (see [page 786](#))

Command Syntax :MEASure:TMIN [<source>]

<source> ::= {CHANnel<n> | FUNCTION | MATH}

<n> ::= {1 | 2 | 3 | 4} for the four channel oscilloscope models

<n> ::= {1 | 2} for the two channel oscilloscope models

The :MEASure:TMIN command installs a screen measurement and starts an X-at-Min-Y measurement on the selected waveform. If the optional source is specified, the current source is modified.

NOTE

The :MEASure:TMIN command is obsolete and is provided for backward compatibility to previous oscilloscopes. Use the :MEASure:XMIN command (see [page 357](#)) instead.

Query Syntax :MEASure:TMIN? [<source>]

The :MEASure:TMIN? query returns the horizontal axis value at which the minimum vertical value occurs on the current source. If the optional source is specified, the current source is modified. If all channels are off, the query returns 9.9E+37.

Return Format <value><NL>

<value> ::= time at minimum in NR3 format

- See Also**
- "[Introduction to :MEASure Commands](#)" on page 312
 - "[:MEASure:TMAX](#)" on page 717
 - "[:MEASure:XMAX](#)" on page 356
 - "[:MEASure:XMIN](#)" on page 357

:MEASure:TSTArt

O (see [page 786](#))

Command Syntax :MEASure:TSTArt <value> [suffix]
 <value> ::= time at the start marker in seconds
 [suffix] ::= {s | ms | us | ns | ps}

The :MEASure:TSTArt command moves the start marker (X1 cursor) to the specified time with respect to the trigger time.

NOTE

The short form of this command, TSTA, does not follow the defined Long Form to Short Form Truncation Rules (see [page 788](#)). The normal short form "TST" would be the same for both TSTArt and TSTOp, so sending TST for the TSTArt command produces an error.

NOTE

The :MEASure:TSTArt command is an obsolete command provided for compatibility to previous oscilloscopes. Use the :MARKer:X1Position command (see [page 298](#)) instead.

Query Syntax :MEASure:TSTArt?

The :MEASure:TSTArt? query returns the time at the start marker (X1 cursor).

Return Format <value><NL>
 <value> ::= time at the start marker in NR3 format

- See Also**
- ["Introduction to :MARKer Commands"](#) on page 296
 - ["Introduction to :MEASure Commands"](#) on page 312
 - [":MARKer:X1Position"](#) on page 298
 - [":MARKer:X2Position"](#) on page 300
 - [":MARKer:XDELta"](#) on page 302
 - [":MEASure:TDELta"](#) on page 715
 - [":MEASure:TSTOP"](#) on page 720

:MEASure:TSTOp

O (see [page 786](#))

Command Syntax :MEASure:TSTOp <value> [suffix]

<value> ::= time at the stop marker in seconds
[suffix] ::= {s | ms | us | ns | ps}

The :MEASure:TSTOp command moves the stop marker (X2 cursor) to the specified time with respect to the trigger time.

NOTE

The short form of this command, TSTO, does not follow the defined Long Form to Short Form Truncation Rules (see [page 788](#)). The normal short form "TST" would be the same for both TSTArt and TSTOp, so sending TST for the TSTOp command produces an error.

NOTE

The :MEASure:TSTOp command is an obsolete command provided for compatibility to previous oscilloscopes. Use the :MARKer:X2Position command (see [page 300](#)) instead.

Query Syntax :MEASure:TSTOp?

The :MEASure:TSTOp? query returns the time at the stop marker (X2 cursor).

Return Format <value><NL>

<value> ::= time at the stop marker in NR3 format

- See Also**
- "[Introduction to :MARKer Commands](#)" on page 296
 - "[Introduction to :MEASure Commands](#)" on page 312
 - "[:MARKer:X1Position](#)" on page 298
 - "[:MARKer:X2Position](#)" on page 300
 - "[:MARKer:XDELta](#)" on page 302
 - "[:MEASure:TDELta](#)" on page 715
 - "[:MEASure:TSTArt](#)" on page 719

:MEASure:TVOLt

O (see [page 786](#))

Query Syntax :MEASure:TVOLt? <value>, [<slope>]<occurrence>[,<source>]

<value> ::= the voltage level that the waveform must cross.

<slope> ::= direction of the waveform. A rising slope is indicated by a plus sign (+). A falling edge is indicated by a minus sign (-).

<occurrence> ::= the transition to be reported. If the occurrence number is one, the first crossing is reported. If the number is two, the second crossing is reported, etc.

<source> ::= {<digital channels> | CHANNEL<n> | FUNCTION | MATH}

<digital channels> ::= {DIGital0,..,DIGital15} for the MSO models

<n> ::= {1 | 2 | 3 | 4} for the four channel oscilloscope models

<n> ::= {1 | 2} for the two channel oscilloscope models

When the :MEASure:TVOLt? query is sent, the displayed signal is searched for the specified voltage level and transition. The time interval between the trigger event and this defined occurrence is returned as the response to the query.

The specified voltage can be negative or positive. To specify a negative voltage, use a minus sign (-). The sign of the slope selects a rising (+) or falling (-) edge. If no sign is specified for the slope, it is assumed to be the rising edge.

The magnitude of the occurrence defines the occurrence to be reported. For example, +3 returns the time for the third time the waveform crosses the specified voltage level in the positive direction. Once this voltage crossing is found, the oscilloscope reports the time at that crossing in seconds, with the trigger point (time zero) as the reference.

If the specified crossing cannot be found, the oscilloscope reports +9.9E+37. This value is returned if the waveform does not cross the specified voltage, or if the waveform does not cross the specified voltage for the specified number of times in the direction specified.

If the optional source parameter is specified, the current source is modified.

NOTE

The :MEASure:TVOLt command is obsolete and is provided for backward compatibility to previous oscilloscopes. Use the :MEASure:TVALue command (see [page 344](#)) for the InfiniiVision 7000 Series oscilloscopes.

Return Format <value><NL>

7 Obsolete and Discontinued Commands

<value> ::= time in seconds of the specified voltage crossing
in NR3 format

:MEASure:UPPer

O (see [page 786](#))

Command Syntax :MEASure:UPPer <value>

The :MEASure:UPPer command sets the upper measurement threshold value. This value and the LOWer value represent absolute values when the thresholds are ABSolute and percentage when the thresholds are PERCent as defined by the :MEASure:DEFine THResholds command.

NOTE

The :MEASure:UPPer command is obsolete and is provided for backward compatibility to previous oscilloscopes. Use the :MEASure:DEFine THResholds command (see [page 316](#)) instead.

Query Syntax :MEASure:UPPer?

The :MEASure:UPPer? query returns the current upper threshold level.

Return Format <value><NL>

<value> ::= the user-defined upper threshold in NR3 format

- See Also**
- ["Introduction to :MEASure Commands"](#) on page 312
 - [":MEASure:LOWer"](#) on page 713
 - [":MEASure:THResholds"](#) on page 716

:MEASure:VDELta

O (see [page 786](#))

Query Syntax :MEASure:VDELta?

The :MEASure:VDELta? query returns the voltage difference between vertical marker 1 (Y1 cursor) and vertical marker 2 (Y2 cursor). No measurement is made when the :MEASure:VDELta? query is received by the oscilloscope. The delta value that is returned is the current value. This is the same value as the front-panel cursors delta Y value.

VDELta = value at marker 2 - value at marker 1

NOTE

The :MEASure:VDELta command is an obsolete command provided for compatibility to previous oscilloscopes. Use the :MARKer:YDELta command (see [page 305](#)) instead.

Return Format <value><NL>

<value> ::= delta V value in NR1 format

- See Also**
- "[Introduction to :MARKer Commands](#)" on page 296
 - "[Introduction to :MEASure Commands](#)" on page 312
 - "[:MARKer:Y1Position](#)" on page 303
 - "[:MARKer:Y2Position](#)" on page 304
 - "[:MARKer:YDELta](#)" on page 305
 - "[:MEASure:TDELta](#)" on page 715
 - "[:MEASure:TSTArt](#)" on page 719

:MEASure:VSTArt

O (see [page 786](#))

Command Syntax :MEASure:VSTArt <vstart_argument>
 <vstart_argument> ::= value for vertical marker 1

The :MEASure:VSTArt command moves the vertical marker (Y1 cursor) to the specified value corresponding to the selected source. The source can be selected by the MARKer:X1Y1source command.

NOTE The short form of this command, VSTA, does not follow the defined Long Form to Short Form Truncation Rules (see [page 788](#)). The normal short form, VST, would be the same for both VSTArt and VSTOp, so sending VST for the VSTArt command produces an error.

NOTE The :MEASure:VSTArt command is an obsolete command provided for compatibility to previous oscilloscopes. Use the :MARKer:Y1Position command (see [page 303](#)) instead.

Query Syntax :MEASure:VSTArt?

The :MEASure:VSTArt? query returns the current value of the Y1 cursor.

Return Format <value><NL>
 <value> ::= voltage at voltage marker 1 in NR3 format

- See Also**
- "[Introduction to :MARKer Commands](#)" on page 296
 - "[Introduction to :MEASure Commands](#)" on page 312
 - "[:MARKer:Y1Position](#)" on page 303
 - "[:MARKer:Y2Position](#)" on page 304
 - "[:MARKer:YDELta](#)" on page 305
 - "[:MARKer:X1Y1source](#)" on page 299
 - "[:MEASure:SOURce](#)" on page 337
 - "[:MEASure:TDELta](#)" on page 715
 - "[:MEASure:TSTArt](#)" on page 719

:MEASure:VSTOp

O (see [page 786](#))

Command Syntax :MEASure:VSTOp <vstop_argument>
 <vstop_argument> ::= value for Y2 cursor

The :MEASure:VSTOp command moves the vertical marker 2 (Y2 cursor) to the specified value corresponding to the selected source. The source can be selected by the MARKer:X2Y2source command.

NOTE

The short form of this command, VSTO, does not follow the defined Long Form to Short Form Truncation Rules (see [page 788](#)). The normal short form, VST, would be the same for both VSTArt and VSTOp, so sending VST for the VSTOp command produces an error.

NOTE

The :MEASure:VSTOp command is an obsolete command provided for compatibility to previous oscilloscopes. Use the :MARKer:Y2Position command (see [page 304](#)) instead.

Query Syntax :MEASure:VSTOp?

The :MEASure:VSTOp? query returns the current value of the Y2 cursor.

Return Format <value><NL>
 <value> ::= value of the Y2 cursor in NR3 format

- See Also**
- "[Introduction to :MARKer Commands](#)" on page 296
 - "[Introduction to :MEASure Commands](#)" on page 312
 - "[:MARKer:Y1Position](#)" on page 303
 - "[:MARKer:Y2Position](#)" on page 304
 - "[:MARKer:YDELta](#)" on page 305
 - "[:MARKer:X2Y2source](#)" on page 301
 - "[:MEASure:SOURce](#)" on page 337
 - "[:MEASure:TDELta](#)" on page 715
 - "[:MEASure:TSTArt](#)" on page 719

:MTESt:AMASk:{SAVE | STORe}

O (see [page 786](#))

Command Syntax :MTESt:AMASk:{SAVE | STORe} "<filename>"

The :MTESt:AMASk:SAVE command saves the automask generated mask to a file. If an automask has not been generated, an error occurs.

The <filename> parameter is an MS-DOS compatible name of the file, a maximum of 254 characters long (including the path name, if used). The filename assumes the present working directory if a path does not precede the file name.

NOTE

The :MTESt:AMASk:{SAVE | STORe} command is obsolete and is provided for backward compatibility to previous oscilloscopes. Use the :SAVE:MASK[:STARt] command (see [page 413](#)) instead.

See Also • "Introduction to :MTESt Commands" on page 360

:MTESt:AVERage

O (see [page 786](#))

Command Syntax :MTESt:AVERage <on_off>
<on_off> ::= {{1 | ON} | {0 | OFF}}

The :MTESt:AVERage command enables or disables averaging. When ON, the oscilloscope acquires multiple data values for each time bucket, and averages them. When OFF, averaging is disabled. To set the number of averages, use the :MTESt:AVERage:COUNT command described next.

NOTE

The :MTESt:AVERage command is obsolete and is provided for backward compatibility to previous oscilloscopes. Use the :ACQUIRE:TYPE AVERage command (see [page 196](#)) instead.

Query Syntax :MTESt:AVERage?

The :MTESt:AVERage? query returns the current setting for averaging.

Return Format <on_off><NL>
<on_off> ::= {1 | 0}

- See Also**
- "[Introduction to :MTESt Commands](#)" on page 360
 - "[:MTESt:AVERage:COUNT](#)" on page 729

:MTESt:AVERAge:COUNT

O (see [page 786](#))

Command Syntax :MTESt:AVERAge:COUNT <count>
 <count> ::= an integer from 2 to 65536 in NR1 format

The :MTESt:AVERAge:COUNT command sets the number of averages for the waveforms. With the AVERAge acquisition type, the :MTESt:AVERAge:COUNT command specifies the number of data values to be averaged for each time bucket before the acquisition is considered complete for that time bucket.

NOTE The :MTESt:AVERAge:COUNT command is obsolete and is provided for backward compatibility to previous oscilloscopes. Use the :ACQuire:COUNT command (see [page 185](#)) instead.

Query Syntax :MTESt:AVERAge:COUNT?
 The :MTESt:AVERAge:COUNT? query returns the currently selected count value.

Return Format <count><NL>
 <count> ::= an integer from 2 to 65536 in NR1 format

- See Also**
- "Introduction to :MTESt Commands" on page 360
 - ":MTESt:AVERAge" on page 728

:MTEST:LOAD

O (see [page 786](#))

Command Syntax :MTEST:LOAD "<filename>"

The :MTEST:LOAD command loads the specified mask file.

The <filename> parameter is an MS-DOS compatible name of the file, a maximum of 254 characters long (including the path name, if used).

NOTE

The :MTEST:LOAD command is obsolete and is provided for backward compatibility to previous oscilloscopes. Use the :RECall:MASK[:START] command (see [page 400](#)) instead.

- See Also**
- "Introduction to :MTEST Commands" on page 360
 - ":MTEST:AMASK:{SAVE | STORE}" on page 727

:MTEST:RUMode

O (see [page 786](#))

Command Syntax :MTEST:RUMode {FORever | TIME,<seconds> | {WAVeforms,<wfm_count>}}

<seconds> ::= from 1 to 86400 in NR3 format

<wfm_count> ::= number of waveforms in NR1 format
from 1 to 1,000,000,000

The :MTEST:RUMode command determines the termination conditions for the mask test. The choices are FORever, TIME, or WAVeforms.

- FORever – runs the Mask Test until the test is turned off.
- TIME – sets the amount of time in seconds that a mask test will run before it terminates. The <seconds> parameter is a real number from 1 to 86400 seconds.
- WAVeforms – sets the maximum number of waveforms that are required before the mask test terminates. The <wfm_count> parameter indicates the number of waveforms that are to be acquired; it is an integer from 1 to 1,000,000,000.

NOTE

The :MTEST:RUMode command is obsolete and is provided for backward compatibility to previous oscilloscopes. Use the :MTEST:RMODE command (see [page 377](#)) instead.

Query Syntax :MTEST:RUMode?

The :MTEST:RUMode? query returns the currently selected termination condition and value.

Return Format {FOR | TIME,<seconds> | {WAV,<wfm_count>}}<NL>

<seconds> ::= from 1 to 86400 in NR3 format

<wfm_count> ::= number of waveforms in NR1 format
from 1 to 1,000,000,000

- See Also**
- ["Introduction to :MTEST Commands"](#) on page 360
 - [":MTEST:RUMode:SOFailure"](#) on page 732

:MTESt:RUMode:SOFailure

O (see [page 786](#))

Command Syntax :MTESt:RUMode:SOFailure <on_off>
<on_off> ::= {{1 | ON} | {0 | OFF}}

The :MTESt:RUMode:SOFailure command enables or disables the Stop On Failure run until criteria. When a mask test is run and a mask violation is detected, the mask test is stopped and the acquisition system is stopped.

NOTE

The :MTESt:RUMode:SOFailure command is obsolete and is provided for backward compatibility to previous oscilloscopes. Use the :MTESt:RMODE:FACTion:STOP command (see [page 381](#)) instead.

Query Syntax :MTESt:RUMode:SOFailure?

The :MTESt:RUMode:SOFailure? query returns the current state of the Stop on Failure control.

Return Format <on_off><NL>
<on_off> ::= {1 | 0}

- See Also**
- "[Introduction to :MTESt Commands](#)" on page 360
 - "[:MTESt:RUMode](#)" on page 731

:MTEST:{START | STOP}

O (see [page 786](#))

Command Syntax :MTEST:{START | STOP}

The :MTEST:{START | STOP} command starts or stops the acquisition system.

NOTE

The :MTEST:START and :MTEST:STOP commands are obsolete and are provided for backward compatibility to previous oscilloscopes. Use the :RUN command (see [page 174](#)) and :STOP command (see [page 178](#)) instead.

See Also • "Introduction to :MTEST Commands" on page 360

:MTESt:TRIGger:SOURce

O (see [page 786](#))

Command Syntax :MTESt:TRIGger:SOURce <source>

<source> ::= CHANnel<n>

<n> ::= {1 | 2 | 3 | 4} for the four channel oscilloscope models

<n> ::= {1 | 2} for the two channel oscilloscope models

The :MTESt:TRIGger:SOURce command sets the channel to use as the trigger.

NOTE

The :MTESt:TRIGger:SOURce command is obsolete and is provided for backward compatibility to previous oscilloscopes. Use the trigger source commands (see [page 467](#)) instead.

Query Syntax :MTESt:TRIGger:SOURce?

The :MTESt:TRIGger:SOURce? query returns the currently selected trigger source.

Return Format <source> ::= CHAN<n>

<n> ::= {1 | 2 | 3 | 4} for the four channel oscilloscope models

<n> ::= {1 | 2} for the two channel oscilloscope models

See Also • ["Introduction to :MTESt Commands"](#) on page 360

:PRINt?

O (see [page 786](#))

Query Syntax

:PRINt? [<options>]

<options> ::= [<print option>][,...,<print option>]

<print option> ::= {COLor | GRAYscale | BMP8bit | BMP}

The :PRINt? query pulls image data back over the bus for storage.

NOTE

The :PRINT command is an obsolete command provided for compatibility to previous oscilloscopes. Use the :DISPlay:DATA command (see [page 247](#)) instead.

Print Option	:PRINt command	:PRINt? query	Query Default
COLor	Sets palette=COLor		
GRAYscale	Sets palette=GRAYscale		palette=COLor
PRINter0,1	Causes the USB printer #0,1 to be selected as destination (if connected)	Not used	N/A
BMP8bit	Sets print format to 8-bit BMP	Selects 8-bit BMP formatting for query	N/A
BMP	Sets print format to BMP	Selects BMP formatting for query	N/A
FACTors	Selects outputting of additional settings information for :PRINT	Not used	N/A
NOFactors	Deselects outputting of additional settings information for :PRINT	Not used	N/A

Old Print Option:	Is Now:
HIRes	COLor
LORes	GRAYscale
PARallel	PRINter0

7 Obsolete and Discontinued Commands

Old Print Option:	Is Now:
DISK	invalid
PCL	invalid

NOTE

The PRINT? query is not a core command.

- See Also**
- ["Introduction to Root \(: \) Commands"](#) on page 141
 - ["Introduction to :HARDcopy Commands"](#) on page 282
 - [":HARDcopy:FORMat"](#) on page 709
 - [":HARDcopy:FACTors"](#) on page 285
 - [":HARDcopy:GRAYscale"](#) on page 710
 - [":DISPlay:DATA"](#) on page 247

:TIMEbase:DElay

O (see [page 786](#))

Command Syntax :TIMEbase:DElay <delay_value>

<delay_value> ::= time in seconds from trigger to the delay reference point on the screen.

The valid range for delay settings depends on the time/division setting for the main time base.

The :TIMEbase:DElay command sets the main time base delay. This delay is the time between the trigger event and the delay reference point on the screen. The delay reference point is set with the :TIMEbase:REFerence command (see [page 461](#)).

NOTE

The :TIMEbase:DElay command is obsolete and is provided for backward compatibility to previous oscilloscopes. Use the :TIMEbase:POSition command (see [page 458](#)) instead.

Query Syntax :TIMEbase:DElay?

The :TIMEbase:DElay query returns the current delay value.

Return Format <delay_value><NL>

<delay_value> ::= time from trigger to display reference in seconds in NR3 format.

Example Code

```
' TIMEBASE_DELAY - Sets the time base delay. This delay
' is the internal time between the trigger event and the
' onscreen delay reference point.

' Set time base delay to 0.0.
myScope.WriteString ":TIMEBASE:DELAY 0.0"
```

Example program from the start: "[VISA COM Example in Visual Basic](#)" on [page 812](#)

:TRIGger:CAN:ACKnowledge

O (see [page 786](#))

Command Syntax :TRIGger:CAN:ACKnowledge <value>
<value> ::= {0 | OFF}

This command was used with the N2758A CAN trigger module for 54620/54640 Series mixed-signal oscilloscopes. The InfiniiVision 7000 Series oscilloscopes do not support the N2758A CAN trigger module.

Query Syntax :TRIGger:CAN:ACKnowledge?

The :TRIGger:CAN:ACKnowledge? query returns the current CAN acknowledge setting.

Return Format <value><NL>

<value> ::= 0

- See Also**
- "[Introduction to :TRIGger Commands](#)" on page 467
 - "[:TRIGger:MODE](#)" on page 473
 - "[:TRIGger:CAN:TRIGger](#)" on page 487

:TRIGger:CAN:SIGNA:l:DEFinition

O (see [page 786](#))

Command Syntax :TRIGger:CAN:SIGNA:l:DEFinition <value>

<value> ::= {CANH | CANL | RX | TX | DIFFerential}

The :TRIGger:CAN:SIGNA:l:DEFinition command sets the CAN signal type when :TRIGger:CAN:TRIGger is set to SOF (start of frame). These signals can be set to:

Dominant high signal:

- CANH – the actual CAN_H differential bus signal.

Dominant low signals:

- CANL – the actual CAN_L differential bus signal.
- RX – the Receive signal from the CAN bus transceiver.
- TX – the Transmit signal to the CAN bus transceiver.
- DIFFerential – the CAN differential bus signal connected to an analog source channel using a differential probe.

NOTE

With InfiniiVision 7000 Series oscilloscope software version 5.00 or greater, this command is available, but the only legal value is DIFF.

Query Syntax :TRIGger:CAN:SIGNA:l:DEFinition?

The :TRIGger:CAN:SIGNA:l:DEFinition? query returns the current CAN signal type.

Return Format <value><NL>

<value> ::= DIFF

- See Also**
- ["Introduction to :TRIGger Commands"](#) on page 467
 - [":TRIGger:MODE"](#) on page 473
 - [":TRIGger:CAN:SIGNA:l:BAUDrate"](#) on page 485
 - [":TRIGger:CAN:SOURce"](#) on page 486
 - [":TRIGger:CAN:TRIGger"](#) on page 487

:TRIGger:LIN:SIGNal:DEFinition

O (see [page 786](#))

Command Syntax :TRIGger:LIN:SIGNal:DEFinition <value>
<value> ::= {LIN | RX | TX}

The :TRIGger:LIN:SIGNal:DEFinition command sets the LIN signal type. These signals can be set to:

Dominant low signals:

- LIN – the actual LIN single-end bus signal line.
- RX – the Receive signal from the LIN bus transceiver.
- TX – the Transmit signal to the LIN bus transceiver.

NOTE

With InfiniiVision 7000 Series oscilloscope software version 5.00 or greater, this command is available, but the only legal value is LIN.

Query Syntax :TRIGger:LIN:SIGNal:DEFinition?

The :TRIGger:LIN:SIGNal:DEFinition? query returns the current LIN signal type.

Return Format <value><NL>
<value> ::= LIN

- See Also**
- ["Introduction to :TRIGger Commands"](#) on page 467
 - [":TRIGger:MODE"](#) on page 473
 - [":TRIGger:LIN:SIGNal:BAUDrate"](#) on page 561
 - [":TRIGger:LIN:SOURce"](#) on page 562

:TRIGger:THReshold

O (see [page 786](#))

Command Syntax :TRIGger:THReshold <channel group>, <threshold type> [, <value>]
 <channel group> ::= {POD1 | POD2}
 <threshold type> ::= {CMOS | ECL | TTL | USERdef}
 <value> ::= voltage for USERdef (floating-point number) [Volt type]
 [Volt type] ::= {V | mV | uV}

The :TRIGger:THReshold command sets the threshold (trigger level) for a pod of 8 digital channels (either digital channels 0 through 7 or 8 through 15). The threshold can be set to a predefined value or to a user-defined value. For the predefined value, the voltage parameter is not required.

NOTE This command is only available on the MSO models.

NOTE The :TRIGger:THReshold command is an obsolete command provided for compatibility to previous oscilloscopes. Use the :POD<n>:THReshold command (see [page 395](#)), :DIGital<n>:THReshold command (see [page 243](#)), or :TRIGger[:EDGE]:LEVel command (see [page 501](#)) for the InfiniiVision 7000 Series oscilloscopes.

Query Syntax :TRIGger:THReshold? <channel group>

The :TRIGger:THReshold? query returns the voltage and threshold text for analog channel 1 or 2, or POD1 or POD2.

Return Format <threshold type>[, <value>]<NL>
 <threshold type> ::= {CMOS | ECL | TTL | USER}
 CMOS ::= 2.5V
 TTL ::= 1.5V
 ECL ::= -1.3V
 USERdef ::= range from -8.0V to +8.0V.
 <value> ::= voltage for USERdef (a floating-point number in NR1).

:TRIGger:TV:TVMode

O (see [page 786](#))

Command Syntax :TRIGger:TV:TVMode <mode>

```
<mode> ::= {FIEld1 | FIEld2 | AFIElds | ALINes | LINE | VERTical
           | LFIeld1 | LFIeld2 | LALTernate | LVERTical}
```

The :TRIGger:TV:MODE command selects the TV trigger mode and field. The LVERTical parameter is only available when :TRIGger:TV:STANdard is GENERic. The LALTernate parameter is not available when :TRIGger:TV:STANdard is GENERic (see [page 595](#)).

Old forms for <mode> are accepted:

<mode>	Old Forms Accepted
FIEld1	F1
FIEld2	F2
AFIEld	ALLFields, ALLFLDS
ALINes	ALLLines
LFIeld1	LINEF1, LINEFIELD1
LFIeld2	LINEF2, LINEFIELD2
LALTernate	LINEAlt
LVERTical	LINEVert

NOTE

The :TRIGger:TV:TVMode command is an obsolete command provided for compatibility to previous oscilloscopes. Use the :TRIGger:TV:MODE command (see [page 592](#)) instead.

Query Syntax :TRIGger:TV:TVMode?

The :TRIGger:TV:TVMode? query returns the TV trigger mode.

Return Format <value><NL>

```
<value> ::= {FIE1 | FIE2 | AFI | ALIN | LINE | VERT | LFI1 | LFI2
           | LALT | LVER}
```

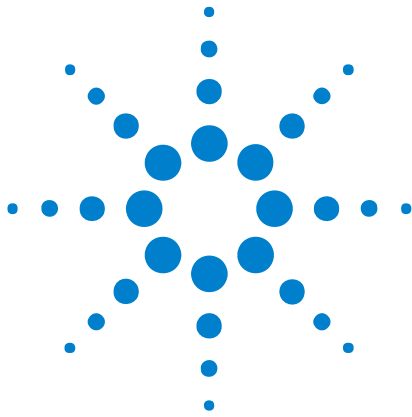

8 Error Messages

-440, Query UNTERMINATED after indefinite response

-430, Query DEADLOCKED

-420, Query UNTERMINATED

-410, Query INTERRUPTED

-400, Query error

-340, Calibration failed

-330, Self-test failed

-321, Out of memory

-320, Storage fault

-315, Configuration memory lost



-314, Save/recall memory lost

-313, Calibration memory lost

-311, Memory error

-310, System error

-300, Device specific error

-278, Macro header not found

-277, Macro redefinition not allowed

-276, Macro recursion error

-273, Illegal macro label

-272, Macro execution error

-258, Media protected

-257, File name error

-256, File name not found

-255, Directory full

-254, Media full

-253, Corrupt media

-252, Missing media

-251, Missing mass storage

-250, Mass storage error

-241, Hardware missing

This message can occur when a feature is unavailable or unlicensed.

For example, serial bus decode commands (which require a four-channel oscilloscope) are unavailable on two-channel oscilloscopes, and some serial bus decode commands are only available on four-channel oscilloscopes when the AMS (automotive serial decode) or LSS (low-speed serial decode) options are licensed.

-240, Hardware error

-231, Data questionable

-230, Data corrupt or stale

-224, Illegal parameter value

-223, Too much data

-222, Data out of range

-221, Settings conflict

-220, Parameter error

-200, Execution error

-183, Invalid inside macro definition

-181, Invalid outside macro definition

-178, Expression data not allowed

-171, Invalid expression

-170, Expression error

-168, Block data not allowed

-161, Invalid block data

-158, String data not allowed

-151, Invalid string data

-150, String data error

-148, Character data not allowed

-138, Suffix not allowed

-134, Suffix too long

-131, Invalid suffix

-128, Numeric data not allowed

-124, Too many digits

-123, Exponent too large

-121, Invalid character in number

-120, Numeric data error

-114, Header suffix out of range

-113, Undefined header

-112, Program mnemonic too long

-109, Missing parameter

-108, Parameter not allowed

-105, GET not allowed

-104, Data type error

-103, Invalid separator

-102, Syntax error

-101, Invalid character

-100, Command error

+10, Software Fault Occurred

+100, File Exists

+101, End-Of-File Found

+102, Read Error

+103, Write Error**+104, Illegal Operation****+105, Print Canceled****+106, Print Initialization Failed****+107, Invalid Trace File****+108, Compression Error****+109, No Data For Operation**

A remote operation wants some information, but there is no information available. For example, you may request a stored TIFF image using the :DISPlay:DATA? query, but there may be no image stored.

+112, Unknown File Type**+113, Directory Not Supported**

8 Error Messages

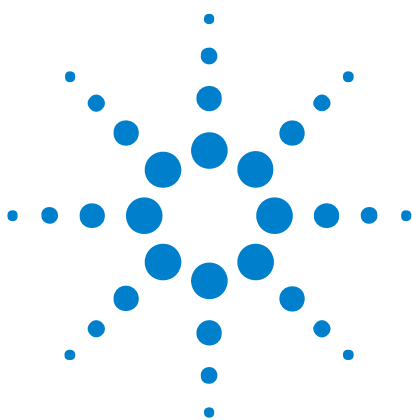

9 Status Reporting

Status Reporting Data Structures	754
Status Byte Register (STB)	757
Service Request Enable Register (SRE)	759
Trigger Event Register (TER)	760
Output Queue	761
Message Queue	762
(Standard) Event Status Register (ESR)	763
(Standard) Event Status Enable Register (ESE)	764
Error Queue	765
Operation Status Event Register (:OPERRegister[:EVENTt])	766
Operation Status Condition Register (:OPERRegister:CONDition)	767
Arm Event Register (AER)	768
Overload Event Register (:OVLRegister)	769
Hardware Event Event Register (:HWERegister[:EVENTt])	770
Hardware Event Condition Register (:HWERegister:CONDition)	771
Mask Test Event Event Register (:MTERegister[:EVENTt])	772
Clearing Registers and Queues	773
Status Reporting Decision Chart	774

IEEE 488.2 defines data structures, commands, and common bit definitions for status reporting (for example, the Status Byte Register and the Standard Event Status Register). There are also instrument-defined structures and bits (for example, the Operation Status Event Register and the Overload Event Register).

An overview of the oscilloscope's status reporting structure is shown in the following block diagram. The status reporting structure allows monitoring specified events in the oscilloscope. The ability to monitor and report these events allows determination of such things as the status of an operation, the availability and reliability of the measured data, and more.



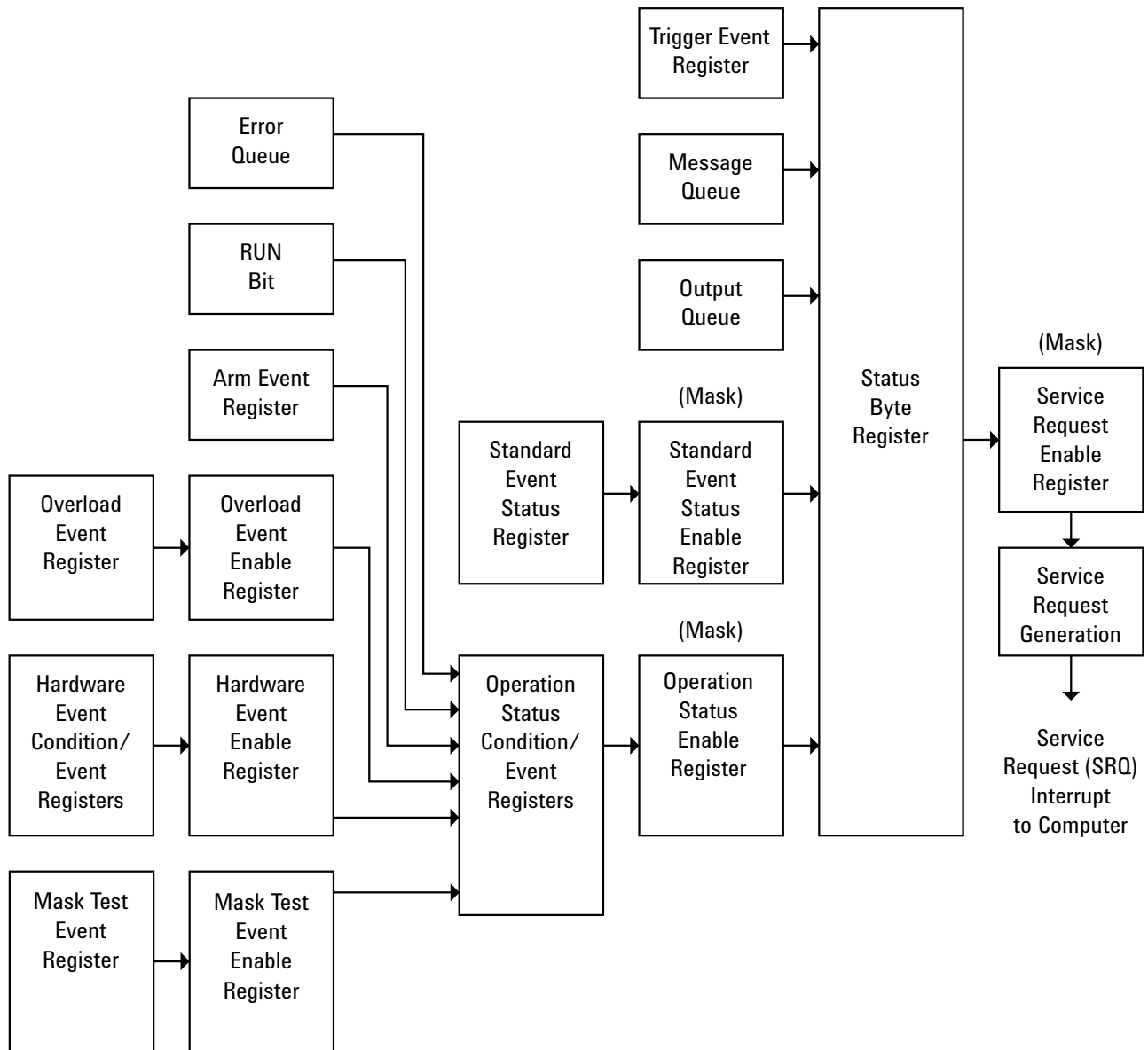

- To monitor an event, first clear the event; then, enable the event. All of the events are cleared when you initialize the instrument.
- To allow a service request (SRQ) interrupt to an external controller, enable at least one bit in the Status Byte Register (by setting, or unmasking, the bit in the Service Request Enable register).

The Status Byte Register, the Standard Event Status Register group, and the Output Queue are defined as the Standard Status Data Structure Model in IEEE 488.2-1987.

The bits in the status byte act as summary bits for the data structures residing behind them. In the case of queues, the summary bit is set if the queue is not empty. For registers, the summary bit is set if any enabled bit in the event register is set. The events are enabled with the corresponding event enable register. Events captured by an event register remain set until the register is read or cleared. Registers are read with their associated commands. The *CLS command clears all event registers and all queues except the output queue. If you send *CLS immediately after a program message terminator, the output queue is also cleared.

Status Reporting Data Structures

The following figure shows how the status register bits are masked and logically OR'ed to generate service requests (SRQ) on particular events.

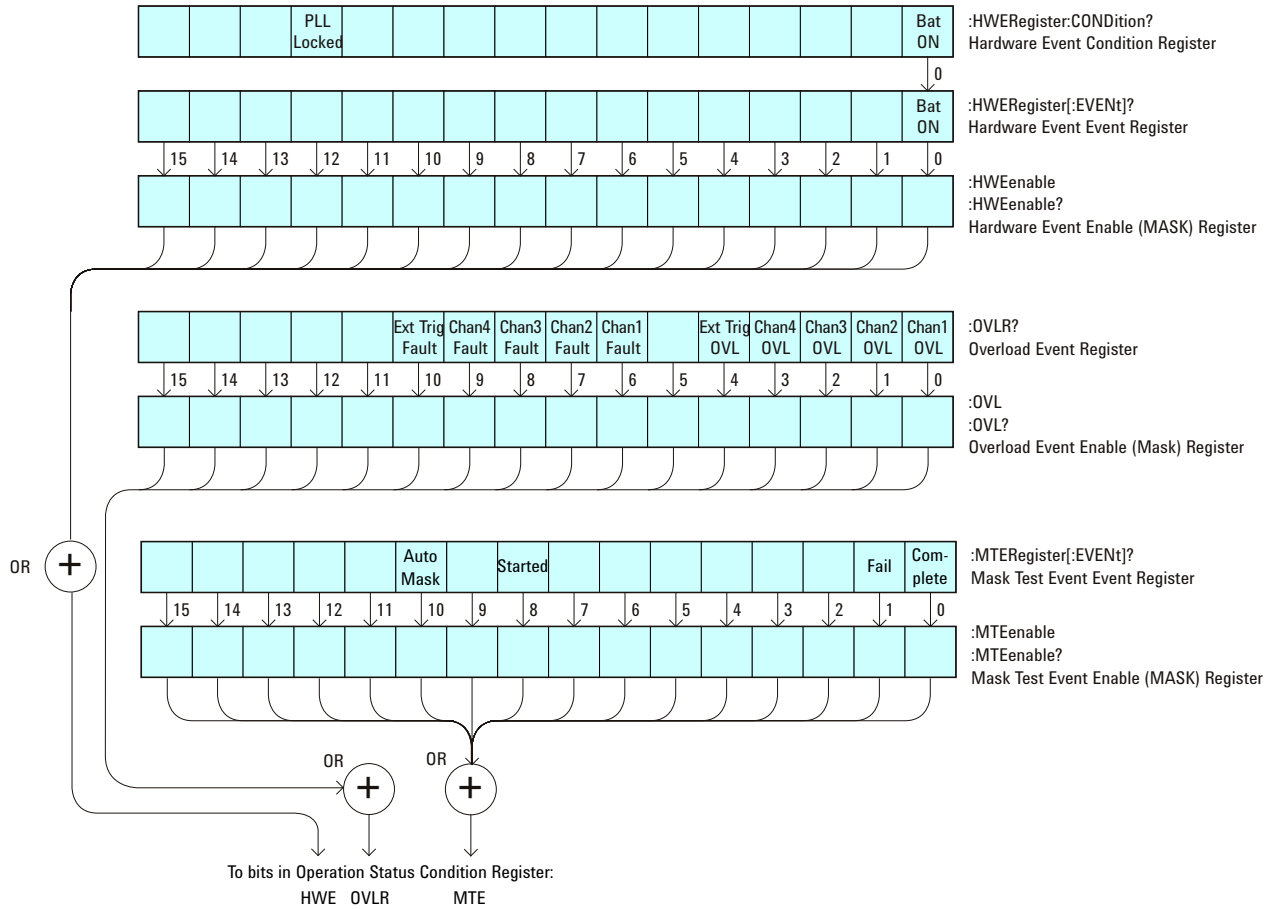

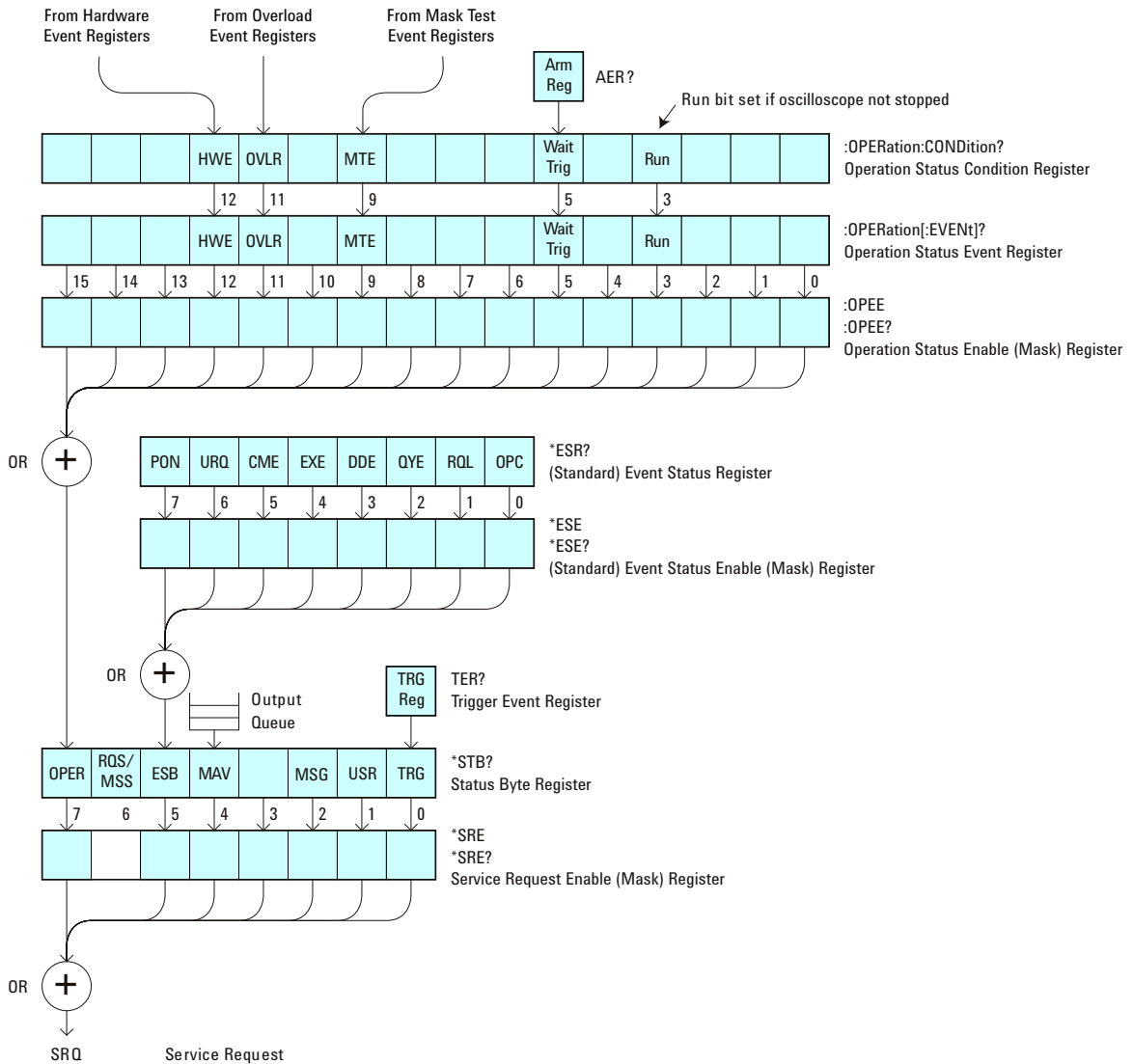

The status register bits are described in more detail in the following tables:

- [Table 44](#)
- [Table 42](#)
- [Table 52](#)
- [Table 53](#)
- [Table 55](#)
- [Table 47](#)
- [Table 48](#)
- [Table 50](#)

The status registers picture above shows how the different status reporting data structures work together. To make it possible for any of the Standard Event Status Register bits to generate a summary bit, the bits must be enabled. These bits are enabled by using the *ESE common command to set the corresponding bit in the Standard Event Status Enable Register.

To generate a service request (SRQ) interrupt to an external controller, at least one bit in the Status Byte Register must be enabled. These bits are enabled by using the *SRE common command to set the corresponding bit in the Service Request Enable Register. These enabled bits can then set RQS and MSS (bit 6) in the Status Byte Register.

Status Byte Register (STB)

The Status Byte Register is the summary-level register in the status reporting structure. It contains summary bits that monitor activity in the other status registers and queues. The Status Byte Register is a live register. That is, its summary bits are set and cleared by the presence and absence of a summary bit from other event registers or queues.

If the Status Byte Register is to be used with the Service Request Enable Register to set bit 6 (RQS/MSS) and to generate an SRQ, at least one of the summary bits must be enabled, then set. Also, event bits in all other status registers must be specifically enabled to generate the summary bit that sets the associated summary bit in the Status Byte Register.

The Status Byte Register can be read using either the *STB? Common Command or the programming interface serial poll command. Both commands return the decimal-weighted sum of all set bits in the register. The difference between the two methods is that the serial poll command reads bit 6 as the Request Service (RQS) bit and clears the bit which clears the SRQ interrupt. The *STB? command reads bit 6 as the Master Summary Status (MSS) and does not clear the bit or have any affect on the SRQ interrupt. The value returned is the total bit weights of all of the bits that are set at the present time.

The use of bit 6 can be confusing. This bit was defined to cover all possible computer interfaces, including a computer that could not do a serial poll. The important point to remember is that, if you are using an SRQ interrupt to an external computer, the serial poll command clears bit 6. Clearing bit 6 allows the oscilloscope to generate another SRQ interrupt when another enabled event occurs.

No other bits in the Status Byte Register are cleared by either the *STB? query or the serial poll, except the Message Available bit (bit 4). If there are no other messages in the Output Queue, bit 4 (MAV) can be cleared as a result of reading the response to the *STB? command.

If bit 4 (weight = 16) and bit 5 (weight = 32) are set, the program prints the sum of the two weights. Since these bits were not enabled to generate an SRQ, bit 6 (weight = 64) is not set.

The following example uses the *STB? query to read the contents of the oscilloscope's Status Byte Register.

```
myScope.WriteString "*STB?"
varQueryResult = myScope.ReadNumber
MsgBox "Status Byte Register, Read: 0x" + Hex(varQueryResult)
```

The next program prints 0xD1 and clears bit 6 (RQS) and bit 4 (MAV) of the Status Byte Register. The difference in the output value between this example and the previous one is the value of bit 6 (weight = 64). Bit 6 is set when the first enabled summary bit is set and is cleared when the Status Byte Register is read by the serial poll command.

Example The following example uses the resource session object's ReadSTB method to read the contents of the oscilloscope's Status Byte Register.

```
varQueryResult = myScope.IO.ReadSTB
MsgBox "Status Byte Register, Serial Poll: 0x" + Hex(varQueryResult)
```

NOTE

Use Serial Polling to Read Status Byte Register. Serial polling is the preferred method to read the contents of the Status Byte Register because it resets bit 6 and allows the next enabled event that occurs to generate a new SRQ interrupt.

Service Request Enable Register (SRE)

Setting the Service Request Enable Register bits enable corresponding bits in the Status Byte Register. These enabled bits can then set RQS and MSS (bit 6) in the Status Byte Register.

Bits are set in the Service Request Enable Register using the *SRE command and the bits that are set are read with the *SRE? query.

Example The following example sets bit 4 (MAV) and bit 5 (ESB) in the Service Request Enable Register.

```
myScope.WriteString "*SRE " + CStr(CInt("&H30"))
```

This example uses the decimal parameter value of 48, the string returned by CStr(CInt("&H30")), to enable the oscilloscope to generate an SRQ interrupt under the following conditions:

- When one or more bytes in the Output Queue set bit 4 (MAV).
- When an enabled event in the Standard Event Status Register generates a summary bit that sets bit 5 (ESB).

Trigger Event Register (TER)

This register sets the TRG bit in the status byte when a trigger event occurs.

The TER event register stays set until it is cleared by reading the register or using the *CLS command. If your application needs to detect multiple triggers, the TER event register must be cleared after each one.

If you are using the Service Request to interrupt a program or controller operation, you must clear the event register each time the trigger bit is set.

Output Queue

The output queue stores the oscilloscope-to-controller responses that are generated by certain instrument commands and queries. The output queue generates the Message Available summary bit when the output queue contains one or more bytes. This summary bit sets the MAV bit (bit 4) in the Status Byte Register.

When using the Agilent VISA COM library, the output queue may be read with the FormattedIO488 object's ReadString, ReadNumber, ReadList, or ReadIEEEBlock methods.

Message Queue

The message queue contains the text of the last message written to the advisory line on the screen of the oscilloscope. The length of the oscilloscope's message queue is 1. Note that messages sent with the :SYSTem:DSP command do not set the MSG status bit in the Status Byte Register.

(Standard) Event Status Register (ESR)

The (Standard) Event Status Register (ESR) monitors the following oscilloscope status events:

- PON - Power On
- URQ - User Request
- CME - Command Error
- EXE - Execution Error
- DDE - Device Dependent Error
- QYE - Query Error
- RQC - Request Control
- OPC - Operation Complete

When one of these events occur, the event sets the corresponding bit in the register. If the bits are enabled in the Standard Event Status Enable Register, the bits set in this register generate a summary bit to set bit 5 (ESB) in the Status Byte Register.

You can read the contents of the Standard Event Status Register and clear the register by sending the *ESR? query. The value returned is the total bit weights of all of the bits that are set at the present time.

Example The following example uses the *ESR query to read the contents of the Standard Event Status Register.

```
myScope.WriteString "*ESR?"
varQueryResult = myScope.ReadNumber
MsgBox "Standard Event Status Register: 0x" + Hex(varQueryResult)
```

If bit 4 (weight = 16) and bit 5 (weight = 32) are set, the program prints the sum of the two weights.

(Standard) Event Status Enable Register (ESE)

To allow any of the (Standard) Event Status Register (ESR) bits to generate a summary bit, you must first enable that bit. Enable the bit by using the *ESE (Event Status Enable) common command to set the corresponding bit in the (Standard) Event Status Enable Register (ESE).

Set bits are read with the *ESE? query.

Example Suppose your application requires an interrupt whenever any type of error occurs. The error related bits in the (Standard) Event Status Register are bits 2 through 5 (hexadecimal value 0x3C). Therefore, you can enable any of these bits to generate the summary bit by sending:

```
myScope.WriteString "*ESE " + CStr(CInt("&H3C"))
```

Whenever an error occurs, it sets one of these bits in the (Standard) Event Status Register. Because all the error related bits are enabled, a summary bit is generated to set bit 5 (ESB) in the Status Byte Register.

If bit 5 (ESB) in the Status Byte Register is enabled (via the *SRE command), an SRQ service request interrupt is sent to the controller PC.

NOTE

Disabled (Standard) Event Status Register bits respond but do not generate a summary bit. (Standard) Event Status Register bits that are not enabled still respond to their corresponding conditions (that is, they are set if the corresponding event occurs). However, because they are not enabled, they do not generate a summary bit to the Status Byte Register.

Error Queue

As errors are detected, they are placed in an error queue. This queue is first in, first out. If the error queue overflows, the last error in the queue is replaced with error 350, Queue overflow. Any time the queue overflows, the least recent errors remain in the queue, and the most recent error is discarded. The length of the oscilloscope's error queue is 30 (29 positions for the error messages, and 1 position for the Queue overflow message).

The error queue is read with the `:SYSTEM:ERROR?` query. Executing this query reads and removes the oldest error from the head of the queue, which opens a position at the tail of the queue for a new error. When all the errors have been read from the queue, subsequent error queries return "0, No error".

The error queue is cleared when:

- the instrument is powered up,
- the instrument receives the `*CLS` common command, or
- the last item is read from the error queue.

Operation Status Event Register (:OPERRegister[:EVENTt])

The Operation Status Event Register register hosts these bits:

Name	Location	Description
RUN bit	bit 3	Is set whenever the instrument goes from a stop state to a single or running state.
WAIT TRIG bit	bit 5	Is set by the Trigger Armed Event Register and indicates that the trigger is armed.
MTE bit	bit 9	Comes from the Mask Test Event Registers.
OVLN bit	bit 11	Is set whenever a 50Ω input overload occurs.
HWE bit	bit 12	Comes from the Hardware Event Registers.

If any of these bits are set, the OPER bit (bit 7) of the Status Byte Register is set. The Operation Status Event Register is read and cleared with the :OPERRegister[:EVENTt]? query. The register output is enabled or disabled using the mask value supplied with the OPEE command.

Operation Status Condition Register (:OPERRegister:CONDition)

The Operation Status Condition Register register hosts these bits:

Name	Location	Description
RUN bit	bit 3	Is set whenever the instrument is not stopped.
WAIT TRIG bit	bit 5	Is set by the Trigger Armed Event Register and indicates that the trigger is armed.
MTE bit	bit 9	Comes from the Mask Test Event Registers.
OVLRL bit	bit 11	Is set whenever a 50Ω input overload occurs.
HWE bit	bit 12	Comes from the Hardware Event Registers.

The :OPERRegister:CONDition? query returns the value of the Operation Status Condition Register.

Arm Event Register (AER)

This register sets bit 5 (Wait Trig bit) in the Operation Status Register and the OPER bit (bit 7) in the Status Byte Register when the instrument becomes armed.

The ARM event register stays set until it is cleared by reading the register with the AER? query or using the *CLS command. If your application needs to detect multiple triggers, the ARM event register must be cleared after each one.

If you are using the Service Request to interrupt a program or controller operation when the trigger bit is set, then you must clear the event register after each time it has been set.

Overload Event Register (:OVLRegister)

The Overload Event Register register hosts these bits:

Name	Location	Description
Channel 1 OVL	bit 0	Overload has occurred on Channel 1 input.
Channel 2 OVL	bit 1	Overload has occurred on Channel 2 input.
Channel 3 OVL	bit 2	Overload has occurred on Channel 3 input.
Channel 4 OVL	bit 3	Overload has occurred on Channel 4 input.
External Trigger OVL	bit 4	Overload has occurred on External Trigger input.
Channel 1 Fault	bit 6	Fault has occurred on Channel 1 input.
Channel 2 Fault	bit 7	Fault has occurred on Channel 2 input.
Channel 3 Fault	bit 8	Fault has occurred on Channel 3 input.
Channel 4 Fault	bit 9	Fault has occurred on Channel 4 input.
External Trigger Fault	bit 10	Fault has occurred on External Trigger input.

Hardware Event Register (:HWERegister[:EVENT])

This register hosts the Bat On bit (bit 0).

- The Bat On bit is set whenever the instrument is operating on battery power.

Hardware Event Condition Register (:HWERegister:CONDition)

This register hosts the Bat On bit (bit 0) and the PLL LOCKED bit (bit 12).

- The :HWERegister:CONDition? query returns the value of the Hardware Event Condition Register.
- The PLL LOCKED bit (bit 12) is for internal use and is not intended for general use.
- The Bat On bit is set whenever the instrument is operating on battery power.

Mask Test Event Event Register (:MTERegister[:EVENT])

The Mask Test Event Event Register register hosts these bits:

Name	Location	Description
Complete	bit 0	Is set when the mask test is complete.
Fail	bit 1	Is set when there is a mask test failure.
Started	bit 8	Is set when mask testing is started.
Auto Mask	bit 10	Is set when auto mask creation is completed.

The :MTERegister[:EVENT]? query returns the value of, and clears, the Mask Test Event Event Register.

Clearing Registers and Queues

The *CLS common command clears all event registers and all queues except the output queue. If *CLS is sent immediately after a program message terminator, the output queue is also cleared.

Status Reporting Decision Chart

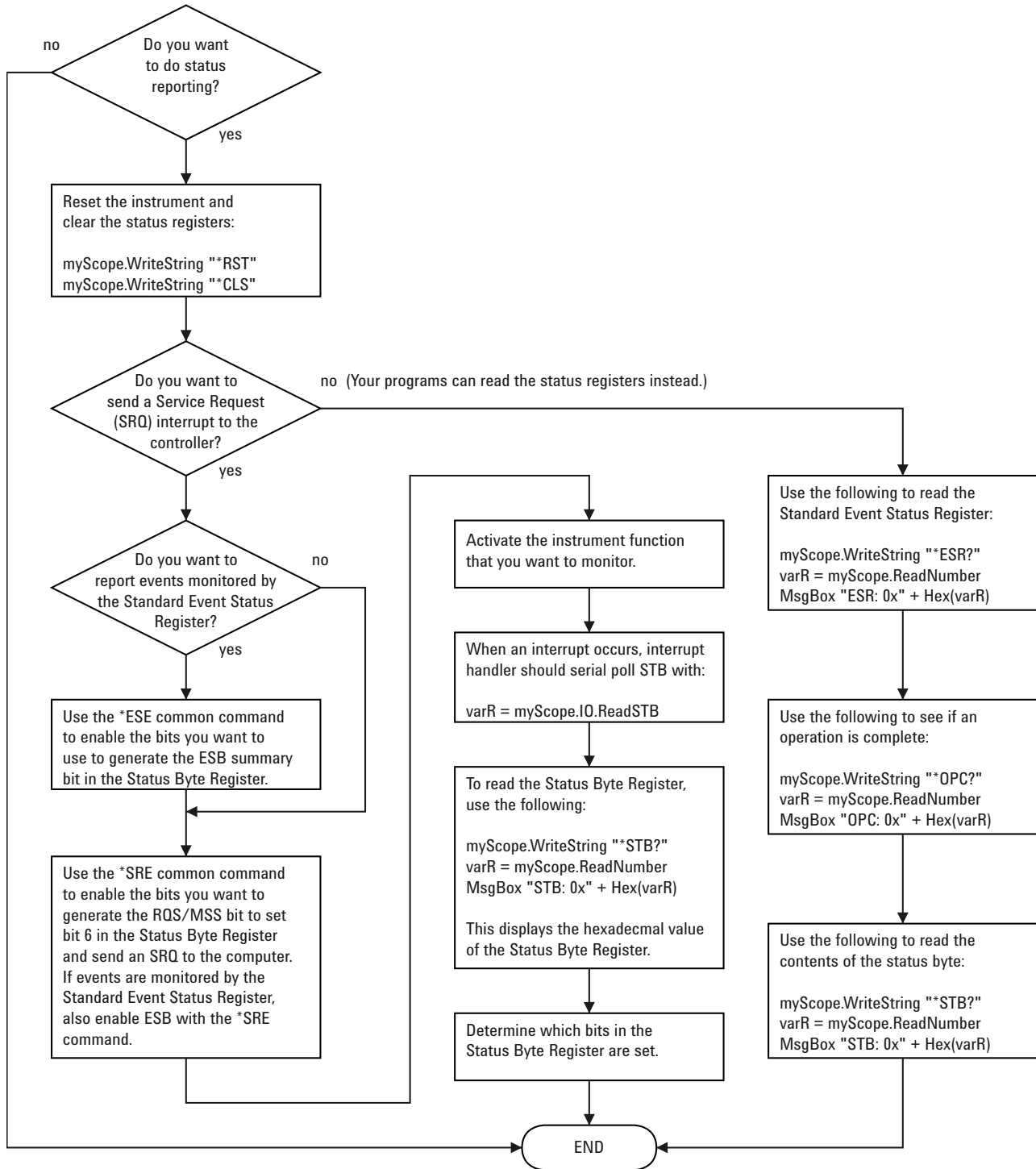

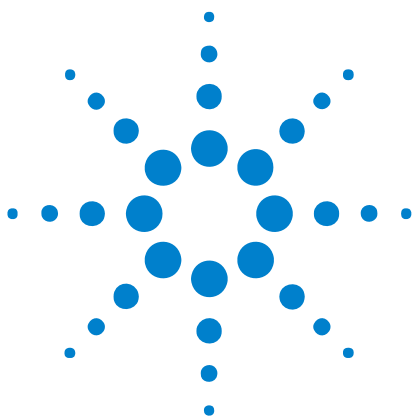

10 Synchronizing Acquisitions

- Synchronization in the Programming Flow [776](#)
- Blocking Synchronization [777](#)
- Polling Synchronization With Timeout [778](#)
- Synchronizing with a Single-Shot Device Under Test (DUT) [780](#)
- Synchronization with an Averaging Acquisition [782](#)

When remotely controlling an oscilloscope with programming commands, it is often necessary to know when the oscilloscope has finished the previous operation and is ready for the next command. The most common example is when an acquisition is started using the `:DIGitize`, `:RUN`, or `:SINGLE` commands. Before a measurement result can be queried, the acquisition must complete. Too often fixed delays are used to accomplish this wait, but fixed delays often use excessive time or the time may not be long enough. A better solution is to use synchronous commands and status to know when the oscilloscope is ready for the next request.



Synchronization in the Programming Flow

Most remote programming follows these three general steps:

- 1 Set up the oscilloscope and device under test (see [page 776](#)).
- 2 Acquire a waveform (see [page 776](#)).
- 3 Retrieve results (see [page 776](#)).

Set Up the Oscilloscope

Before making changes to the oscilloscope setup, it is best to make sure it is stopped using the :STOP command followed by the *OPC? query.

NOTE

It is not necessary to use *OPC?, hard coded waits, or status checking when setting up the oscilloscope. After the oscilloscope is configured, it is ready for an acquisition.

Acquire a Waveform

When acquiring a waveform there are two possible methods used to wait for the acquisition to complete. These methods are blocking and polling. The table below details when each method should be chosen and why.

	Blocking Wait	Polling Wait
Use When	You know the oscilloscope <i>will</i> trigger based on the oscilloscope setup and device under test.	You know the oscilloscope <i>may or may not</i> trigger on the oscilloscope setup and device under test.
Advantages	No need for polling. Fastest method.	Remote interface will not timeout No need for device clear if no trigger.
Disadvantages	Remote interface may timeout. Device clear only way to get control of oscilloscope if there is no trigger.	Slower method. Requires polling loop. Requires known maximum wait time.
Implementation Details	See " Blocking Synchronization " on page 777.	See " Polling Synchronization With Timeout " on page 778.

Retrieve Results

Once the acquisition is complete, it is safe to retrieve measurements and statistics.

Blocking Synchronization

Use the :DIGitize command to start the acquisition. This blocks subsequent queries until the acquisition and processing is complete. For example:

```
'
' Synchronizing acquisition using blocking.
' =====

Option Explicit

Public myMgr As VisaComLib.ResourceManager
Public myScope As VisaComLib.FormattedIO488
Public varQueryResult As Variant
Public strQueryResult As String

Sub Main()

    On Error GoTo VisaComError

    ' Create the VISA COM I/O resource.
    Set myMgr = New VisaComLib.ResourceManager
    Set myScope = New VisaComLib.FormattedIO488
    Set myScope.IO = myMgr.Open("TCPIP0::130.29.69.12::inst0::INSTR")
    myScope.IO.Clear ' Clear the interface.

    ' Set up.
    ' -----
    myScope.WriteString ":TRIGger:MODE EDGE"
    myScope.WriteString ":TRIGger:EDGE:LEVEl 2"
    myScope.WriteString ":TIMEbase:SCALE 5e-8"

    ' Acquire.
    ' -----
    myScope.WriteString ":DIGitize"

    ' Get results.
    ' -----
    myScope.WriteString ":MEASure:RISetime"
    myScope.WriteString ":MEASure:RISetime?"
    varQueryResult = myScope.ReadNumber ' Read risetime.
    Debug.Print "Risetime: " + _
        FormatNumber(varQueryResult * 1000000000, 1) + " ns"

    Exit Sub

VisaComError:
    MsgBox "VISA COM Error:" + vbCrLf + Err.Description

End Sub
```

Polling Synchronization With Timeout

This example requires a timeout value so the operation can abort if an acquisition does not occur within the timeout period:

```
'
' Synchronizing acquisition using polling.
' =====

Option Explicit

Public myMgr As VisaComLib.ResourceManager
Public myScope As VisaComLib.FormattedIO488
Public varQueryResult As Variant
Public strQueryResult As String

Private Declare Sub Sleep Lib "kernel32" (ByVal dwMilliseconds As Long)

Sub Main()

    On Error GoTo VisaComError

    ' Create the VISA COM I/O resource.
    Set myMgr = New VisaComLib.ResourceManager
    Set myScope = New VisaComLib.FormattedIO488
    Set myScope.IO = myMgr.Open("TCPIP0::130.29.69.12::inst0::INSTR")
    myScope.IO.Clear    ' Clear the interface.

    ' Set up.
    ' -----
    ' Set up the trigger and horizontal scale.
    myScope.WriteString ":TRIGger:MODE EDGE"
    myScope.WriteString ":TRIGger:EDGE:LEVel 2"
    myScope.WriteString ":TIMEbase:SCALE 5e-8"

    ' Stop acquisitions and wait for the operation to complete.
    myScope.WriteString ":STOP"
    myScope.WriteString "*OPC?"
    strQueryResult = myScope.ReadString

    ' Acquire.
    ' -----
    ' Start a single acquisition.
    myScope.WriteString ":SINGle"

    ' Oscilloscope is armed and ready, enable DUT here.
    Debug.Print "Oscilloscope is armed and ready, enable DUT."

    ' Look for RUN bit = stopped (acquisition complete).
    Dim lngTimeout As Long    ' Max millisecs to wait for single-shot.
    Dim lngElapsed As Long
    lngTimeout = 10000    ' 10 seconds.
    lngElapsed = 0

    Do While lngElapsed <= lngTimeout
```

```

myScope.WriteString ":OPERRegister:CONDition?"
varQueryResult = myScope.ReadNumber
' Mask RUN bit (bit 3, &H8).
If (varQueryResult And &H8) = 0 Then
    Exit Do
Else
    Sleep 100 ' Small wait to prevent excessive queries.
    lngElapsed = lngElapsed + 100
End If
Loop

' Get results.
' -----
If lngElapsed < lngTimeout Then
    myScope.WriteString ":MEASure:RISetime"
    myScope.WriteString ":MEASure:RISetime?"
    varQueryResult = myScope.ReadNumber ' Read risetime.
    Debug.Print "Risetime: " + _
        FormatNumber(varQueryResult * 1000000000, 1) + " ns"
Else
    Debug.Print "Timeout waiting for single-shot trigger."
End If

Exit Sub

VisaComError:
    MsgBox "VISA COM Error:" + vbCrLf + Err.Description

End Sub

```

Synchronizing with a Single-Shot Device Under Test (DUT)

The examples in ["Blocking Synchronization"](#) on page 777 and ["Polling Synchronization With Timeout"](#) on page 778 assume the DUT is continually running and therefore the oscilloscope will have more than one opportunity to trigger. With a single shot DUT, there is only one opportunity for the oscilloscope to trigger, so it is necessary for the oscilloscope to be armed and ready before the DUT is enabled.

NOTE

The blocking :DIGitize command cannot be used for a single shot DUT because once the :DIGitize command is issued, the oscilloscope is blocked from any further commands until the acquisition is complete.

This example is the same ["Polling Synchronization With Timeout"](#) on page 778 with the addition of checking for the armed event status.

```
'
' Synchronizing single-shot acquisition using polling.
' =====

Option Explicit

Public myMgr As VisaComLib.ResourceManager
Public myScope As VisaComLib.FormattedIO488
Public varQueryResult As Variant
Public strQueryResult As String

Private Declare Sub Sleep Lib "kernel32" (ByVal dwMilliseconds As Long)

Sub Main()

    On Error GoTo VisaComError

    ' Create the VISA COM I/O resource.
    Set myMgr = New VisaComLib.ResourceManager
    Set myScope = New VisaComLib.FormattedIO488
    Set myScope.IO = myMgr.Open("TCPIP0::130.29.69.12::inst0::INSTR")
    myScope.IO.Clear ' Clear the interface.

    ' Set up.
    ' =====

    ' Set up the trigger and horizontal scale.
    myScope.WriteString ":TRIGger:MODE EDGE"
    myScope.WriteString ":TRIGger:EDGE:LEVel 2"
    myScope.WriteString ":TIMEbase:SCALE 5e-8"

    ' Stop acquisitions and wait for the operation to complete.
    myScope.WriteString ":STOP"
    myScope.WriteString "*OPC?"
    strQueryResult = myScope.ReadString

    ' Acquire.
```

```

' -----
' Start a single acquisition.
myScope.WriteString ":SINGLE"

' Wait until the trigger system is armed.
Do
  Sleep 100 ' Small wait to prevent excessive queries.
  myScope.WriteString ":AER?"
  varQueryResult = myScope.ReadNumber
Loop Until varQueryResult = 1

' Oscilloscope is armed and ready, enable DUT here.
Debug.Print "Oscilloscope is armed and ready, enable DUT."

' Now, look for RUN bit = stopped (acquisition complete).
Dim lngTimeout As Long ' Max millisecs to wait for single-shot.
Dim lngElapsed As Long
lngTimeout = 10000 ' 10 seconds.
lngElapsed = 0

Do While lngElapsed <= lngTimeout
  myScope.WriteString ":OPERRegister:CONdition?"
  varQueryResult = myScope.ReadNumber
  ' Mask RUN bit (bit 3, &H8).
  If (varQueryResult And &H8) = 0 Then
    Exit Do
  Else
    Sleep 100 ' Small wait to prevent excessive queries.
    lngElapsed = lngElapsed + 100
  End If
Loop

' Get results.
' -----
If lngElapsed < lngTimeout Then
  myScope.WriteString ":MEASure:RISetime"
  myScope.WriteString ":MEASure:RISetime?"
  varQueryResult = myScope.ReadNumber ' Read risetime.
  Debug.Print "Risetime: " + _
    FormatNumber(varQueryResult * 1000000000, 1) + " ns"
Else
  Debug.Print "Timeout waiting for single-shot trigger."
End If

Exit Sub

VisaComError:
  MsgBox "VISA COM Error:" + vbCrLf + Err.Description

End Sub

```

Synchronization with an Averaging Acquisition

When averaging, it is necessary to know when the average count has been reached. The :SINGLe command does not average.

If it is known that a trigger will occur, a :DIGitize will acquire the complete number of averages, but if the number of averages is large, a timeout on the connection can occur.

The example below polls during the :DIGitize to prevent a timeout on the connection.

```
'
' Synchronizing in averaging acquisition mode.
' =====

Option Explicit

Public myMgr As VisaComLib.ResourceManager
Public myScope As VisaComLib.FormattedIO488
Public varQueryResult As Variant
Public strQueryResult As String

Private Declare Sub Sleep Lib "kernel32" (ByVal dwMilliseconds As Long)

Sub Main()

    On Error GoTo VisaComError

    ' Create the VISA COM I/O resource.
    Set myMgr = New VisaComLib.ResourceManager
    Set myScope = New VisaComLib.FormattedIO488
    Set myScope.IO = myMgr.Open("TCPIP0::130.29.69.12::inst0::INSTR")
    myScope.IO.Clear ' Clear the interface.
    myScope.IO.Timeout = 5000

    ' Set up.
    ' -----
    ' Set up the trigger and horizontal scale.
    myScope.WriteString ":TRIGger:SWEEp NORMal"
    myScope.WriteString ":TRIGger:MODE EDGE"
    myScope.WriteString ":TRIGger:EDGE:LEVel 2"
    myScope.WriteString ":TIMEbase:SCALE 5e-8"

    ' Stop acquisitions and wait for the operation to complete.
    myScope.WriteString ":STOP"
    myScope.WriteString "*OPC?"
    strQueryResult = myScope.ReadString

    ' Set up average acquisition mode.
    Dim lngAverages As Long
    lngAverages = 256
    myScope.WriteString ":ACQuire:COUNT " + CStr(lngAverages)
    myScope.WriteString ":ACQuire:TYPE AVERAge"
```

```

' Save *ESE (Standard Event Status Enable register) mask
' (so it can be restored later).
Dim varInitialESE As Variant
myScope.WriteString "*ESE?"
varInitialESE = myScope.ReadNumber

' Set *ESE mask to allow only OPC (Operation Complete) bit.
myScope.WriteString "*ESE " + CStr(CInt("&H01"))

' Acquire using :DIGitize. Set up OPC bit to be set when the
' operation is complete.
' -----
myScope.WriteString ":DIGitize"
myScope.WriteString "*OPC"

' Assume the oscilloscope will trigger, if not put a check here.

' Wait until OPC becomes true (bit 5 of Status Byte register, STB,
' from Standard Event Status register, ESR, is set). STB can be
' read during :DIGitize without generating a timeout.
Do
Sleep 4000 ' Poll more often than the timeout setting.
varQueryResult = myScope.IO.ReadSTB
Loop While (varQueryResult And &H20) = 0

' Clear ESR and restore previously saved *ESE mask.
myScope.WriteString "*ESR?" ' Clear ESR by reading it.
varQueryResult = myScope.ReadNumber
myScope.WriteString "*ESE " + CStr(varInitialESE)

' Get results.
' -----
myScope.WriteString ":WAVEform:COUNT?"
varQueryResult = myScope.ReadNumber
Debug.Print "Averaged waveforms: " + CStr(varQueryResult)

myScope.WriteString ":MEASure:RISetime"
myScope.WriteString ":MEASure:RISetime?"
varQueryResult = myScope.ReadNumber ' Read risetime.
Debug.Print "Risetime: " + _
FormatNumber(varQueryResult * 1000000000, 1) + " ns"

Exit Sub

VisaComError:
MsgBox "VISA COM Error:" + vbCrLf + Err.Description

End Sub

```

10 Synchronizing Acquisitions

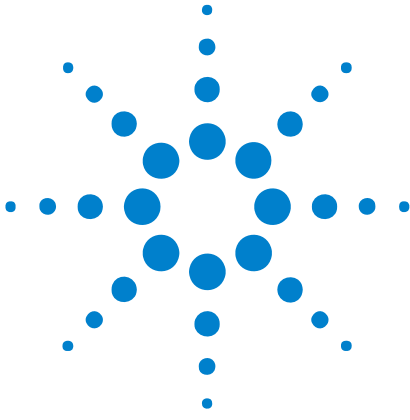

11

More About Oscilloscope Commands

- Command Classifications [786](#)
- Valid Command/Query Strings [787](#)
- Query Return Values [808](#)
- All Oscilloscope Commands Are Sequential [809](#)



Command Classifications

To help you use existing programs with your oscilloscope, or use current programs with the next generation of Agilent InfiniiVision oscilloscopes, commands are classified by the following categories:

- "Core Commands" on page 786
- "Non-Core Commands" on page 786
- "Obsolete Commands" on page 786

C Core Commands

Core commands are a common set of commands that provide basic oscilloscope functionality on this oscilloscope and future Agilent InfiniiVision oscilloscopes. Core commands are unlikely to be modified in the future. If you restrict your programs to core commands, the programs should work across product offerings in the future, assuming appropriate programming methods are employed.

N Non-Core Commands

Non-core commands are commands that provide specific features, but are not universal across all Agilent InfiniiVision oscilloscope models. Non-core commands may be modified or deleted in the future. With a command structure as complex as the one for your oscilloscope, some evolution over time is inevitable. Agilent's intent is to continue to expand command subsystems, such as the rich and evolving trigger feature set.

O Obsolete Commands

Obsolete commands are older forms of commands that are provided to reduce customer rework for existing systems and programs. Generally, these commands are mapped onto some of the Core and Non-core commands, but may not strictly have the same behavior as the new command. None of the obsolete commands are guaranteed to remain functional in future products. New systems and programs should use the Core (and Non-core) commands. Obsolete commands are listed in:

- [Chapter 7](#), "Obsolete and Discontinued Commands," starting on page 687
- As well as: [Chapter 6](#), "Commands A-Z," starting on page 653

Valid Command/Query Strings

- "Program Message Syntax" on page 787
- "Command Tree" on page 791
- "Duplicate Mnemonics" on page 805
- "Tree Traversal Rules and Multiple Commands" on page 806

Program Message Syntax

To program the instrument remotely, you must understand the command format and structure expected by the instrument. The IEEE 488.2 syntax rules govern how individual elements such as headers, separators, program data, and terminators may be grouped together to form complete instructions. Syntax definitions are also given to show how query responses are formatted. The following figure shows the main syntactical parts of a typical program statement.

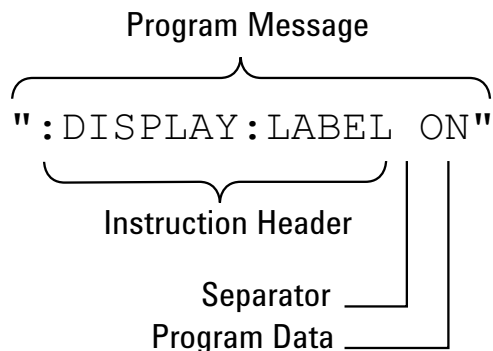

Instructions (both commands and queries) normally appear as a string embedded in a statement of your host language, such as Visual Basic or C/C++. The only time a parameter is not meant to be expressed as a string is when the instruction's syntax definition specifies <block data>, such as <learn string>. There are only a few instructions that use block data.

Program messages can have long or short form commands (and data in some cases – see "Long Form to Short Form Truncation Rules" on page 788), and upper and/or lower case ASCII characters may be used. (Query responses, however, are always returned in upper case.)

Instructions are composed of two main parts:

- The header, which specifies the command or query to be sent.
- The program data, which provide additional information needed to clarify the meaning of the instruction.

Instruction Header The instruction header is one or more mnemonics separated by colons (:) that represent the operation to be performed by the instrument. The "Command Tree" on page 791 illustrates how all the mnemonics can be joined together to form a complete header.

":DISPlay:LABel ON" is a command. Queries are indicated by adding a question mark (?) to the end of the header, for example, ":DISPlay:LABel?". Many instructions can be used as either commands or queries, depending on whether or not you have included the question mark. The command and query forms of an instruction usually have different program data. Many queries do not use any program data.

There are three types of headers:

- "Simple Command Headers" on page 789
- "Compound Command Headers" on page 789
- "Common Command Headers" on page 790

White Space (Separator) White space is used to separate the instruction header from the program data. If the instruction does not require any program data parameters, you do not need to include any white space. White space is defined as one or more space characters. ASCII defines a space to be character 32 (in decimal).

Program Data Program data are used to clarify the meaning of the command or query. They provide necessary information, such as whether a function should be on or off, or which waveform is to be displayed. Each instruction's syntax definition shows the program data, as well as the values they accept. "Program Data Syntax Rules" on page 790 describes all of the general rules about acceptable values.

When there is more than one data parameter, they are separated by commas(.). Spaces can be added around the commas to improve readability.

Program Message Terminator The program instructions within a data message are executed after the program message terminator is received. The terminator may be either an NL (New Line) character, an EOI (End-Or-Identify) asserted in the programming interface, or a combination of the two. Asserting the EOI sets the EOI control line low on the last byte of the data message. The NL character is an ASCII linefeed (decimal 10).

NOTE

New Line Terminator Functions. The NL (New Line) terminator has the same function as an EOS (End Of String) and EOT (End Of Text) terminator.

Long Form to Short Form Truncation Rules

To get the short form of a command/keyword:

- When the command/keyword is longer than four characters, use the first four characters of the command/keyword unless the fourth character is a vowel; when the fourth character is a vowel, use the first three characters of the command/keyword.
- When the command/keyword is four or fewer characters, use all of the characters.

Long Form	Short form
RANGe	RANG
PATTerN	PATT
TIMebase	TIM
DELay	DEL
TYPE	TYPE

In the oscilloscope programmer's documentation, the short form of a command is indicated by uppercase characters.

Programs written in long form are easily read and are almost self-documenting. The short form syntax conserves the amount of controller memory needed for program storage and reduces I/O activity.

Simple Command Headers

Simple command headers contain a single mnemonic. :AUToscale and :DIGitize are examples of simple command headers typically used in the oscilloscope. The syntax is:

```
<program mnemonic><terminator>
```

Simple command headers must occur at the beginning of a program message; if not, they must be preceded by a colon.

When program data must be included with the simple command header (for example, :DIGitize CHANnel1), white space is added to separate the data from the header. The syntax is:

```
<program mnemonic><separator><program data><terminator>
```

Compound Command Headers

Compound command headers are a combination of two or more program mnemonics. The first mnemonic selects the subsystem, and the second mnemonic selects the function within that subsystem. The mnemonics within the compound message are separated by colons. For example, to execute a single function within a subsystem:

```
:<subsystem>:<function><separator><program data><terminator>
```

For example, :CHANnel1:BWLimit ON

Common Command Headers

Common command headers control IEEE 488.2 functions within the instrument (such as clear status). Their syntax is:

```
*<command header><terminator>
```

No space or separator is allowed between the asterisk (*) and the command header. *CLS is an example of a common command header.

Program Data Syntax Rules

Program data is used to convey a parameter information related to the command header. At least one space must separate the command header or query header from the program data.

```
<program mnemonic><separator><data><terminator>
```

When a program mnemonic or query has multiple program data, a comma separates sequential program data.

```
<program mnemonic><separator><data>,<data><terminator>
```

For example, :MEASure:DELAy CHANnel1,CHANnel2 has two program data: CHANnel1 and CHANnel2.

Two main types of program data are used in commands: character and numeric.

Character Program Data

Character program data is used to convey parameter information as alpha or alphanumeric strings. For example, the :TIMEbase:MODE command can be set to normal, zoomed (delayed), XY, or ROLL. The character program data in this case may be MAIN, WINDow, XY, or ROLL. The command :TIMEbase:MODE WINDow sets the time base mode to zoomed.

The available mnemonics for character program data are always included with the command's syntax definition.

When sending commands, you may either the long form or short form (if one exists). Uppercase and lowercase letters may be mixed freely.

When receiving query responses, uppercase letters are used exclusively.

Numeric Program Data

Some command headers require program data to be expressed numerically. For example, :TIMEbase:RANGE requires the desired full scale range to be expressed numerically.

For numeric program data, you have the option of using exponential notation or using suffix multipliers to indicate the numeric value. The following numbers are all equal:

28 = 0.28E2 = 280e-1 = 28000m = 0.028K = 28e-3K.

When a syntax definition specifies that a number is an integer, that means that the number should be whole. Any fractional part will be ignored, truncating the number. Numeric data parameters accept fractional values are called real numbers.

All numbers must be strings of ASCII characters. Thus, when sending the number 9, you would send a byte representing the ASCII code for the character 9 (which is 57). A three-digit number like 102 would take up three bytes (ASCII codes 49, 48, and 50). This is handled automatically when you include the entire instruction in a string.

Command Tree

The command tree shows all of the commands and the relationships of the commands to each other. The IEEE 488.2 common commands are not listed as part of the command tree because they do not affect the position of the parser within the tree. When a program message terminator (<NL>, linefeed-ASCII decimal 10) or a leading colon (:) is sent to the instrument, the parser is set to the root of the command tree.

- **:(root)**
 - :ACQuire (see [page 181](#))
 - :AALias (see [page 183](#))
 - :COMPlEte (see [page 184](#))
 - :COUNT (see [page 185](#))
 - :DAALias (see [page 186](#))
 - :MODE (see [page 187](#))
 - :POINTs (see [page 188](#))
 - :RSIGnal (see [page 189](#))
 - :SEGmented
 - :ANALyze (see [page 190](#))
 - :COUNT (see [page 191](#))
 - :INDEx (see [page 192](#))
 - :SRATE (see [page 195](#))
 - :TYPE (see [page 196](#))
 - :ACTivity (see [page 142](#))
 - :AER (Arm Event Register) (see [page 143](#))
 - :AUToscale (see [page 144](#))
 - :AMODE (see [page 146](#))
 - :CHANnels (see [page 147](#))
 - :BLANK (see [page 148](#))
 - :BUS<n> (see [page 198](#))

- :BIT<m> (see [page 200](#))
- :BITS (see [page 201](#))
- :CLEar (see [page 203](#))
- :DISPlay (see [page 204](#))
- :LABel (see [page 205](#))
- :MASK (see [page 206](#))
- :CALibrate (see [page 207](#))
 - :DATE (see [page 209](#))
 - :LABel (see [page 210](#))
 - :OUTPut (see [page 211](#))
 - :STARt (see [page 212](#))
 - :STATus (see [page 213](#))
 - :SWITch (see [page 214](#))
 - :TEMPerature (see [page 215](#))
 - :TIME (see [page 216](#))
- :CDISplay (see [page 149](#))
- :CHANnel<n> (see [page 217](#))
 - :BWLimit (see [page 220](#))
 - :COUPling (see [page 221](#))
 - :DISPlay (see [page 222](#))
 - :IMPedance (see [page 223](#))
 - :INVert (see [page 224](#))
 - :LABel (see [page 225](#))
 - :OFFSet (see [page 226](#))
 - :PROBe (see [page 227](#))
 - :HEAD[:TYPE] (see [page 228](#))
 - :ID (see [page 229](#))
 - :SKEW (see [page 230](#))
 - :STYPe (see [page 231](#))
 - :PROTection (see [page 232](#))
 - :RANGe (see [page 233](#))
 - :SCALE (see [page 234](#))
 - :UNITs (see [page 235](#))
 - :VERNier (see [page 236](#))
- :DIGital<n> (see [page 237](#))

- :DISPlay (see [page 239](#))
- :LABel (see [page 240](#))
- :POSition (see [page 241](#))
- :SIZE (see [page 242](#))
- :THReshold (see [page 243](#))
- :DIGitize (see [page 150](#))
- :DISPlay (see [page 244](#))
 - :CLEar (see [page 246](#))
 - :DATA (see [page 247](#))
 - :LABel (see [page 249](#))
 - :LABList (see [page 250](#))
 - :PERsistence (see [page 251](#))
 - :SOURce (see [page 252](#))
 - :VECTors (see [page 253](#))
- :EXTernal (see [page 254](#))
 - :BWLimit (see [page 256](#))
 - :IMPedance (see [page 257](#))
 - :PROBe (see [page 258](#))
 - :ID (see [page 259](#))
 - :STYPe (see [page 260](#))
 - :PROTection (see [page 261](#))
 - :RANGe (see [page 262](#))
 - :UNITs (see [page 263](#))
- :FUNCTion (see [page 264](#))
 - :CENTer (see [page 267](#))
 - :DISPlay (see [page 268](#))
 - :GOFT
 - :OPERation (see [page 269](#))
 - :SOURce1 (see [page 270](#))
 - :SOURce2 (see [page 271](#))
 - :OFFSet (see [page 272](#))
 - :OPERation (see [page 273](#))
 - :RANGe (see [page 274](#))
 - :REFerence (see [page 275](#))
 - :SCALe (see [page 276](#))

- :SOURce1 (see [page 277](#))
- :SOURce2 (see [page 278](#))
- :SPAN (see [page 279](#))
- :WINDow (see [page 280](#))
- :HARDcopy (see [page 281](#))
 - :AREA (see [page 283](#))
 - :APRinter (see [page 284](#))
 - :FACTors (see [page 285](#))
 - :FFEed (see [page 286](#))
 - :INKSaver (see [page 287](#))
 - :LAYout (see [page 288](#))
 - :PALette (see [page 289](#))
 - [:PRINter]
 - :LIST (see [page 290](#))
 - [:STARt] (see [page 291](#))
- :HWEenable (Hardware Event Enable Register) (see [page 152](#))
- :HWERegister
 - :CONDition (Hardware Event Condition Register) (see [page 154](#))
 - [:EVENT] (Hardware Event Event Register) (see [page 156](#))
- :LISTer (see [page 292](#))
 - :DATA (see [page 293](#))
 - :DISPlay (see [page 294](#))
- :MARKer (see [page 295](#))
 - :MODE (see [page 297](#))
 - :X1Position (see [page 298](#))
 - :X1Y1source (see [page 299](#))
 - :X2Position (see [page 300](#))
 - :X2Y2source (see [page 301](#))
 - :XDELta (see [page 302](#))
 - :Y1Position (see [page 303](#))
 - :Y2Position (see [page 304](#))
 - :YDELta (see [page 305](#))
- :MEASure (see [page 306](#))
 - :CLEar (see [page 314](#))
 - :COUNter (see [page 315](#))

- :DEFine (see [page 316](#))
 - :DELay (see [page 319](#))
 - :DUTYcycle (see [page 321](#))
 - :FALLtime (see [page 322](#))
 - :FREQuency (see [page 323](#))
 - :NWIDth (see [page 324](#))
 - :OVERshoot (see [page 325](#))
 - :PERiod (see [page 327](#))
 - :PHASe (see [page 328](#))
 - :PREShoot (see [page 329](#))
 - :PWIDth (see [page 330](#))
 - :RISetime (see [page 334](#))
 - :RESults (see [page 331](#))
 - :SDEViation (see [page 335](#))
 - :SHOW (see [page 336](#))
 - :SOURce (see [page 337](#))
 - :STATistics (see [page 339](#))
 - :INCRement (see [page 340](#))
 - :RESet (see [page 341](#))
 - :TEDGe (see [page 342](#))
 - :TVALue (see [page 344](#))
 - :VAMPLitude (see [page 346](#))
 - :VAverage (see [page 347](#))
 - :VBASe (see [page 348](#))
 - :VMAX (see [page 349](#))
 - :VMIN (see [page 350](#))
 - :VPP (see [page 351](#))
 - :VRATio (see [page 352](#))
 - :VRMS (see [page 353](#))
 - :VTIME (see [page 354](#))
 - :VTOP (see [page 355](#))
 - :XMAX (see [page 356](#))
 - :XMIN (see [page 357](#))
- :MERGe (see [page 158](#))
 - :MTEenable (Mask Test Event Enable Register) (see [page 159](#))

- :MTERegister[:EVENT] (Mask Test Event Event Register) (see [page 161](#))
- :MTESt (see [page 358](#))
 - :AMASk
 - :CREate (see [page 363](#))
 - :SOURCe (see [page 364](#))
 - :UNITs (see [page 365](#))
 - :XDELta (see [page 366](#))
 - :YDELta (see [page 367](#))
 - :COUNt
 - :FWAVeforms (see [page 368](#))
 - :RESet (see [page 369](#))
 - :TIME (see [page 370](#))
 - :WAVeforms (see [page 371](#))
 - :DATA (see [page 372](#))
 - :DELeTe (see [page 373](#))
 - :ENABle (see [page 374](#))
 - :LOCK (see [page 375](#))
 - :OUTPut (see [page 376](#))
 - :RMODE (see [page 377](#))
 - :FACtion
 - :MEASure (see [page 378](#))
 - :PRINt (see [page 379](#))
 - :SAVE (see [page 380](#))
 - :STOP (see [page 381](#))
 - :SIGMa (see [page 382](#))
 - :TIME (see [page 383](#))
 - :WAVeforms (see [page 384](#))
 - :SCALe
 - :BIND (see [page 385](#))
 - :X1 (see [page 386](#))
 - :XDELta (see [page 387](#))
 - :Y1 (see [page 388](#))
 - :Y2 (see [page 389](#))
 - :SOURce (see [page 390](#))
 - :TITLe (see [page 391](#))

- :OPEE (Operation Status Enable Register) (see [page 163](#))
- :OPERRegister
 - :CONDition (Operation Status Condition Register) (see [page 165](#))
 - [:EVENT] (Operation Status Event Register) (see [page 167](#))
- :OVLenable (Overload Event Enable Register) (see [page 169](#))
- :OVLRegister (Overload Event Register) (see [page 171](#))
- :POD<n> (see [page 392](#))
 - :DISPlay (see [page 393](#))
 - :SIZE (see [page 394](#))
 - :THReshold (see [page 395](#))
- :RECall
 - :FILename (see [page 398](#))
 - :IMAGe (see [page 399](#))
 - [:START] (see [page 399](#))
 - :MASK (see [page 400](#))
 - [:START] (see [page 400](#))
 - :PWD (see [page 401](#))
 - :SETup (see [page 402](#))
 - [:START] (see [page 402](#))
- :RUN (see [page 174](#))
- :SAVE
 - :FILename (see [page 405](#))
 - :IMAGe (see [page 406](#))
 - [:START] (see [page 406](#))
 - :AREA (see [page 407](#))
 - :FACTors (see [page 408](#))
 - :FORMat (see [page 409](#))
 - :IGColors (see [page 410](#))
 - :PALette (see [page 411](#))
 - :LISTer (see [page 412](#))
 - [:START] (see [page 412](#))
 - :MASK (see [page 413](#))
 - [:START] (see [page 413](#))
 - :PWD (see [page 414](#))
 - :SETup (see [page 415](#))

- [:START] (see [page 415](#))
- :WAVEform (see [page 416](#))
 - [:START] (see [page 416](#))
 - :FORMat (see [page 417](#))
 - :LENGth (see [page 418](#))
 - :SEGmented (see [page 419](#))
- :SBUS (see [page 420](#))
 - :CAN
 - :COUNT
 - :ERRor (see [page 422](#))
 - :OVERload (see [page 423](#))
 - :RESet (see [page 424](#))
 - :TOTal (see [page 425](#))
 - :UTILization (see [page 426](#))
 - :DISPlay (see [page 427](#))
 - :FLEXray
 - :COUNT
 - :NULL? (see [page 428](#))
 - :RESet (see [page 429](#))
 - :SYNC? (see [page 430](#))
 - :TOTal? (see [page 431](#))
- :I2S
 - :BASE (see [page 432](#))
- :IIC
 - :ASIZE (see [page 433](#))
- :LIN
 - :PARity (see [page 434](#))
- :M1553
 - :BASE (see [page 435](#))
- :MODE (see [page 436](#))
- :SPI
 - :BITorder (see [page 437](#))
 - :WIDTh (see [page 438](#))
- :UART
 - :BASE (see [page 439](#))

- :COUNT
 - :ERRor (see [page 440](#))
 - :RESet (see [page 441](#))
 - :RXFRames (see [page 442](#))
 - :TXFRames (see [page 443](#))
 - :FRAMing (see [page 444](#))
- :SERial (see [page 175](#))
- :SINGle (see [page 176](#))
- :STATus (see [page 177](#))
- :STOP (see [page 178](#))
- :SYSTem (see [page 445](#))
 - :DATE (see [page 446](#))
 - :DSP (see [page 447](#))
 - :ERRor (see [page 448](#))
 - :LOCK (see [page 449](#))
 - :PRECision (see [page 450](#))
 - :PROTection
 - :LOCK (see [page 433](#))
 - :SETup (see [page 452](#))
 - :TIME (see [page 454](#))
- :TER (Trigger Event Register) (see [page 179](#))
- :TIMEbase (see [page 455](#))
 - :MODE (see [page 457](#))
 - :POSition (see [page 458](#))
 - :RANGe (see [page 459](#))
 - :REFClock (see [page 460](#))
 - :REFerence (see [page 461](#))
 - :SCALE (see [page 462](#))
 - :VERNier (see [page 463](#))
 - :WINDow
 - :POSition (see [page 464](#))
 - :RANGe (see [page 465](#))
 - :SCALE (see [page 466](#))
- :TRIGger (see [page 467](#))
 - :HFReject (see [page 471](#))

- :HOLDoff (see [page 472](#))
- :MODE (see [page 473](#))
- :NREject (see [page 474](#))
- :PATTern (see [page 475](#))
- :SWEep (see [page 477](#))
- :CAN (see [page 478](#))
 - :ACKnowledge (see [page 738](#))
 - :PATTern
 - :DATA (see [page 480](#))
 - :LENGth (see [page 481](#))
 - :ID (see [page 482](#))
 - :MODE (see [page 483](#))
 - :SAMPlepoint (see [page 484](#))
 - :SIGNal
 - :BAUDrate (see [page 485](#))
 - :DEFinition (see [page 739](#))
 - :SOURce (see [page 486](#))
 - :TRIGger (see [page 487](#))
- :DURation (see [page 489](#))
 - :GREaterthan (see [page 490](#))
 - :LESSthan (see [page 491](#))
 - :PATTern (see [page 492](#))
 - :QUALifier (see [page 493](#))
 - :RANGe (see [page 494](#))
- :EBURst (see [page 495](#))
 - :COUNT (see [page 496](#))
 - :IDLE (see [page 497](#))
 - :SLOPe (see [page 498](#))
- [:EDGE] (see [page 499](#))
 - :COUPling (see [page 500](#))
 - :LEVel (see [page 501](#))
 - :REJect (see [page 502](#))
 - :SLOPe (see [page 503](#))
 - :SOURce (see [page 504](#))
- :FLEXray (see [page 505](#))

- :AUToset (see [page 506](#))
- :BAUDrate (see [page 507](#))
- :CHANnel (see [page 508](#))
- :ERRor
 - :TYPE (see [page 509](#))
- :EVENT
 - :TYPE (see [page 510](#))
- :FRAME
 - :CCBase (see [page 511](#))
 - :CCRepetition (see [page 512](#))
 - :ID (see [page 513](#))
 - :TYPE (see [page 514](#))
- :SOURce (see [page 515](#))
- :TRIGger (see [page 516](#))
- :GLITch (see [page 517](#))
 - :GREaterthan (see [page 519](#))
 - :LESSthan (see [page 520](#))
 - :LEVel (see [page 521](#))
 - :POLarity (see [page 522](#))
 - :QUALifier (see [page 523](#))
 - :RANGe (see [page 524](#))
 - :SOURce (see [page 525](#))
- :HFReject (see [page 471](#))
- :HOLDoff (see [page 472](#))
- :I2S (see [page 526](#))
 - :ALIGNment (see [page 528](#))
 - :AUDio (see [page 529](#))
 - :CLOCK
 - :SLOPe (see [page 530](#))
 - :PATTern
 - :DATA (see [page 531](#))
 - :FORMat (see [page 533](#))
 - :RANGe (see [page 534](#))
 - :RWIDth (see [page 536](#))
 - :SOURce

11 More About Oscilloscope Commands

- :CLOCK (see [page 537](#))
- :DATA (see [page 538](#))
- :WSElect (see [page 539](#))
- :TRIGger (see [page 540](#))
- :TWIDth (see [page 542](#))
- :WSLow (see [page 543](#))
- :IIC (see [page 544](#))
 - :PATTern
 - :ADDRes (see [page 545](#))
 - :DATA (see [page 546](#))
 - :DATa2 (see [page 547](#))
 - :SOURce
 - :CLOCK (see [page 548](#))
 - :DATA (see [page 549](#))
 - :TRIGger
 - :QUALifier (see [page 550](#))
 - [:TYPE] (see [page 551](#))
- :LIN (see [page 553](#))
 - :ID (see [page 555](#))
 - :PATTern
 - :DATA (see [page 556](#))
 - :LENGth (see [page 558](#))
 - :FORMat (see [page 559](#))
 - :SAMPlEpoint (see [page 560](#))
 - :SIGNal
 - :BAUDrate (see [page 561](#))
 - :DEFinition (see [page 740](#))
 - :SOURce (see [page 562](#))
 - :STANdard (see [page 563](#))
 - :SYNCbreak (see [page 564](#))
 - :TRIGger (see [page 565](#))
- :M1553 (see [page 566](#))
 - :AUTosetup (see [page 567](#))
 - :PATTern
 - :DATA (see [page 568](#))

- :RTA (see [page 569](#))
- :SOURce
 - :LOWer (see [page 570](#))
 - :UPPer (see [page 571](#))
- :TYPE (see [page 572](#))
- :MODE (see [page 473](#))
- :NREJect (see [page 474](#))
- :PATtern (see [page 475](#))
- :SEQuence (see [page 573](#))
 - :COUNT (see [page 574](#))
 - :EDGE (see [page 575](#))
 - :FIND (see [page 576](#))
 - :PATtern (see [page 577](#))
 - :RESet (see [page 578](#))
 - :TIMer (see [page 579](#))
 - :TRIGger (see [page 580](#))
- :SPI (see [page 581](#))
 - :CLOCK
 - :SLOPe (see [page 582](#))
 - :TIMEout (see [page 583](#))
 - :FRAMing (see [page 584](#))
 - :PATtern
 - :DATA (see [page 585](#))
 - :WIDTh (see [page 586](#))
 - :SOURce
 - :CLOCK (see [page 587](#))
 - :DATA (see [page 588](#))
 - :FRAMe (see [page 589](#))
- :SWEep (see [page 477](#))
- :TV (see [page 590](#))
 - :LINE (see [page 591](#))
 - :MODE (see [page 592](#))
 - :POLarity (see [page 593](#))
 - :SOURce (see [page 594](#))
 - :STANdard (see [page 595](#))

- :TVMode (see [page 742](#))
- :UART (see [page 596](#))
 - :BASE (see [page 598](#))
 - :BAUDrate (see [page 599](#))
 - :BITorder (see [page 600](#))
 - :BURSt (see [page 601](#))
 - :DATA (see [page 602](#))
 - :IDLE (see [page 603](#))
 - :PARity (see [page 604](#))
 - :QUALifier (see [page 606](#))
 - :POLarity (see [page 605](#))
 - :SOURce
 - :RX (see [page 607](#))
 - :TX (see [page 608](#))
 - :TYPE (see [page 609](#))
 - :WIDTh (see [page 610](#))
- :USB (see [page 611](#))
 - :SOURce
 - :DMINus (see [page 612](#))
 - :DPLus (see [page 613](#))
 - :SPEed (see [page 614](#))
 - :TRIGger (see [page 615](#))
- :VIEW (see [page 180](#))
- :WAVEform (see [page 616](#))
 - :BYTeorder (see [page 624](#))
 - :COUNT (see [page 625](#))
 - :DATA (see [page 626](#))
 - :FORMat (see [page 628](#))
 - :POINTs (see [page 629](#))
 - :MODE (see [page 631](#))
 - :PREamble (see [page 633](#))
 - :SEGmented
 - :COUNT (see [page 636](#))
 - :TTAG (see [page 637](#))
 - :SOURce (see [page 638](#))

- :SUBSource (see [page 642](#))
- :TYPE (see [page 643](#))
- :UNSigned (see [page 644](#))
- :VIEW (see [page 645](#))
- :XINCrement (see [page 646](#))
- :XORigin (see [page 647](#))
- :XREFerence (see [page 648](#))
- :YINCrement (see [page 649](#))
- :YORigin (see [page 650](#))
- :YREFerence (see [page 651](#))

**Common
Commands (IEEE
488.2)**

- *CLS (see [page 117](#))
- *ESE (see [page 118](#))
- *ESR (see [page 120](#))
- *IDN (see [page 122](#))
- *LRN (see [page 123](#))
- *OPC (see [page 124](#))
- *OPT (see [page 125](#))
- *RCL (see [page 127](#))
- *RST (see [page 128](#))
- *SAV (see [page 131](#))
- *SRE (see [page 132](#))
- *STB (see [page 134](#))
- *TRG (see [page 136](#))
- *TST (see [page 137](#))
- *WAI (see [page 138](#))

Duplicate Mnemonics

Identical function mnemonics can be used in more than one subsystem. For example, the function mnemonic RANGe may be used to change the vertical range or to change the horizontal range:

```
:CHANnel1:RANGe .4
```

Sets the vertical range of channel 1 to 0.4 volts full scale.

```
:TIMebase:RANGe 1
```

Sets the horizontal time base to 1 second full scale.

:CHANnel1 and :TIMebase are subsystem selectors and determine which range is being modified.

Tree Traversal Rules and Multiple Commands

Command headers are created by traversing down the Command Tree (see [page 791](#)). A legal command header would be :TIMebase:RANGe. This is referred to as a *compound header*. A compound header is a header made of two or more mnemonics separated by colons. The mnemonic created contains no spaces.

The following rules apply to traversing the tree:

- A leading colon (<NL> or EOI true on the last byte) places the parser at the root of the command tree. A leading colon is a colon that is the first character of a program header. Executing a subsystem command lets you access that subsystem until a leading colon or a program message terminator (<NL>) or EOI true is found.
- In the command tree, use the last mnemonic in the compound header as the reference point (for example, RANGe). Then find the last colon above that mnemonic (TIMebase:). That is the point where the parser resides. Any command below that point can be sent within the current program message without sending the mnemonics which appear above them (for example, POSition).

The output statements in the examples are written using the Agilent VISA COM library in Visual Basic. The quoted string is placed on the bus, followed by a carriage return and linefeed (CRLF).

To execute more than one function within the same subsystem, separate the functions with a semicolon (;):

```
:<subsystem>:<function><separator><data>;<function><separator><data><terminator>
```

For example:

```
myScope.WriteString ":TIMebase:RANGe 0.5;POSition 0"
```

NOTE

The colon between TIMebase and RANGe is necessary because TIMebase:RANGe is a compound command. The semicolon between the RANGe command and the POSition command is the required program message unit separator. The POSition command does not need TIMebase preceding it because the TIMebase:RANGe command sets the parser to the TIMebase node in the tree.

Example 2:
Program
Message
Terminator Sets
Parser Back to
Root

```
myScope.WriteString ":TIMEbase:REFErence CENTer;POSition 0.00001"
```

or

```
myScope.WriteString ":TIMEbase:REFErence CENTer"  

myScope.WriteString ":TIMEbase:POSition 0.00001"
```

NOTE

In the first line of example 2, the subsystem selector is implied for the POSition command in the compound command. The POSition command must be in the same program message as the REFErence command because the program message terminator places the parser back at the root of the command tree.

A second way to send these commands is by placing TIMEbase: before the POSition command as shown in the second part of example 2. The space after POSition is required.

Example 3:
Selecting
Multiple
Subsystems

You can send multiple program commands and program queries for different subsystems on the same line by separating each command with a semicolon. The colon following the semicolon enables you to enter a new subsystem. For example:

```
<program mnemonic><data>;:<program mnemonic><data><terminator>
```

For example:

```
myScope.WriteString ":TIMEbase:REFErence CENTer;:DISPlay:VECTors ON"
```

NOTE

The leading colon before DISPlay:VECTors ON tells the parser to go back to the root of the command tree. The parser can then see the DISPlay:VECTors ON command. The space between REFErence and CENTer is required; so is the space between VECTors and ON.

Multiple commands may be any combination of compound and simple commands.

Query Return Values

Command headers immediately followed by a question mark (?) are queries. Queries are used to get results of measurements made by the instrument or to find out how the instrument is currently configured.

After receiving a query, the instrument interrogates the requested function and places the answer in its output queue. The answer remains in the output queue until it is read or another command is issued.

When read, the answer is transmitted across the bus to the designated listener (typically a controller). For example, the query `:TIMEbase:RANGe?` places the current time base setting in the output queue. When using the Agilent VISA COM library in Visual Basic, the controller statements:

```
Dim strQueryResult As String
myScope.WriteString ":TIMEbase:RANGe?"
strQueryResult = myScope.ReadString
```

pass the value across the bus to the controller and place it in the variable `strQueryResult`.

NOTE

Read Query Results Before Sending Another Command. Sending another command or query before reading the result of a query clears the output buffer (the current response) and places a Query INTERRUPTED error in the error queue.

Infinity Representation

The representation of infinity is `+9.9E+37`. This is also the value returned when a measurement cannot be made.

All Oscilloscope Commands Are Sequential

IEEE 488.2 makes the distinction between sequential and overlapped commands:

- *Sequential commands* finish their task before the execution of the next command starts.
- *Overlapped commands* run concurrently. Commands following an overlapped command may be started before the overlapped command is completed.

All of the oscilloscope commands are sequential.

11 More About Oscilloscope Commands

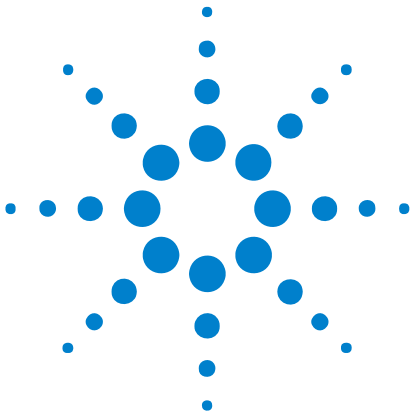

12 Programming Examples

VISA COM Examples [812](#)

VISA Examples [845](#)

SICL Examples [891](#)

Example programs are ASCII text files that can be cut from the help file and pasted into your favorite text editor.



VISA COM Examples

- ["VISA COM Example in Visual Basic"](#) on page 812
- ["VISA COM Example in C#"](#) on page 822
- ["VISA COM Example in Visual Basic .NET"](#) on page 834

VISA COM Example in Visual Basic

To run this example in Visual Basic for Applications (VBA):

- 1 Start the application that provides Visual Basic for Applications (for example, Microsoft Excel).
- 2 Press ALT+F11 to launch the Visual Basic editor.
- 3 Reference the Agilent VISA COM library:
 - a Choose **Tools>References...** from the main menu.
 - b In the References dialog, check the "VISA COM 3.0 Type Library".
 - c Click **OK**.
- 4 Choose **Insert>Module**.
- 5 Cut-and-paste the code that follows into the editor.
- 6 Edit the program to use the VISA address of your oscilloscope, and save the changes.
- 7 Run the program.

```
'
' Agilent VISA COM Example in Visual Basic
' -----
' This program illustrates most of the commonly used programming
' features of your Agilent oscilloscopes.
' -----

Option Explicit

Public myMgr As VisaComLib.ResourceManager
Public myScope As VisaComLib.FormattedIO488
Public varQueryResult As Variant
Public strQueryResult As String

'
' MAIN PROGRAM
' -----
' This example shows the fundamental parts of a program (initialize,
' capture, analyze).
'
' The commands sent to the oscilloscope are written in both long and
' short form. Both forms are acceptable.
'
' The input signal is the probe compensation signal from the front
' panel of the oscilloscope connected to channel 1.
```

```

'
' If you are using a different signal or different channels, these
' commands may not work as explained in the comments.
' -----

Sub Main()

    On Error GoTo VisaComError

    ' Create the VISA COM I/O resource.
    Set myMgr = New VisaComLib.ResourceManager
    Set myScope = New VisaComLib.FormattedIO488

    ' GPIB.
    'Set myScope.IO = myMgr.Open("GPIB0::7::INSTR")

    ' LAN.
    'Set myScope.IO = myMgr.Open("TCPIP0::a-mso6102-90541::inst0::INSTR")

    ' USB.
    Set myScope.IO = myMgr.Open("USB0::2391::5970::30D3090541::0::INSTR")

    ' Initialize - Initialization will start the program with the
    ' oscilloscope in a known state.
    Initialize

    ' Capture - After initialization, you must make waveform data
    ' available to analyze. To do this, capture the data using the
    ' DIGITIZE command.
    Capture

    ' Analyze - Once the waveform has been captured, it can be analyzed.
    ' There are many parts of a waveform to analyze. This example shows
    ' some of the possible ways to analyze various parts of a waveform.
    Analyze

    Exit Sub

VisaComError:
    MsgBox "VISA COM Error:" + vbCrLf + Err.Description

End Sub

'
' Initialize
' -----
' Initialize will start the program with the oscilloscope in a known
' state. This is required because some uninitialized conditions could
' cause the program to fail or not perform as expected.
'
' In this example, we initialize the following:
' - Oscilloscope
' - Channel 1 range
' - Display Grid
' - Timebase reference, range, and delay
' - Trigger mode and type
'

```

12 Programming Examples

```
' There are also some additional initialization commands, which are
' not used, but shown for reference.
' -----

Private Sub Initialize()

    On Error GoTo VisaComError

    ' Clear the interface.
    myScope.IO.Clear

    ' RESET - This command puts the oscilloscope into a known state.
    ' This statement is very important for programs to work as expected.
    ' Most of the following initialization commands are initialized by
    ' *RST. It is not necessary to reinitialize them unless the default
    ' setting is not suitable for your application.
    myScope.WriteString "*RST"    ' Reset the oscilloscope to the defaults.

    ' AUTOSCALE - This command evaluates all the input signals and sets
    ' the correct conditions to display all of the active signals.

    ' Same as pressing the Autoscale key.
    myScope.WriteString ":AUTOSCALE"

    ' CHANNEL_PROBE - Sets the probe attenuation factor for the selected
    ' channel. The probe attenuation factor may be set from 0.1 to 1000.
    myScope.WriteString ":CHAN1:PROBE 10"    ' Set Probe to 10:1.

    ' CHANNEL_RANGE - Sets the full scale vertical range in volts. The
    ' range value is 8 times the volts per division.

    ' Set the vertical range to 8 volts.
    myScope.WriteString ":CHANNEL1:RANGE 8"

    ' TIME_RANGE - Sets the full scale horizontal time in seconds. The
    ' range value is 10 times the time per division.

    ' Set the time range to 0.002 seconds.
    myScope.WriteString ":TIM:RANG 2e-3"

    ' TIME_REFERENCE - Possible values are LEFT and CENTER.
    ' - LEFT sets the display reference on time division from the left.
    ' - CENTER sets the display reference to the center of the screen.

    ' Set reference to center.
    myScope.WriteString ":TIMEBASE:REFERENCE CENTER"

    ' TRIGGER_TV_SOURCE - Selects the channel that actually produces the
    ' TV trigger. Any channel can be selected.
    myScope.WriteString ":TRIGGER:TV:SOURCE CHANNEL1"

    ' TRIGGER_MODE - Set the trigger mode to EDGE, GLITCh, PATtern, CAN,
    ' DURATION, IIC, LIN, SEQuence, SPI, TV, or USB.

    ' Set the trigger mode to EDGE.
    myScope.WriteString ":TRIGGER:MODE EDGE"
```

```

' TRIGGER_EDGE_SLOPE - Sets the slope of the edge for the trigger.

' Set the slope to positive.
myScope.WriteString ":TRIGGER:EDGE:SLOPE POSITIVE"

' The following commands are not executed and are shown for reference
' purposes only. To execute these commands, uncomment them.

' RUN_STOP - (not executed in this example)
' - RUN starts the acquisition of data for the active waveform
'   display.
' - STOP stops the data acquisition and turns off AUTOSTORE.
' myScope.WriteString ":RUN"      ' Start data acquisition.
' myScope.WriteString ":STOP"    ' Stop the data acquisition.

' VIEW_BLANK - (not executed in this example)
' - VIEW turns on (starts displaying) a channel or pixel memory.
' - BLANK turns off (stops displaying) a channel or pixel memory.
' myScope.WriteString ":BLANK CHANNEL1"  ' Turn channel 1 off.
' myScope.WriteString ":VIEW CHANNEL1"   ' Turn channel 1 on.

' TIMEBASE_MODE - (not executed in this example)
' Set the time base mode to MAIN, DELAYED, XY, or ROLL.

' Set time base mode to main.
' myScope.WriteString ":TIMEBASE:MODE MAIN"

Exit Sub

VisaComError:
  MsgBox "VISA COM Error:" + vbCrLf + Err.Description

End Sub

'
' Capture
' -----
' We will capture the waveform using the digitize command.
' -----

Private Sub Capture()

  On Error GoTo VisaComError

  ' ACQUIRE_TYPE - Sets the acquisition mode, which can be NORMAL,
  ' PEAK, or AVERAGE.
  myScope.WriteString ":ACQUIRE:TYPE NORMAL"

  ' ACQUIRE_COMPLETE - Specifies the minimum completion criteria for
  ' an acquisition. The parameter determines the percentage of time
  ' buckets needed to be "full" before an acquisition is considered
  ' to be complete.
  myScope.WriteString ":ACQUIRE:COMPLETE 100"

  ' DIGITIZE - Used to acquire the waveform data for transfer over
  ' the interface. Sending this command causes an acquisition to
  ' take place with the resulting data being placed in the buffer.

```

12 Programming Examples

```
'
' NOTE! The DIGITIZE command is highly recommended for triggering
' modes other than SINGLE. This ensures that sufficient data is
' available for measurement. If DIGITIZE is used with single mode,
' the completion criteria may never be met. The number of points
' gathered in Single mode is related to the sweep speed, memory
' depth, and maximum sample rate. For example, take an oscilloscope
' with a 1000-point memory, a sweep speed of 10 us/div (100 us
' total time across the screen), and a 20 MSa/s maximum sample rate.
' 1000 divided by 100 us equals 10 MSa/s. Because this number is
' less than or equal to the maximum sample rate, the full 1000 points
' will be digitized in a single acquisition. Now, use 1 us/div
' (10 us across the screen). 1000 divided by 10 us equals 100 MSa/s;
' because this is greater than the maximum sample rate by 5 times,
' only 400 points (or 1/5 the points) can be gathered on a single
' trigger. Keep in mind when the oscilloscope is running,
' communication with the computer interrupts data acquisition.
' Setting up the oscilloscope over the bus causes the data buffers
' to be cleared and internal hardware to be reconfigured. If a
' measurement is immediately requested, there may have not been
' enough time for the data acquisition process to collect data,
' and the results may not be accurate. An error value of 9.9E+37
' may be returned over the bus in this situation.
'
myScope.WriteString ":DIGITIZE CHAN1"

Exit Sub

VisaComError:
    MsgBox "VISA COM Error:" + vbCrLf + Err.Description

End Sub

'
' Analyze
' -----
' In analyze, we will do the following:
' - Save the system setup to a file and restore it.
' - Save the waveform data to a file on the computer.
' - Make single channel measurements.
' - Save the oscilloscope display to a file that can be sent to a
'   printer.
' -----

Private Sub Analyze()

    On Error GoTo VisaComError

    ' SAVE_SYSTEM_SETUP - The :SYSTEM:SETUP? query returns a program
    ' message that contains the current state of the instrument. Its
    ' format is a definite-length binary block, for example,
    '   #800002204<setup string><NL>
    ' where the setup string is 2204 bytes in length.
    myScope.WriteString ":SYSTEM:SETUP?"
    varQueryResult = myScope.ReadIEEEBlock(BinaryType_UI1)
    CheckForInstrumentErrors ' After reading query results.
    ' Output setup string to a file:
```



```

Dim strPath As String
strPath = "c:\scope\config\setup.dat"
Close #1 ' If #1 is open, close it.
' Open file for output.
Open strPath For Binary Access Write Lock Write As #1
Put #1, , varQueryResult ' Write data.
Close #1 ' Close file.

' IMAGE_TRANSFER - In this example, we will query for the image data
' with ":DISPLAY:DATA?", read the data, and then save it to a file.
Dim byteData() As Byte
myScope.IO.Timeout = 15000
myScope.WriteString ":DISPLAY:DATA? BMP, SCREEN, COLOR"
byteData = myScope.ReadIEEEBlock(BinaryType_UI1)
' Output display data to a file:
strPath = "c:\scope\data\screen.bmp"
' Remove file if it exists.
If Len(Dir(strPath)) Then
    Kill strPath
End If
Close #1 ' If #1 is open, close it.
' Open file for output.
Open strPath For Binary Access Write Lock Write As #1
Put #1, , byteData ' Write data.
Close #1 ' Close file.
myScope.IO.Timeout = 5000

' RESTORE_SYSTEM_SETUP - Read the setup string from a file and write
' it back to the oscilloscope.
Dim varSetupString As Variant
strPath = "c:\scope\config\setup.dat"
Open strPath For Binary Access Read As #1 ' Open file for input.
Get #1, , varSetupString ' Read data.
Close #1 ' Close file.
' Write setup string back to oscilloscope using ":SYSTEM:SETUP"
' command:
myScope.WriteIEEEBlock ":SYSTEM:SETUP ", varSetupString
CheckForInstrumentErrors

' MEASURE - The commands in the MEASURE subsystem are used to make
' measurements on displayed waveforms.

' Source to measure.
myScope.WriteString ":MEASURE:SOURCE CHANNEL1"

' Query for frequency.
myScope.WriteString ":MEASURE:FREQUENCY?"
varQueryResult = myScope.ReadNumber ' Read frequency.
MsgBox "Frequency:" + vbCrLf + _
    FormatNumber(varQueryResult / 1000, 4) + " kHz"

' Query for duty cycle.
myScope.WriteString ":MEASURE:DUTYCYCLE?"
varQueryResult = myScope.ReadNumber ' Read duty cycle.
MsgBox "Duty cycle:" + vbCrLf + _
    FormatNumber(varQueryResult, 3) + "%"

```

```

' Query for risetime.
myScope.WriteString ":MEASURE:RISETIME?"
varQueryResult = myScope.ReadNumber ' Read risetime.
MsgBox "Risetime:" + vbCrLf + _
    FormatNumber(varQueryResult * 1000000, 4) + " us"

' Query for Peak to Peak voltage.
myScope.WriteString ":MEASURE:VPP?"
varQueryResult = myScope.ReadNumber ' Read VPP.
MsgBox "Peak to peak voltage:" + vbCrLf + _
    FormatNumber(varQueryResult, 4) + " V"

' Query for Vmax.
myScope.WriteString ":MEASURE:VMAX?"
varQueryResult = myScope.ReadNumber ' Read Vmax.
MsgBox "Maximum voltage:" + vbCrLf + _
    FormatNumber(varQueryResult, 4) + " V"

' WAVEFORM_DATA - To obtain waveform data, you must specify the
' WAVEFORM parameters for the waveform data prior to sending the
' ":WAVEFORM:DATA?" query. Once these parameters have been sent,
' the waveform data and the preamble can be read.
'
' WAVE_SOURCE - Selects the channel to be used as the source for
' the waveform commands.
myScope.WriteString ":WAVEFORM:SOURCE CHAN1"

' WAVE_POINTS - Specifies the number of points to be transferred
' using the ":WAVEFORM:DATA?" query.
myScope.WriteString ":WAVEFORM:POINTS 1000"

' WAVE_FORMAT - Sets the data transmission mode for the waveform
' data output. This command controls whether data is formatted in
' a word or byte format when sent from the oscilloscope.
Dim lngVSteps As Long
Dim intBytesPerData As Integer

' Data in range 0 to 65535.
myScope.WriteString ":WAVEFORM:FORMAT WORD"
lngVSteps = 65536
intBytesPerData = 2

' With WORD format, use most significant byte first order.
myScope.WriteString ":WAVEform:BYTorder MSBFirst"

' Data in range 0 to 255.
myScope.WriteString ":WAVEFORM:FORMAT BYTE"
lngVSteps = 256
intBytesPerData = 1

' GET_PREAMBLE - The preamble block contains all of the current
' WAVEFORM settings. It is returned in the form <preamble_block><NL>
' where <preamble_block> is:
'   FORMAT      : int16 - 0 = BYTE, 1 = WORD, 4 = ASCII.
'   TYPE        : int16 - 0 = NORMAL, 1 = PEAK DETECT, 2 = AVERAGE.
'   POINTS     : int32 - number of data points transferred.
'   COUNT      : int32 - 1 and is always 1.

```

```

'      XINCREMENT      : float64 - time difference between data points.
'      XORIGIN         : float64 - always the first data point in memory.
'      XREFERENCE      : int32 - specifies the data point associated with
'                      x-origin.
'      YINCREMENT      : float32 - voltage difference between data points.
'      YORIGIN         : float32 - value is the voltage at center screen.
'      YREFERENCE      : int32 - specifies the data point where y-origin
'                      occurs.
Dim Preamble()
Dim intFormat As Integer
Dim intType As Integer
Dim lngPoints As Long
Dim lngCount As Long
Dim dblXIncrement As Double
Dim dblXOrigin As Double
Dim lngXReference As Long
Dim sngYIncrement As Single
Dim sngYOrigin As Single
Dim lngYReference As Long
Dim strOutput As String

myScope.WriteString ":WAVEFORM:PREAmble?" ' Query for the preamble.
Preamble() = myScope.ReadList ' Read preamble information.
intFormat = Preamble(0)
intType = Preamble(1)
lngPoints = Preamble(2)
lngCount = Preamble(3)
dblXIncrement = Preamble(4)
dblXOrigin = Preamble(5)
lngXReference = Preamble(6)
sngYIncrement = Preamble(7)
sngYOrigin = Preamble(8)
lngYReference = Preamble(9)
strOutput = ""
'strOutput = strOutput + "Format = " + CStr(intFormat) + vbCrLf
'strOutput = strOutput + "Type = " + CStr(intType) + vbCrLf
'strOutput = strOutput + "Points = " + CStr(lngPoints) + vbCrLf
'strOutput = strOutput + "Count = " + CStr(lngCount) + vbCrLf
'strOutput = strOutput + "X increment = " + _
'      FormatNumber(dblXIncrement * 1000000) + _
'      " us" + vbCrLf
'strOutput = strOutput + "X origin = " + _
'      FormatNumber(dblXOrigin * 1000000) + _
'      " us" + vbCrLf
'strOutput = strOutput + "X reference = " + _
'      CStr(lngXReference) + vbCrLf
'strOutput = strOutput + "Y increment = " + _
'      FormatNumber(sngYIncrement * 1000) + _
'      " mV" + vbCrLf
'strOutput = strOutput + "Y origin = " + _
'      FormatNumber(sngYOrigin) + " V" + vbCrLf
'strOutput = strOutput + "Y reference = " + _
'      CStr(lngYReference) + vbCrLf
strOutput = strOutput + "Volts/Div = " + _
'      FormatNumber(lngVSteps * sngYIncrement / 8) + _
'      " V" + vbCrLf
strOutput = strOutput + "Offset = " + _

```

12 Programming Examples

```
        FormatNumber(sngYOrigin) + " V" + vbCrLf
strOutput = strOutput + "Sec/Div = " + _
        FormatNumber(lngPoints * dblXIncrement / 10 * _
        1000000) + " us" + vbCrLf
strOutput = strOutput + "Delay = " + _
        FormatNumber(((lngPoints / 2) * _
        dblXIncrement + dblXOrigin) * 1000000) + " us" + vbCrLf

' QUERY_WAVE_DATA - Outputs waveform data that is stored in a buffer.

' Query the oscilloscope for the waveform data.
myScope.WriteString ":WAV:DATA?"

' READ_WAVE_DATA - The wave data consists of two parts: the header,
' and the actual waveform data followed by a new line (NL) character.
' The query data has the following format:
'
'     <header><waveform_data><NL>
'
' Where:
'     <header> = #800001000 (This is an example header)
' The "#8" may be stripped off of the header and the remaining
' numbers are the size, in bytes, of the waveform data block. The
' size can vary depending on the number of points acquired for the
' waveform. You can then read that number of bytes from the
' oscilloscope and the terminating NL character.
'
Dim lngI As Long
Dim lngDataValue As Long

' Unsigned integer bytes.
varQueryResult = myScope.ReadIEEEBlock(BinaryType_UI1)
For lngI = 0 To UBound(varQueryResult) _
    Step (UBound(varQueryResult) / 20) ' 20 points.
    If intBytesPerData = 2 Then
        lngDataValue = varQueryResult(lngI) * 256 + _
            varQueryResult(lngI + 1) ' 16-bit value.
    Else
        lngDataValue = varQueryResult(lngI) ' 8-bit value.
    End If
    strOutput = strOutput + "Data point " + _
        CStr(lngI / intBytesPerData) + ", " + _
        FormatNumber((lngDataValue - lngYReference) * sngYIncrement + _
        sngYOrigin) + " V, " + _
        FormatNumber(((lngI / intBytesPerData - lngXReference) * _
        dblXIncrement + dblXOrigin) * 1000000) + " us" + vbCrLf
Next lngI
MsgBox "Waveform data:" + vbCrLf + strOutput

' Make a delay measurement between channel 1 and 2.
Dim dblChan1Edge1 As Double
Dim dblChan2Edge1 As Double
Dim dblChan1Edge2 As Double
Dim dblDelay As Double
Dim dblPeriod As Double
Dim dblPhase As Double
```

```

' Query time at 1st rising edge on ch1.
myScope.WriteString ":MEASURE:TEDGE? +1, CHAN1"

' Read time at edge 1 on ch 1.
dblChan1Edge1 = myScope.ReadNumber

' Query time at 1st rising edge on ch2.
myScope.WriteString ":MEASURE:TEDGE? +1, CHAN2"

' Read time at edge 1 on ch 2.
dblChan2Edge1 = myScope.ReadNumber

' Calculate delay time between ch1 and ch2.
dblDelay = dblChan2Edge1 - dblChan1Edge1

' Write calculated delay time to screen.
MsgBox "Delay = " + vbCrLf + CStr(dblDelay)

' Make a phase difference measurement between channel 1 and 2.

' Query time at 1st rising edge on ch1.
myScope.WriteString ":MEASURE:TEDGE? +2, CHAN1"

' Read time at edge 2 on ch 1.
dblChan1Edge2 = myScope.ReadNumber

' Calculate period of ch 1.
dblPeriod = dblChan1Edge2 - dblChan1Edge1

' Calculate phase difference between ch1 and ch2.
dblPhase = (dblDelay / dblPeriod) * 360
MsgBox "Phase = " + vbCrLf + CStr(dblPhase)

Exit Sub

VisaComError:
MsgBox "VISA COM Error:" + vbCrLf + Err.Description

End Sub

Private Sub CheckForInstrumentErrors()

On Error GoTo VisaComError

Dim strErrVal As String
Dim strOut As String

myScope.WriteString "SYSTEM:ERROR?" ' Query any errors data.
strErrVal = myScope.ReadString ' Read: Errnum,"Error String".
While Val(strErrVal) <> 0 ' End if find: 0,"No Error".
strOut = strOut + "INST Error: " + strErrVal
myScope.WriteString ":SYSTEM:ERROR?" ' Request error message.
strErrVal = myScope.ReadString ' Read error message.
Wend

If Not strOut = "" Then
MsgBox strOut, vbExclamation, "INST Error Messages"

```

```
        myScope.FlushWrite (False)
        myScope.FlushRead

    End If

    Exit Sub

VisaComError:
    MsgBox "VISA COM Error: " + vbCrLf + Err.Description

End Sub
```

VISA COM Example in C#

To compile and run this example in Microsoft Visual Studio 2005:

- 1 Open Visual Studio.
- 2 Create a new Visual C#, Windows, Console Application project.
- 3 Cut-and-paste the code that follows into the C# source file.
- 4 Edit the program to use the VISA address of your oscilloscope.
- 5 Add a reference to the VISA COM 3.0 Type Library:
 - a Right-click the project you wish to modify (not the solution) in the Solution Explorer window of the Microsoft Visual Studio environment.
 - b Choose **Add Reference...**
 - c In the Add Reference dialog, select the **COM** tab.
 - d Select **VISA COM 3.0 Type Library**; then click **OK**.
- 6 Build and run the program.

For more information, see the VISA COM Help that comes with Agilent IO Libraries Suite 15.

```
/*
 * Agilent VISA COM Example in C#
 * -----
 * This program illustrates most of the commonly used programming
 * features of your Agilent oscilloscopes.
 * -----
 */

using System;
using System.IO;
using System.Text;
using Ivi.Visa.Interop;
using System.Runtime.InteropServices;

namespace InfiniiVision
{
    class VisaComInstrumentApp
    {
```

```

private static VisaComInstrument myScope;

public static void Main(string[] args)
{
    try
    {
        myScope = new
            VisaComInstrument("USB0::2391::5957::MY47250010::0::INSTR");

        Initialize();

        /* The extras function contains miscellaneous commands that
         * do not need to be executed for the proper operation of
         * this example. The commands in the extras function are
         * shown for reference purposes only.
         */
        // Extra(); // Uncomment to execute the extra function.
        Capture();
        Analyze();
    }
    catch (System.ApplicationException err)
    {
        Console.WriteLine("*** VISA Error Message : " + err.Message);
    }
    catch (System.SystemException err)
    {
        Console.WriteLine("*** System Error Message : " + err.Message);
    }
    catch (System.Exception err)
    {
        System.Diagnostics.Debug.Fail("Unexpected Error");
        Console.WriteLine("*** Unexpected Error : " + err.Message);
    }
    finally
    {
        myScope.Close();
    }
}

/*
 * Initialize()
 * -----
 * This function initializes both the interface and the
 * oscilloscope to a known state.
 */
private static void Initialize()
{
    string strResults;

    /* RESET - This command puts the oscilloscope into a known
     * state. This statement is very important for programs to
     * work as expected. Most of the following initialization
     * commands are initialized by *RST. It is not necessary to
     * reinitialize them unless the default setting is not suitable
     * for your application.
     */
    myScope.DoCommand("*RST"); // Reset the to the defaults.
}

```

12 Programming Examples

```
myScope.DoCommand("*CLS"); // Clear the status data structures.

/* IDN - Ask for the device's *IDN string.
 */
strResults = myScope.DoQueryString("*IDN?");

// Display results.
Console.WriteLine("Result is: {0}", strResults);

/* AUTOSCALE - This command evaluates all the input signals
 * and sets the correct conditions to display all of the
 * active signals.
 */
myScope.DoCommand(":AUToscale");

/* CHANNEL_PROBE - Sets the probe attenuation factor for the
 * selected channel. The probe attenuation factor may be from
 * 0.1 to 1000.
 */
myScope.DoCommand(":CHANnel1:PROBe 10");

/* CHANNEL_RANGE - Sets the full scale vertical range in volts.
 * The range value is eight times the volts per division.
 */
myScope.DoCommand(":CHANnel1:RANGe 8");

/* TIME_RANGE - Sets the full scale horizontal time in seconds.
 * The range value is ten times the time per division.
 */
myScope.DoCommand(":TIMebase:RANGe 2e-3");

/* TIME_REFERENCE - Possible values are LEFT and CENTER:
 * - LEFT sets the display reference one time division from
 * the left.
 * - CENTER sets the display reference to the center of the
 * screen.
 */
myScope.DoCommand(":TIMebase:REFeRence CENTER");

/* TRIGGER_SOURCE - Selects the channel that actually produces
 * the TV trigger. Any channel can be selected.
 */
myScope.DoCommand(":TRIGger:TV:SOURCe CHANnel1");

/* TRIGGER_MODE - Set the trigger mode to, EDGE, GLITCh,
 * PATtern, CAN, DURation, IIC, LIN, SEQuence, SPI, TV,
 * UART, or USB.
 */
myScope.DoCommand(":TRIGger:MODE EDGE");

/* TRIGGER_EDGE_SLOPE - Set the slope of the edge for the
 * trigger to either POSITIVE or NEGATIVE.
 */
myScope.DoCommand(":TRIGger:EDGE:SLOPe POSitive");
}

/*
```



```

* Extra()
* -----
* The commands in this function are not executed and are shown
* for reference purposes only. To execute these commands, call
* this function from main.
*/
private static void Extra()
{
    /* RUN_STOP (not executed in this example):
    * - RUN starts the acquisition of data for the active
    *   waveform display.
    * - STOP stops the data acquisition and turns off AUTOSTORE.
    */
    myScope.DoCommand(":RUN");
    myScope.DoCommand(":STOP");

    /* VIEW_BLANK (not executed in this example):
    * - VIEW turns on (starts displaying) an active channel or
    *   pixel memory.
    * - BLANK turns off (stops displaying) a specified channel or
    *   pixel memory.
    */
    myScope.DoCommand(":BLANK CHANnel1");
    myScope.DoCommand(":VIEW CHANnel1");

    /* TIME_MODE (not executed in this example) - Set the time base
    * mode to MAIN, DELAYED, XY or ROLL.
    */
    myScope.DoCommand(":TIMEbase:MODE MAIN");
}

/*
* Capture()
* -----
* This function prepares the scope for data acquisition and then
* uses the DIGITIZE MACRO to capture some data.
*/
private static void Capture()
{
    /* AQUIRE_TYPE - Sets the acquisition mode. There are three
    * acquisition types NORMAL, PEAK, or AVERAGE.
    */
    myScope.DoCommand(":ACquire:TYPE NORMal");

    /* AQUIRE_COMPLETE - Specifies the minimum completion criteria
    * for an acquisition. The parameter determines the percentage
    * of time buckets needed to be "full" before an acquisition is
    * considered to be complete.
    */
    myScope.DoCommand(":ACquire:COMplete 100");

    /* DIGITIZE - Used to acquire the waveform data for transfer
    * over the interface. Sending this command causes an
    * acquisition to take place with the resulting data being
    * placed in the buffer.
    */
}

```

```

/* NOTE! The use of the DIGITIZE command is highly recommended
 * as it will ensure that sufficient data is available for
 * measurement. Keep in mind when the oscilloscope is running,
 * communication with the computer interrupts data acquisition.
 * Setting up the oscilloscope over the bus causes the data
 * buffers to be cleared and internal hardware to be
 * reconfigured.
 * If a measurement is immediately requested there may not have
 * been enough time for the data acquisition process to collect
 * data and the results may not be accurate. An error value of
 * 9.9E+37 may be returned over the bus in this situation.
 */
myScope.DoCommand(":DIGitize CHANnel1");
}

/*
 * Analyze()
 * -----
 * In this example we will do the following:
 * - Save the system setup to a file for restoration at a later
 *   time.
 * - Save the oscilloscope display to a file which can be
 *   printed.
 * - Make single channel measurements.
 */
private static void Analyze()
{
    byte[] ResultsArray; // Results array.
    int nBytes; // Number of bytes returned from instrument.

    /* SAVE_SYSTEM_SETUP - The :SYSTEM:SETup? query returns a
     * program message that contains the current state of the
     * instrument. Its format is a definite-length binary block,
     * for example,
     * #800002204<setup string><NL>
     * where the setup string is 2204 bytes in length.
     */
    Console.WriteLine("Saving oscilloscope setup to " +
        "c:\\scope\\config\\setup.dat");
    if (File.Exists("c:\\scope\\config\\setup.dat"))
        File.Delete("c:\\scope\\config\\setup.dat");

    // Query and read setup string.
    ResultsArray = myScope.DoQueryIEEEBlock(":SYSTEM:SETup?");
    nBytes = ResultsArray.Length;
    Console.WriteLine("Read oscilloscope setup ({0} bytes).",
        nBytes);

    // Write setup string to file.
    File.WriteAllBytes("c:\\scope\\config\\setup.dat",
        ResultsArray);
    Console.WriteLine("Wrote setup string ({0} bytes) to file.",
        nBytes);

    /* RESTORE_SYSTEM_SETUP - Uploads a previously saved setup
     * string to the oscilloscope.
     */
}

```

```

byte[] dataArray;

// Read setup string from file.
dataArray = File.ReadAllBytes("c:\\scope\\config\\setup.dat");
Console.WriteLine("Read setup string ({0} bytes) from file.",
    dataArray.Length);

// Restore setup string.
myScope.DoCommandIEEEBlock(":SYSTEM:SETup", dataArray);
Console.WriteLine("Restored setup string.");

/* IMAGE_TRANSFER - In this example, we query for the screen
 * data with the ":DISPLAY:DATA?" query. The .png format
 * data is saved to a file in the local file system.
 */
Console.WriteLine("Transferring screen image to " +
    "c:\\scope\\data\\screen.png");
if (File.Exists("c:\\scope\\data\\screen.png"))
    File.Delete("c:\\scope\\data\\screen.png");

// Increase I/O timeout to fifteen seconds.
myScope.SetTimeoutSeconds(15);

// Get the screen data in PNG format.
ResultsArray = myScope.DoQueryIEEEBlock(
    ":DISPlay:DATA? PNG, SCReen, COLOr");
nBytes = ResultsArray.Length;
Console.WriteLine("Read screen image ({0} bytes).", nBytes);

// Store the screen data in a file.
File.WriteAllBytes("c:\\scope\\data\\screen.png",
    ResultsArray);
Console.WriteLine("Wrote screen image ({0} bytes) to file.",
    nBytes);

// Return I/O timeout to five seconds.
myScope.SetTimeoutSeconds(5);

/* MEASURE - The commands in the MEASURE subsystem are used to
 * make measurements on displayed waveforms.
 */

// Set source to measure.
myScope.DoCommand(":MEASure:SOURce CHANnel1");

// Query for frequency.
double fResults;
fResults = myScope.DoQueryValue(":MEASure:FREQuency?");
Console.WriteLine("The frequency is: {0:F4} kHz",
    fResults / 1000);

// Query for peak to peak voltage.
fResults = myScope.DoQueryValue(":MEASure:VPP?");
Console.WriteLine("The peak to peak voltage is: {0:F2} V",
    fResults);

/* WAVEFORM_DATA - Get waveform data from oscilloscope. To

```

12 Programming Examples

```
* obtain waveform data, you must specify the WAVEFORM
* parameters for the waveform data prior to sending the
* ":WAVEFORM:DATA?" query.
*
* Once these parameters have been sent, the
* ":WAVEFORM:PREAMBLE?" query provides information concerning
* the vertical and horizontal scaling of the waveform data.
*
* With the preamble information you can then use the
* ":WAVEFORM:DATA?" query and read the data block in the
* correct format.
*/

/* WAVE_FORMAT - Sets the data transmission mode for waveform
* data output. This command controls how the data is
* formatted when sent from the oscilloscope and can be set
* to WORD or BYTE format.
*/

// Set waveform format to BYTE.
myScope.DoCommand(":WAVEform:FORMat BYTE");

/* WAVE_POINTS - Sets the number of points to be transferred.
* The number of time points available is returned by the
* "ACQUIRE:POINTS?" query. This can be set to any binary
* fraction of the total time points available.
*/
myScope.DoCommand(":WAVEform:POINTs 1000");

/* GET_PREAMBLE - The preamble contains all of the current
* WAVEFORM settings returned in the form <preamble block><NL>
* where the <preamble block> is:
*   FORMAT      : int16 - 0 = BYTE, 1 = WORD, 4 = ASCII.
*   TYPE        : int16 - 0 = NORMAL, 1 = PEAK DETECT,
*                 2 = AVERAGE.
*   POINTS      : int32 - number of data points transferred.
*   COUNT       : int32 - 1 and is always 1.
*   XINCREMENT  : float64 - time difference between data
*                         points.
*   XORIGIN     : float64 - always the first data point in
*                         memory.
*   XREFERENCE  : int32 - specifies the data point associated
*                         with the x-origin.
*   YINCREMENT  : float32 - voltage difference between data
*                         points.
*   YORIGIN     : float32 - value of the voltage at center
*                         screen.
*   YREFERENCE  : int32 - data point where y-origin occurs.
*/
Console.WriteLine("Reading preamble.");
double[] fResultsArray;
fResultsArray = myScope.DoQueryValues(":WAVEform:PREAmble?");

double fFormat = fResultsArray[0];
Console.WriteLine("Preamble FORMat: {0:e}", fFormat);

double fType = fResultsArray[1];
```

```

Console.WriteLine("Preamble TYPE: {0:e}", fType);

double fPoints = fResultsArray[2];
Console.WriteLine("Preamble POINTs: {0:e}", fPoints);

double fCount = fResultsArray[3];
Console.WriteLine("Preamble COUNT: {0:e}", fCount);

double fXincrement = fResultsArray[4];
Console.WriteLine("Preamble XINCrement: {0:e}", fXincrement);

double fXorigin = fResultsArray[5];
Console.WriteLine("Preamble XORigin: {0:e}", fXorigin);

double fXreference = fResultsArray[6];
Console.WriteLine("Preamble XREFerence: {0:e}", fXreference);

double fYincrement = fResultsArray[7];
Console.WriteLine("Preamble YINCrement: {0:e}", fYincrement);

double fYorigin = fResultsArray[8];
Console.WriteLine("Preamble YORigin: {0:e}", fYorigin);

double fYreference = fResultsArray[9];
Console.WriteLine("Preamble YREFerence: {0:e}", fYreference);

/* QUERY_WAVE_DATA - Outputs waveform records to the controller
 * over the interface that is stored in a buffer previously
 * specified with the ":WAVEform:SOURce" command.
 */

/* READ_WAVE_DATA - The wave data consists of two parts: the
 * header, and the actual waveform data followed by a
 * New Line (NL) character. The query data has the following
 * format:
 *
 * <header><waveform data block><NL>
 *
 * Where:
 *
 * <header> = #800002048 (this is an example header)
 *
 * The "#8" may be stripped off of the header and the remaining
 * numbers are the size, in bytes, of the waveform data block.
 * The size can vary depending on the number of points acquired
 * for the waveform which can be set using the
 * ":WAVEFORM:POINTS" command. You may then read that number
 * of bytes from the oscilloscope; then, read the following NL
 * character to terminate the query.
 */

// Read waveform data.
ResultsArray = myScope.DoQueryIEEEBlock(":WAVEform:DATA?");
nBytes = ResultsArray.Length;
Console.WriteLine("Read waveform data ({0} bytes).", nBytes);

// Make some calculations from the preamble data.

```

```

double fVdiv = 32 * fYincrement;
double fOffset = fYorigin;
double fSdiv = fPoints * fXincrement / 10;
double fDelay = (fPoints / 2) * fXincrement + fXorigin;

// Print them out...
Console.WriteLine("Scope Settings for Channel 1:");
Console.WriteLine("Volts per Division = {0:f}", fVdiv);
Console.WriteLine("Offset = {0:f}", fOffset);
Console.WriteLine("Seconds per Division = {0:e}", fSdiv);
Console.WriteLine("Delay = {0:e}", fDelay);

// Print the waveform voltage at selected points:
for (int i = 0; i < nBytes; i = i + (nBytes / 20))
{
    Console.WriteLine("Data point {0:d} = {1:f6} Volts at "
        + "{2:f10} Seconds", i,
        ((float)ResultsArray[i] - fYreference) * fYincrement +
        fYorigin,
        ((float)i - fXreference) * fXincrement + fXorigin);
}

/* SAVE_WAVE_DATA - saves the waveform data to a CSV format
 * file named "waveform.csv".
 */
if (File.Exists("c:\\scope\\data\\waveform.csv"))
    File.Delete("c:\\scope\\data\\waveform.csv");

StreamWriter writer =
    File.CreateText("c:\\scope\\data\\waveform.csv");
for (int i = 0; i < nBytes; i++)
{
    writer.WriteLine("{0:E}, {1:f6}",
        ((float)i - fXreference) * fXincrement + fXorigin,
        ((float)ResultsArray[i] - fYreference) * fYincrement +
        fYorigin);
}
writer.Close();
Console.WriteLine("Waveform data ({0} points) written to " +
    "c:\\scope\\data\\waveform.csv.", nBytes);
}
}

class VisaComInstrument
{
    private ResourceManagerClass m_ResourceManager;
    private FormattedIO488Class m_IoObject;
    private string m_strVisaAddress;

    // Constructor.
    public VisaComInstrument(string strVisaAddress)
    {
        // Save VISA address in member variable.
        m_strVisaAddress = strVisaAddress;

        // Open the default VISA COM IO object.
        OpenIo();
    }
}

```

```

        // Clear the interface.
        m_IoObject.IO.Clear();
    }

    public void DoCommand(string strCommand)
    {
        // Send the command.
        m_IoObject.WriteString(strCommand, true);

        // Check for instrument errors.
        CheckForInstrumentErrors(strCommand);
    }

    public string DoQueryString(string strQuery)
    {
        // Send the query.
        m_IoObject.WriteString(strQuery, true);

        // Get the result string.
        string strResults;
        strResults = m_IoObject.ReadString();

        // Check for instrument errors.
        CheckForInstrumentErrors(strQuery);

        // Return results string.
        return strResults;
    }

    public double DoQueryValue(string strQuery)
    {
        // Send the query.
        m_IoObject.WriteString(strQuery, true);

        // Get the result number.
        double fResult;
        fResult = (double)m_IoObject.ReadNumber(
            IEEEASCIIType.ASCIIType_R8, true);

        // Check for instrument errors.
        CheckForInstrumentErrors(strQuery);

        // Return result number.
        return fResult;
    }

    public double[] DoQueryValues(string strQuery)
    {
        // Send the query.
        m_IoObject.WriteString(strQuery, true);

        // Get the result numbers.
        double[] fResultsArray;
        fResultsArray = (double[])m_IoObject.ReadList(
            IEEEASCIIType.ASCIIType_R8, ",;");
    }

```

12 Programming Examples

```
// Check for instrument errors.
CheckForInstrumentErrors(strQuery);

// Return result numbers.
return fResultsArray;
}

public byte[] DoQueryIEEEBlock(string strQuery)
{
    // Send the query.
    m_IoObject.WriteString(strQuery, true);

    // Get the results array.
    byte[] ResultsArray;
    ResultsArray = (byte[])m_IoObject.ReadIEEEBlock(
        IEEEBinaryType.BinaryType_UI1, false, true);

    // Check for instrument errors.
    CheckForInstrumentErrors(strQuery);

    // Return results array.
    return ResultsArray;
}

public void DoCommandIEEEBlock(string strCommand,
    byte[] DataArray)
{
    // Send the command.
    m_IoObject.WriteIEEEBlock(strCommand, DataArray, true);

    // Check for instrument errors.
    CheckForInstrumentErrors(strCommand);
}

private void CheckForInstrumentErrors(string strCommand)
{
    string strInstrumentError;
    bool bFirstError = true;

    // Repeat until all errors are displayed.
    do
    {
        // Send the ":SYSTEM:ERROR?" query, and get the result string.
        m_IoObject.WriteString(":SYSTEM:ERROR?", true);
        strInstrumentError = m_IoObject.ReadString();

        // If there is an error, print it.
        if (strInstrumentError.ToString() != "+0,\"No error\"\n")
        {
            if (bFirstError)
            {
                // Print the command that caused the error.
                Console.WriteLine("ERROR(s) for command '{0}': ",
                    strCommand);
                bFirstError = false;
            }
            Console.Write(strInstrumentError);
        }
    }
}
```



```

    }
    } while (strInstrumentError.ToString() != "+0, \"No error\\\"\\n\");
}

private void OpenIo()
{
    m_ResourceManager = new ResourceManagerClass();
    m_IoObject = new FormattedIO488Class();

    // Open the default VISA COM IO object.
    try
    {
        m_IoObject.IO =
            (IMessage)m_ResourceManager.Open(m_strVisaAddress,
            AccessMode.NO_LOCK, 0, "");
    }
    catch (Exception e)
    {
        Console.WriteLine("An error occurred: {0}", e.Message);
    }
}

public void SetTimeoutSeconds(int nSeconds)
{
    m_IoObject.IO.Timeout = nSeconds * 1000;
}

public void Close()
{
    try
    {
        m_IoObject.IO.Close();
    }
    catch {}

    try
    {
        Marshal.ReleaseComObject(m_IoObject);
    }
    catch {}

    try
    {
        Marshal.ReleaseComObject(m_ResourceManager);
    }
    catch {}
}
}
}

```

VISA COM Example in Visual Basic .NET

To compile and run this example in Microsoft Visual Studio 2005:

- 1 Open Visual Studio.
- 2 Create a new Visual Basic, Windows, Console Application project.
- 3 Cut-and-paste the code that follows into the C# source file.
- 4 Edit the program to use the VISA address of your oscilloscope.
- 5 Add a reference to the VISA COM 3.0 Type Library:
 - a Right-click the project you wish to modify (not the solution) in the Solution Explorer window of the Microsoft Visual Studio environment.
 - b Choose **Add Reference...**
 - c In the Add Reference dialog, select the **COM** tab.
 - d Select **VISA COM 3.0 Type Library**; then click **OK**.
 - e Right-click the project you wish to modify (not the solution) in the Solution Explorer window of the Microsoft Visual Studio environment and choose **Properties**; then, select "InfiniiVision.VisaComInstrumentApp" as the **Startup object**.
- 6 Build and run the program.

For more information, see the VISA COM Help that comes with Agilent IO Libraries Suite 15.

```
'
' Agilent VISA COM Example in Visual Basic .NET
' -----
' This program illustrates most of the commonly used programming
' features of your Agilent oscilloscopes.
' -----

Imports System
Imports System.IO
Imports System.Text
Imports Ivi.Visa.Interop
Imports System.Runtime.InteropServices

Namespace InfiniiVision
  Class VisaComInstrumentApp
    Private Shared myScope As VisaComInstrument

    Public Shared Sub Main(ByVal args As String())
      Try
        myScope = New _
          VisaComInstrument("USB0::2391::5957::MY47250010::0::INSTR")

        Initialize()

        ' The extras function contains miscellaneous commands that
```

```

' do not need to be executed for the proper operation of
' this example. The commands in the extras function are
' shown for reference purposes only.

' Extra(); // Uncomment to execute the extra function.
Capture()
Analyze()
Catch err As System.ApplicationException
    Console.WriteLine("*** VISA Error Message : " + err.Message)
Catch err As System.SystemException
    Console.WriteLine("*** System Error Message : " + err.Message)
Catch err As System.Exception
    System.Diagnostics.Debug.Fail("Unexpected Error")
    Console.WriteLine("*** Unexpected Error : " + err.Message)
Finally
    myScope.Close()
End Try
End Sub

' Initialize()
' -----
' This function initializes both the interface and the
' oscilloscope to a known state.

Private Shared Sub Initialize()
    Dim strResults As String

    ' RESET - This command puts the oscilloscope into a known
    ' state. This statement is very important for programs to
    ' work as expected. Most of the following initialization
    ' commands are initialized by *RST. It is not necessary to
    ' reinitialize them unless the default setting is not suitable
    ' for your application.

    ' Reset to the defaults.
    myScope.DoCommand("*RST")

    ' Clear the status data structures.
    myScope.DoCommand("*CLS")

    ' IDN - Ask for the device's *IDN string.
    strResults = myScope.DoQueryString("*IDN?")

    ' Display results.
    Console.WriteLine("Result is: {0}", strResults)

    ' AUTOSCALE - This command evaluates all the input signals
    ' and sets the correct conditions to display all of the
    ' active signals.
    myScope.DoCommand(":AUToscale")

    ' CHANNEL_PROBE - Sets the probe attenuation factor for the
    ' selected channel. The probe attenuation factor may be from
    ' 0.1 to 1000.
    myScope.DoCommand(":CHANnel1:PROBe 10")

    ' CHANNEL_RANGE - Sets the full scale vertical range in volts.

```

12 Programming Examples

```
' The range value is eight times the volts per division.
myScope.DoCommand(":CHANnel1:RANGe 8")

' TIME_RANGE - Sets the full scale horizontal time in seconds.
' The range value is ten times the time per division.
myScope.DoCommand(":TIMebase:RANGe 2e-3")

' TIME_REFERENCE - Possible values are LEFT and CENTER:
' - LEFT sets the display reference one time division from
'   the left.
' - CENTER sets the display reference to the center of the
'   screen.
myScope.DoCommand(":TIMebase:REFerence CENTER")

' TRIGGER_SOURCE - Selects the channel that actually produces
' the TV trigger. Any channel can be selected.
myScope.DoCommand(":TRIGger:TV:SOURCe CHANnel1")

' TRIGGER_MODE - Set the trigger mode to, EDGE, GLITCh,
' PATtern, CAN, DURation, IIC, LIN, SEQuence, SPI, TV,
' UART, or USB.
myScope.DoCommand(":TRIGger:MODE EDGE")

' TRIGGER_EDGE_SLOPE - Set the slope of the edge for the
' trigger to either POSITIVE or NEGATIVE.
myScope.DoCommand(":TRIGger:EDGE:SLOPe POSitive")

End Sub

'
' Extra()
' -----
' The commands in this function are not executed and are shown
' for reference purposes only. To execute these commands, call
' this function from main.
'

Private Shared Sub Extra()
' RUN_STOP (not executed in this example):
' - RUN starts the acquisition of data for the active
'   waveform display.
' - STOP stops the data acquisition and turns off AUTOSTORE.
'

myScope.DoCommand(":RUN")
myScope.DoCommand(":STOP")

' VIEW_BLANK (not executed in this example):
' - VIEW turns on (starts displaying) an active channel or
'   pixel memory.
' - BLANK turns off (stops displaying) a specified channel or
'   pixel memory.
'

myScope.DoCommand(":BLANk CHANnel1")
myScope.DoCommand(":VIEW CHANnel1")
```

```

' TIME_MODE (not executed in this example) - Set the time base
' mode to MAIN, DELAYED, XY or ROLL.
'
myScope.DoCommand(":TIMEbase:MODE MAIN")
End Sub

' Capture()
' -----
' This function prepares the scope for data acquisition and then
' uses the DIGITIZE MACRO to capture some data.

Private Shared Sub Capture()
' ACQUIRE_TYPE - Sets the acquisition mode. There are three
' acquisition types NORMAL, PEAK, or AVERAGE.
myScope.DoCommand(":ACquire:TYPE NORMal")

' ACQUIRE_COMPLETE - Specifies the minimum completion criteria
' for an acquisition. The parameter determines the percentage
' of time buckets needed to be "full" before an acquisition is
' considered to be complete.
myScope.DoCommand(":ACquire:COMplete 100")

' DIGITIZE - Used to acquire the waveform data for transfer
' over the interface. Sending this command causes an
' acquisition to take place with the resulting data being
' placed in the buffer.

' NOTE! The use of the DIGITIZE command is highly recommended
' as it will ensure that sufficient data is available for
' measurement. Keep in mind when the oscilloscope is running,
' communication with the computer interrupts data acquisition.
' Setting up the oscilloscope over the bus causes the data
' buffers to be cleared and internal hardware to be
' reconfigured.
' If a measurement is immediately requested there may not have
' been enough time for the data acquisition process to collect
' data and the results may not be accurate. An error value of
' 9.9E+37 may be returned over the bus in this situation.
myScope.DoCommand(":DIGitize CHANnel1")

End Sub

' Analyze()
' -----
' In this example we will do the following:
' - Save the system setup to a file for restoration at a later
'   time.
' - Save the oscilloscope display to a file which can be
'   printed.
' - Make single channel measurements.

Private Shared Sub Analyze()
' Results array.
Dim ResultsArray As Byte()

' Number of bytes returned from instrument.

```

```

Dim nBytes As Integer

' SAVE_SYSTEM_SETUP - The :SYSTEM:SETup? query returns a
' program message that contains the current state of the
' instrument. Its format is a definite-length binary block,
' for example,
' #800002204<setup string><NL>
' where the setup string is 2204 bytes in length.
Console.WriteLine("Saving oscilloscope setup to " + _
    "c:\scope\config\setup.dat")
If File.Exists("c:\scope\config\setup.dat") Then
    File.Delete("c:\scope\config\setup.dat")
End If

' Query and read setup string.
ResultsArray = myScope.DoQueryIEEEBlock(":SYSTEM:SETup?")
nBytes = ResultsArray.Length
Console.WriteLine("Read oscilloscope setup ({0} bytes).", nBytes)

' Write setup string to file.
File.WriteAllBytes("c:\scope\config\setup.dat", ResultsArray)
Console.WriteLine("Wrote setup string ({0} bytes) to file.", _
    nBytes)

' RESTORE_SYSTEM_SETUP - Uploads a previously saved setup
' string to the oscilloscope.
Dim dataArray As Byte()

' Read setup string from file.
dataArray = File.ReadAllBytes("c:\scope\config\setup.dat")
Console.WriteLine("Read setup string ({0} bytes) from file.", _
    dataArray.Length)

' Restore setup string.
myScope.DoCommandIEEEBlock(":SYSTEM:SETup", dataArray)
Console.WriteLine("Restored setup string.")

' IMAGE_TRANSFER - In this example, we query for the screen
' data with the ":DISPLAY:DATA?" query. The .png format
' data is saved to a file in the local file system.
Console.WriteLine("Transferring screen image to " + _
    "c:\scope\data\screen.png")
If File.Exists("c:\scope\data\screen.png") Then
    File.Delete("c:\scope\data\screen.png")
End If

' Increase I/O timeout to fifteen seconds.
myScope.SetTimeoutSeconds(15)

' Get the screen data in PNG format.
ResultsArray = _
    myScope.DoQueryIEEEBlock(":DISPlay:DATA? PNG, SCREen, COLor")
nBytes = ResultsArray.Length
Console.WriteLine("Read screen image ({0} bytes).", nBytes)

' Store the screen data in a file.
File.WriteAllBytes("c:\scope\data\screen.png", ResultsArray)

```

```

Console.WriteLine("Wrote screen image ({0} bytes) to file.", _
    nBytes)

' Return I/O timeout to five seconds.
myScope.SetTimeoutSeconds(5)

' MEASURE - The commands in the MEASURE subsystem are used to
' make measurements on displayed waveforms.

' Set source to measure.
myScope.DoCommand(":MEASure:SOURce CHANnel1")

' Query for frequency.
Dim fResults As Double
fResults = myScope.DoQueryValue(":MEASure:FREQuency?")
Console.WriteLine("The frequency is: {0:F4} kHz", _
    fResults / 1000)

' Query for peak to peak voltage.
fResults = myScope.DoQueryValue(":MEASure:VPP?")
Console.WriteLine("The peak to peak voltage is: {0:F2} V", _
    fResults)

' WAVEFORM_DATA - Get waveform data from oscilloscope. To
' obtain waveform data, you must specify the WAVEFORM
' parameters for the waveform data prior to sending the
' ":WAVEFORM:DATA?" query.
'
' Once these parameters have been sent, the
' ":WAVEFORM:PREAMBLE?" query provides information concerning
' the vertical and horizontal scaling of the waveform data.
'
' With the preamble information you can then use the
' ":WAVEFORM:DATA?" query and read the data block in the
' correct format.

' WAVE_FORMAT - Sets the data transmission mode for waveform
' data output. This command controls how the data is
' formatted when sent from the oscilloscope and can be set
' to WORD or BYTE format.

' Set waveform format to BYTE.
myScope.DoCommand(":WAVEform:FORMat BYTE")

' WAVE_POINTS - Sets the number of points to be transferred.
' The number of time points available is returned by the
' "ACQUIRE:POINTS?" query. This can be set to any binary
' fraction of the total time points available.
myScope.DoCommand(":WAVEform:POINTs 1000")

' GET_PREAMBLE - The preamble contains all of the current
' WAVEFORM settings returned in the form <preamble block><NL>
' where the <preamble block> is:
'   FORMAT      : int16 - 0 = BYTE, 1 = WORD, 4 = ASCII.
'   TYPE        : int16 - 0 = NORMAL, 1 = PEAK DETECT,
'               :                2 = AVERAGE.
'   POINTS      : int32 - number of data points transferred.

```

```

'   COUNT      : int32 - 1 and is always 1.
'   XINCREMENT : float64 - time difference between data
'                   points.
'   XORIGIN    : float64 - always the first data point in
'                   memory.
'   XREFERENCE : int32 - specifies the data point associated
'                   with the x-origin.
'   YINCREMENT : float32 - voltage difference between data
'                   points.
'   YORIGIN    : float32 - value of the voltage at center
'                   screen.
'   YREFERENCE : int32 - data point where y-origin occurs.

Console.WriteLine("Reading preamble.")
Dim fResultsArray As Double()
fResultsArray = myScope.DoQueryValues(":WAVEform:PREamble?")

Dim fFormat As Double = fResultsArray(0)
Console.WriteLine("Preamble FORMat: {0:e}", fFormat)

Dim fType As Double = fResultsArray(1)
Console.WriteLine("Preamble TYPE: {0:e}", fType)

Dim fPoints As Double = fResultsArray(2)
Console.WriteLine("Preamble POINTs: {0:e}", fPoints)

Dim fCount As Double = fResultsArray(3)
Console.WriteLine("Preamble COUNT: {0:e}", fCount)

Dim fXincrement As Double = fResultsArray(4)
Console.WriteLine("Preamble XINCrement: {0:e}", fXincrement)

Dim fXorigin As Double = fResultsArray(5)
Console.WriteLine("Preamble XORigin: {0:e}", fXorigin)

Dim fXreference As Double = fResultsArray(6)
Console.WriteLine("Preamble XREFerence: {0:e}", fXreference)

Dim fYincrement As Double = fResultsArray(7)
Console.WriteLine("Preamble YINCrement: {0:e}", fYincrement)

Dim fYorigin As Double = fResultsArray(8)
Console.WriteLine("Preamble YORigin: {0:e}", fYorigin)

Dim fYreference As Double = fResultsArray(9)
Console.WriteLine("Preamble YREFerence: {0:e}", fYreference)

' QUERY_WAVE_DATA - Outputs waveform records to the controller
' over the interface that is stored in a buffer previously
' specified with the ":WAVEform:SOURce" command.

' READ_WAVE_DATA - The wave data consists of two parts: the
' header, and the actual waveform data followed by a
' New Line (NL) character. The query data has the following
' format:
'
'   <header><waveform data block><NL>

```



```

'
' Where:
'
'   <header> = #800002048      (this is an example header)
'
' The "#8" may be stripped off of the header and the remaining
' numbers are the size, in bytes, of the waveform data block.
' The size can vary depending on the number of points acquired
' for the waveform which can be set using the
' ":WAVEFORM:POINTS" command. You may then read that number
' of bytes from the oscilloscope; then, read the following NL
' character to terminate the query.

' Read waveform data.
ResultsArray = myScope.DoQueryIEEEBlock(":WAVEform:DATA?")
nBytes = ResultsArray.Length
Console.WriteLine("Read waveform data ({0} bytes).", nBytes)

' Make some calculations from the preamble data.
Dim fVdiv As Double = 32 * fYincrement
Dim fOffset As Double = fYorigin
Dim fSdiv As Double = fPoints * fXincrement / 10
Dim fDelay As Double = (fPoints / 2) * fXincrement + fXorigin

' Print them out...
Console.WriteLine("Scope Settings for Channel 1:")
Console.WriteLine("Volts per Division = {0:f}", fVdiv)
Console.WriteLine("Offset = {0:f}", fOffset)
Console.WriteLine("Seconds per Division = {0:e}", fSdiv)
Console.WriteLine("Delay = {0:e}", fDelay)

' Print the waveform voltage at selected points:
Dim i As Integer = 0
While i < nBytes
    Console.WriteLine("Data point {0:d} = {1:f6} Volts at " + _
        "{2:f10} Seconds", i, _
        (CSng(ResultsArray(i)) - fYreference) * fYincrement + _
        fYorigin, (CSng(i) - fXreference) * fXincrement + fXorigin)
    i = i + (nBytes / 20)
End While

' SAVE_WAVE_DATA - saves the waveform data to a CSV format
' file named "waveform.csv".
If File.Exists("c:\scope\data\waveform.csv") Then
    File.Delete("c:\scope\data\waveform.csv")
End If

Dim writer As StreamWriter = _
    File.CreateText("c:\scope\data\waveform.csv")
For index As Integer = 0 To nBytes - 1
    writer.WriteLine("{0:E}, {1:f6}", _
        (CSng(index) - fXreference) * fXincrement + fXorigin, _
        (CSng(ResultsArray(index)) - fYreference) * fYincrement + _
        fYorigin)
Next
writer.Close()
Console.WriteLine("Waveform data ({0} points) written to " + _

```

12 Programming Examples

```
        "c:\scope\data\waveform.csv.", nBytes)
    End Sub
End Class

Class VisaComInstrument
    Private m_ResourceManager As ResourceManagerClass
    Private m_IoObject As FormattedIO488Class
    Private m_strVisaAddress As String

    ' Constructor.
    Public Sub New(ByVal strVisaAddress As String)
        ' Save VISA address in member variable.
        m_strVisaAddress = strVisaAddress

        ' Open the default VISA COM IO object.
        OpenIo()

        ' Clear the interface.
        m_IoObject.IO.Clear()
    End Sub

    Public Sub DoCommand(ByVal strCommand As String)
        ' Send the command.
        m_IoObject.WriteString(strCommand, True)

        ' Check for instrument errors.
        CheckForInstrumentErrors(strCommand)
    End Sub

    Public Function DoQueryString(ByVal strQuery As String) As String
        ' Send the query.
        m_IoObject.WriteString(strQuery, True)

        ' Get the result string.
        Dim strResults As String
        strResults = m_IoObject.ReadString()

        ' Check for instrument errors.
        CheckForInstrumentErrors(strQuery)

        ' Return results string.
        Return strResults
    End Function

    Public Function DoQueryValue(ByVal strQuery As String) As Double
        ' Send the query.
        m_IoObject.WriteString(strQuery, True)

        ' Get the result number.
        Dim fResult As Double
        fResult = _
            Cdbl(m_IoObject.ReadNumber(IEEEASCIIType.ASCIIType_R8, True))

        ' Check for instrument errors.
        CheckForInstrumentErrors(strQuery)

        ' Return result number.
    End Function
End Class
```

```

    Return fResult
End Function

Public Function DoQueryValues(ByVal strQuery As String) As Double()
    ' Send the query.
    m_IoObject.WriteString(strQuery, True)

    ' Get the result numbers.
    Dim fResultsArray As Double()
    fResultsArray = _
        m_IoObject.ReadList(IEEEASCIIType.ASCIIType_R8, ",;")

    ' Check for instrument errors.
    CheckForInstrumentErrors(strQuery)

    ' Return result numbers.
    Return fResultsArray
End Function

Public _
    Function DoQueryIEEEBlock(ByVal strQuery As String) As Byte()
    ' Send the query.
    m_IoObject.WriteString(strQuery, True)

    ' Get the results array.
    Dim ResultsArray As Byte()
    ResultsArray = _
        m_IoObject.ReadIEEEBlock(IEEEBinaryType.BinaryType_UI1, _
            False, True)

    ' Check for instrument errors.
    CheckForInstrumentErrors(strQuery)

    ' Return results array.
    Return ResultsArray
End Function

Public _
    Sub DoCommandIEEEBlock(ByVal strCommand As String, _
        ByVal dataArray As Byte())
    ' Send the command.
    m_IoObject.WriteIEEEBlock(strCommand, dataArray, True)

    ' Check for instrument errors.
    CheckForInstrumentErrors(strCommand)
End Sub

Private Sub CheckForInstrumentErrors(ByVal strCommand As String)
    Dim strInstrumentError As String
    Dim bFirstError As Boolean = True

    ' Repeat until all errors are displayed.
    Do
        ' Send the ":SYSTem:ERRor?" query, and get the result string.
        m_IoObject.WriteString(":SYSTem:ERRor?", True)
        strInstrumentError = m_IoObject.ReadString()
    
```

12 Programming Examples

```
' If there is an error, print it.
If strInstrumentError.ToString() <> "+0,"No error"" " _
    & Chr(10) & "" Then
    If bFirstError Then
        ' Print the command that caused the error.
        Console.WriteLine("ERROR(s) for command '{0}': ", _
            strCommand)
        bFirstError = False
    End If
    Console.Write(strInstrumentError)
End If
Loop While strInstrumentError.ToString() <> "+0,"No error"" " _
    & Chr(10) & ""
End Sub

Private Sub OpenIo()
    m_ResourceManager = New ResourceManagerClass()
    m_IoObject = New FormattedIO488Class()

    ' Open the default VISA COM IO object.
    Try
        m_IoObject.IO = _
            DirectCast(m_ResourceManager.Open(m_strVisaAddress, _
                AccessMode.NO_LOCK, 0, ""), IMessage)
    Catch e As Exception
        Console.WriteLine("An error occurred: {0}", e.Message)
    End Try
End Sub

Public Sub SetTimeoutSeconds(ByVal nSeconds As Integer)
    m_IoObject.IO.Timeout = nSeconds * 1000
End Sub

Public Sub Close()
    Try
        m_IoObject.IO.Close()
    Catch
    End Try

    Try
        Marshal.ReleaseComObject(m_IoObject)
    Catch
    End Try

    Try
        Marshal.ReleaseComObject(m_ResourceManager)
    Catch
    End Try
End Sub
End Class
End Namespace
```

VISA Examples

- ["VISA Example in C"](#) on page 845
- ["VISA Example in Visual Basic"](#) on page 854
- ["VISA Example in C#"](#) on page 864
- ["VISA Example in Visual Basic .NET"](#) on page 877

VISA Example in C

To compile and run this example in Microsoft Visual Studio 2005:

- 1 Open Visual Studio.
- 2 Create a new Visual C++, Win32, Win32 Console Application project.
- 3 In the Win32 Application Wizard, click **Next >**. Then, check **Empty project**, and click **Finish**.
- 4 Cut-and-paste the code that follows into a file named "example.c" in the project directory.
- 5 In Visual Studio 2005, right-click the Source Files folder, choose **Add > Add Existing Item...**, select the example.c file, and click **Add**.
- 6 Edit the program to use the VISA address of your oscilloscope.
- 7 Choose **Project > Properties...** In the Property Pages dialog, update these project settings:
 - a Under Configuration Properties, Linker, Input, add "visa32.lib" to the Additional Dependencies field.
 - b Under Configuration Properties, C/C++, Code Generation, select Multi-threaded DLL for the Runtime Library field.
 - c Click **OK** to close the Property Pages dialog.
- 8 Add the include files and library files search paths:
 - a Choose **Tools > Options...**
 - b In the Options dialog, select **VC++ Directories** under Projects and Solutions.
 - c Show directories for **Include files**, and add the include directory (for example, Program Files\VISA\winnt\include).
 - d Show directories for **Library files**, and add the library files directory (for example, Program Files\VISA\winnt\lib\msc).
 - e Click **OK** to close the Options dialog.
- 9 Build and run the program.

```
/*
 * Agilent VISA Example in C
 * -----
```

12 Programming Examples

```
* This program illustrates most of the commonly-used programming
* features of your Agilent oscilloscope.
* This program is to be built as a WIN32 console application.
* Edit the RESOURCE line to specify the address of the
* applicable device.
*/

#include <stdio.h>           /* For printf(). */
#include <visa.h>           /* Agilent VISA routines. */

/* GPIB */
/* #define RESOURCE "GPIB0::7::INSTR" */

/* LAN */
/* #define RESOURCE "TCPIP0::a-mso6102-90541::inst0::INSTR" */

/* USB */
#define RESOURCE "USB0::2391::5970::30D3090541::0::INSTR"

#define WAVE_DATA_SIZE 5000
#define TIMEOUT 5000
#define SETUP_STR_SIZE 3000
#define IMG_SIZE 300000

/* Function prototypes */
void initialize(void);      /* Initialize the oscilloscope. */
void extra(void);         /* Miscellaneous commands not executed,
                          shown for reference purposes. */
void capture(void);       /* Digitize data from oscilloscope. */
void analyze(void);       /* Make some measurements. */
void get_waveform(void);  /* Download waveform data from
                          oscilloscope. */
void save_waveform(void); /* Save waveform data to a file. */
void retrieve_waveform(void); /* Load waveform data from a file. */

/* Global variables */
ViSession defaultRM, vi;   /* Device session ID. */
char buf[256] = { 0 };    /* Buffer for IDN string. */
unsigned char waveform_data[WAVE_DATA_SIZE]; /* Array for waveform
                                              data. */
double preamble[10];      /* Array for preamble. */

void main(void)
{
    /* Open session. */
    viOpenDefaultRM(&defaultRM);
    viOpen(defaultRM, RESOURCE, VI_NULL, VI_NULL, &vi);
    printf ("Oscilloscope session initialized!\n");

    /* Clear the interface. */
    viClear(vi);

    initialize();

    /* The extras function contains miscellaneous commands that do not
     * need to be executed for the proper operation of this example.
     */
}
```

```

    * The commands in the extras function are shown for reference
    * purposes only.
    */
    /* extra(); */ /* <-- Uncomment to execute the extra function */

    capture();

    analyze();

    /* Close session */
    viClose(vi);
    viClose(defaultRM);
    printf ("Program execution is complete...\n");
}

/*
 * initialize
 * -----
 * This function initializes both the interface and the oscilloscope
 * to a known state.
 */

void initialize (void)
{
    /* RESET - This command puts the oscilloscope in a known state.
     * Without this command, the oscilloscope settings are unknown.
     * This command is very important for program control.
     *
     * Many of the following initialization commands are initialized
     * by this command. It is not necessary to reinitialize them
     * unless you want to change the default setting.
     */
    viPrintf(vi, "*RST\n");

    /* Write the *IDN? string and send an EOI indicator, then read
     * the response into buf.
    viQueryf(vi, "*IDN?\n", "%t", buf);
    printf("%s\n", buf);
    */

    /* AUTOSCALE - This command evaluates all the input signals and
     * sets the correct conditions to display all of the active signals.
     */
    viPrintf(vi, ":AUTOSCALE\n");

    /* CHANNEL_PROBE - Sets the probe attenuation factor for the
     * selected channel. The probe attenuation factor may be from
     * 0.1 to 1000.
     */
    viPrintf(vi, ":CHAN1:PROBE 10\n");

    /* CHANNEL_RANGE - Sets the full scale vertical range in volts.
     * The range value is eight times the volts per division.
     */
    viPrintf(vi, ":CHANNEL1:RANGE 8\n");

    /* TIME_RANGE - Sets the full scale horizontal time in seconds.

```

12 Programming Examples

```
    * The range value is ten times the time per division.
    */
viPrintf(vi, ":TIM:RANG 2e-3\n");

/* TIME_REFERENCE - Possible values are LEFT and CENTER:
 * - LEFT sets the display reference one time division from the
 *   left.
 * - CENTER sets the display reference to the center of the screen.
 */
viPrintf(vi, ":TIMEBASE:REFERENCE CENTER\n");

/* TRIGGER_SOURCE - Selects the channel that actually produces the
 * TV trigger. Any channel can be selected.
 */
viPrintf(vi, ":TRIGGER:TV:SOURCE CHANNEL1\n");

/* TRIGGER_MODE - Set the trigger mode to, EDGE, GLITCh, PATtern,
 * CAN, DURation, IIC, LIN, SEQuence, SPI, TV, or USB.
 */
viPrintf(vi, ":TRIGGER:MODE EDGE\n");

/* TRIGGER_EDGE_SLOPE - Set the slope of the edge for the trigger
 * to either POSITIVE or NEGATIVE.
 */
viPrintf(vi, ":TRIGGER:EDGE:SLOPE POSITIVE\n");
}

/*
 * extra
 * -----
 * The commands in this function are not executed and are shown for
 * reference purposes only. To execute these commands, call this
 * function from main.
 */

void extra (void)
{
    /* RUN_STOP (not executed in this example):
     * - RUN starts the acquisition of data for the active waveform
     *   display.
     * - STOP stops the data acquisition and turns off AUTOSTORE.
     */
    viPrintf(vi, ":RUN\n");
    viPrintf(vi, ":STOP\n");

    /* VIEW_BLANK (not executed in this example):
     * - VIEW turns on (starts displaying) an active channel or pixel
     *   memory.
     * - BLANK turns off (stops displaying) a specified channel or
     *   pixel memory.
     */
    viPrintf(vi, ":BLANK CHANNEL1\n");
    viPrintf(vi, ":VIEW CHANNEL1\n");

    /* TIME_MODE (not executed in this example) - Set the time base
     * mode to MAIN, DELAYED, XY or ROLL.
     */
}
```



```

    viPrintf(vi, ":TIMEBASE:MODE MAIN\n");
}

/*
 * capture
 * -----
 * This function prepares the scope for data acquisition and then
 * uses the DIGITIZE MACRO to capture some data.
 */

void capture (void)
{
    /* ACQUIRE_TYPE - Sets the acquisition mode. There are three
     * acquisition types NORMAL, PEAK, or AVERAGE.
     */
    viPrintf(vi, ":ACQUIRE:TYPE NORMAL\n");

    /* ACQUIRE_COMPLETE - Specifies the minimum completion criteria
     * for an acquisition. The parameter determines the percentage
     * of time buckets needed to be "full" before an acquisition is
     * considered to be complete.
     */
    viPrintf(vi, ":ACQUIRE:COMPLETE 100\n");

    /* DIGITIZE - Used to acquire the waveform data for transfer over
     * the interface. Sending this command causes an acquisition to
     * take place with the resulting data being placed in the buffer.
     */

    /* NOTE! The use of the DIGITIZE command is highly recommended
     * as it will ensure that sufficient data is available for
     * measurement. Keep in mind when the oscilloscope is running,
     * communication with the computer interrupts data acquisition.
     * Setting up the oscilloscope over the bus causes the data
     * buffers to be cleared and internal hardware to be reconfigured.
     * If a measurement is immediately requested there may not have
     * been enough time for the data acquisition process to collect
     * data and the results may not be accurate. An error value of
     * 9.9E+37 may be returned over the bus in this situation.
     */
    viPrintf(vi, ":DIGITIZE CHAN1\n");
}

/*
 * analyze
 * -----
 * In this example we will do the following:
 * - Save the system setup to a file for restoration at a later time.
 * - Save the oscilloscope display to a file which can be printed.
 * - Make single channel measurements.
 */

void analyze (void)
{
    double frequency, vpp;          /* Measurements. */
    double vdiv, off, sdiv, delay; /* Values calculated from preamble
                                     data. */

```

```

int i;                                /* Loop counter. */
unsigned char setup_string[SETUP_STR_SIZE]; /* Array for setup
                                           string. */

int setup_size;
FILE *fp;
unsigned char image_data[IMG_SIZE]; /* Array for image data. */
int img_size;

/* SAVE_SYSTEM_SETUP - The :SYSTEM:SETUP? query returns a program
 * message that contains the current state of the instrument. Its
 * format is a definite-length binary block, for example,
 * #800002204<setup string><NL>
 * where the setup string is 2204 bytes in length.
 */
setup_size = SETUP_STR_SIZE;
/* Query and read setup string. */
viQueryf(vi, ":SYSTEM:SETUP?\n", "%#b\n", &setup_size, setup_string);
printf("Read setup string query (%d bytes).\n", setup_size);
/* Write setup string to file. */
fp = fopen ("c:\\scope\\config\\setup.dat", "wb");
setup_size = fwrite(setup_string, sizeof(unsigned char), setup_size,
                    fp);
fclose (fp);
printf("Wrote setup string (%d bytes) to file.\n", setup_size);

/* RESTORE_SYSTEM_SETUP - Uploads a previously saved setup string
 * to the oscilloscope.
 */
/* Read setup string from file. */
fp = fopen ("c:\\scope\\config\\setup.dat", "rb");
setup_size = fread (setup_string, sizeof(unsigned char),
                    SETUP_STR_SIZE, fp);
fclose (fp);
printf("Read setup string (%d bytes) from file.\n", setup_size);
/* Restore setup string. */
viPrintf(vi, ":SYSTEM:SETUP #8%08d", setup_size);
viBufWrite(vi, setup_string, setup_size, &setup_size);
viPrintf(vi, "\n");
printf("Restored setup string (%d bytes).\n", setup_size);

/* IMAGE_TRANSFER - In this example we will query for the image
 * data with ":DISPLAY:DATA?" to read the data and save the data
 * to the file "image.dat" which you can then send to a printer.
 */
viSetAttribute(vi, VI_ATTR_TMO_VALUE, 30000);
printf("Transferring image to c:\\scope\\data\\screen.bmp\n");
img_size = IMG_SIZE;
viQueryf(vi, ":DISPLAY:DATA? BMP8bit, SCREEN, COLOR\n", "%#b\n",
          &img_size, image_data);
printf("Read display data query (%d bytes).\n", img_size);
/* Write image data to file. */
fp = fopen ("c:\\scope\\data\\screen.bmp", "wb");
img_size = fwrite(image_data, sizeof(unsigned char), img_size, fp);
fclose (fp);
printf("Wrote image data (%d bytes) to file.\n", img_size);
viSetAttribute(vi, VI_ATTR_TMO_VALUE, 5000);

```

```

/* MEASURE - The commands in the MEASURE subsystem are used to
 * make measurements on displayed waveforms.
 */

/* Set source to measure. */
viPrintf(vi, ":MEASURE:SOURCE CHANNEL1\n");

/* Query for frequency. */
viQueryf(vi, ":MEASURE:FREQUENCY?\n", "%lf", &frequency);
printf("The frequency is: %.4f kHz\n", frequency / 1000);

/* Query for peak to peak voltage. */
viQueryf(vi, ":MEASURE:VPP?\n", "%lf", &vpp);
printf("The peak to peak voltage is: %.2f V\n", vpp);

/* WAVEFORM_DATA - Get waveform data from oscilloscope.
 */
get_waveform();

/* Make some calculations from the preamble data. */
vdiv = 32 * preamble [7];
off = preamble [8];
sdiv = preamble [2] * preamble [4] / 10;
delay = (preamble [2] / 2) * preamble [4] + preamble [5];

/* Print them out... */
printf ("Scope Settings for Channel 1:\n");
printf ("Volts per Division = %f\n", vdiv);
printf ("Offset = %f\n", off);
printf ("Seconds per Division = %f\n", sdiv);
printf ("Delay = %f\n", delay);

/* print out the waveform voltage at selected points */
for (i = 0; i < 1000; i = i + 50)
    printf ("Data Point %4d = %6.2f Volts at %10f Seconds\n", i,
        ((float)waveform_data[i] - preamble[9]) * preamble[7] +
        preamble[8],
        ((float)i - preamble[6]) * preamble[4] + preamble[5]);

save_waveform();          /* Save waveform data to disk. */
retrieve_waveform();     /* Load waveform data from disk. */
}

/*
 * get_waveform
 * -----
 * This function transfers the data displayed on the oscilloscope to
 * the computer for storage, plotting, or further analysis.
 */

void get_waveform (void)
{
    int waveform_size;

    /* WAVEFORM_DATA - To obtain waveform data, you must specify the
     * WAVEFORM parameters for the waveform data prior to sending the
     * ":WAVEFORM:DATA?" query.

```

```

*
* Once these parameters have been sent, the ":WAVEFORM:PREAMBLE?"
* query provides information concerning the vertical and horizontal
* scaling of the waveform data.
*
* With the preamble information you can then use the
* ":WAVEFORM:DATA?" query and read the data block in the
* correct format.
*/

/* WAVE_FORMAT - Sets the data transmission mode for waveform data
* output. This command controls how the data is formatted when
* sent from the oscilloscope and can be set to WORD or BYTE format.
*/

/* Set waveform format to BYTE. */
viPrintf(vi, ":WAVEFORM:FORMAT BYTE\n");

/* WAVE_POINTS - Sets the number of points to be transferred.
* The number of time points available is returned by the
* "ACQUIRE:POINTS?" query. This can be set to any binary
* fraction of the total time points available.
*/
viPrintf(vi, ":WAVEFORM:POINTS 1000\n");

/* GET_PREAMBLE - The preamble contains all of the current WAVEFORM
* settings returned in the form <preamble block><NL> where the
* <preamble block> is:
*   FORMAT      : int16 - 0 = BYTE, 1 = WORD, 4 = ASCII.
*   TYPE        : int16 - 0 = NORMAL, 1 = PEAK DETECT, 2 = AVERAGE.
*   POINTS      : int32 - number of data points transferred.
*   COUNT       : int32 - 1 and is always 1.
*   XINCREMENT  : float64 - time difference between data points.
*   XORIGIN     : float64 - always the first data point in memory.
*   XREFERENCE  : int32 - specifies the data point associated
*                   with the x-origin.
*   YINCREMENT  : float32 - voltage difference between data points.
*   YORIGIN     : float32 - value of the voltage at center screen.
*   YREFERENCE  : int32 - data point where y-origin occurs.
*/
printf("Reading preamble\n");
viQueryf(vi, ":WAVEFORM:PREAMBLE?\n", "%,10lf\n", preamble);
/*
printf("Preamble FORMAT: %e\n", preamble[0]);
printf("Preamble TYPE: %e\n", preamble[1]);
printf("Preamble POINTS: %e\n", preamble[2]);
printf("Preamble COUNT: %e\n", preamble[3]);
printf("Preamble XINCREMENT: %e\n", preamble[4]);
printf("Preamble XORIGIN: %e\n", preamble[5]);
printf("Preamble XREFERENCE: %e\n", preamble[6]);
printf("Preamble YINCREMENT: %e\n", preamble[7]);
printf("Preamble YORIGIN: %e\n", preamble[8]);
printf("Preamble YREFERENCE: %e\n", preamble[9]);
*/

/* QUERY_WAVE_DATA - Outputs waveform records to the controller
* over the interface that is stored in a buffer previously

```

```

    * specified with the ":WAVEFORM:SOURCE" command.
    */
viPrintf(vi, ":WAVEFORM:DATA?\n"); /* Query waveform data. */

/* READ_WAVE_DATA - The wave data consists of two parts: the header,
 * and the actual waveform data followed by an New Line (NL)
 * character. The query data has the following format:
 *
 * <header><waveform data block><NL>
 *
 * Where:
 *
 * <header> = #800002048 (this is an example header)
 *
 * The "#8" may be stripped off of the header and the remaining
 * numbers are the size, in bytes, of the waveform data block.
 * The size can vary depending on the number of points acquired
 * for the waveform which can be set using the ":WAVEFORM:POINTS"
 * command. You may then read that number of bytes from the
 * oscilloscope; then, read the following NL character to
 * terminate the query.
 */
waveform_size = WAVE_DATA_SIZE;
/* Read waveform data. */
viScanf(vi, "%#b\n", &waveform_size, waveform_data);
if ( waveform_size == WAVE_DATA_SIZE )
{
    printf("Waveform data buffer full: ");
    printf("May not have received all points.\n");
}
else
{
    printf("Reading waveform data... size = %d\n", waveform_size);
}
}

/*
 * save_waveform
 * -----
 * This function saves the waveform data from the get_waveform
 * function to disk. The data is saved to a file called "wave.dat".
 */

void save_waveform(void)
{
    FILE *fp;

    fp = fopen("c:\\scope\\data\\wave.dat", "wb");
    /* Write preamble. */
    fwrite(preamble, sizeof(preamble[0]), 10, fp);
    /* Write actually waveform data. */
    fwrite(waveform_data, sizeof(waveform_data[0]), (int)preamble[2],
           fp);
    fclose(fp);
}

/*

```

```

* retrieve_waveform
* -----
* This function retrieves previously saved waveform data from a
* file called "wave.dat".
*/

void retrieve_waveform(void)
{
    FILE *fp;

    fp = fopen("c:\\scope\\data\\wave.dat", "rb");
    /* Read preamble. */
    fread(preamble, sizeof(preamble[0]), 10, fp);
    /* Read the waveform data. */
    fread(waveform_data, sizeof(waveform_data[0]), (int)preamble[2],
        fp);
    fclose(fp);
}

```

VISA Example in Visual Basic

To run this example in Visual Basic for Applications:

- 1 Start the application that provides Visual Basic for Applications (for example, Microsoft Excel).
- 2 Press ALT+F11 to launch the Visual Basic editor.
- 3 Add the visa32.bas file to your project:
 - a Choose **File>Import File...**
 - b Navigate to the header file, visa32.bas (installed with Agilent IO Libraries Suite and found in the Program Files\VISA\winnt\include directory), select it, and click **Open**.
- 4 Choose **Insert>Module**.
- 5 Cut-and-paste the code that follows into the editor.
- 6 Edit the program to use the VISA address of your oscilloscope, and save the changes.
- 7 Run the program.

```

'
' Agilent VISA Example in Visual Basic
' -----
' This program illustrates a few commonly-used programming
' features of your Agilent oscilloscope.
' -----

Option Explicit

Public err As Long ' Error returned by VISA function calls.
Public drm As Long ' Session to Default Resource Manager.
Public vi As Long ' Session to instrument.

```

```

' Declare variables to hold numeric values returned by
' viVScanf/viVQueryf.
Public dblQueryResult As Double
Public Const ByteArraySize = 5000000
Public retCount As Long
Public byteArray(ByteArraySize) As Byte
Public paramsArray(2) As Long
Public Const DblArraySize = 20
Public dblArray(DblArraySize) As Double

' Declare fixed length string variable to hold string value returned
' by viVScanf/viVQueryf.
Public strQueryResult As String * 200

' For Sleep subroutine.
Private Declare Sub Sleep Lib "kernel32" (ByVal dwMilliseconds As Long)

'
' Main Program
' -----

Sub Main()

    ' Open the default resource manager session.
    err = viOpenDefaultRM(drm)
    If (err <> VI_SUCCESS) Then HandleVISAError drm

    ' Open the session using the oscilloscope's VISA address.
    err = viOpen(drm, _
        "USB0::2391::5970::30D3090541::0::INSTR", 0, 15000, vi)
    If (err <> VI_SUCCESS) Then HandleVISAError drm

    ' Initialize - start from a known state.
    Initialize

    ' Capture data.
    Capture

    ' Analyze the captured waveform.
    Analyze

    ' Close the vi session and the resource manager session.
    err = viClose(vi)
    err = viClose(drm)

End Sub

'
' Initialize the oscilloscope to a known state.
' -----

Private Sub Initialize()

    ' Clear the interface.
    err = viClear(vi)
    If Not (err = VI_SUCCESS) Then HandleVISAError vi

```

12 Programming Examples

```
' Get and display the device's *IDN? string.
strQueryResult = DoQueryString("*IDN?")
MsgBox "*IDN? string: " + strQueryResult, vbOKOnly, "*IDN? Result"

' Clear status and load the default setup.
DoCommand "*CLS"
DoCommand "*RST"

End Sub

'
' Capture the waveform.
' -----

Private Sub Capture()

' Set probe attenuation factor (from 0.1 to 1000).
' -----
DoCommand ":CHANnel1:PROBe 10"
Debug.Print "Channel 1 probe attenuation factor: " + _
    DoQueryString(":CHANnel1:PROBe?")

' Use auto-scale to automatically configure oscilloscope.
' -----
DoCommand ":AUToscale"

' Set the trigger mode to EDGE.
DoCommand ":TRIGger:MODE EDGE"
Debug.Print "Trigger mode: " + _
    DoQueryString(":TRIGger:MODE?")

' Set EDGE trigger parameters.
DoCommand ":TRIGger:EDGE:SOURCe CHANnel1"
Debug.Print "Trigger edge source: " + _
    DoQueryString(":TRIGger:EDGE:SOURce?")

DoCommand ":TRIGger:EDGE:LEVel 1.5"
Debug.Print "Trigger edge level: " + _
    DoQueryString(":TRIGger:EDGE:LEVel?")

DoCommand ":TRIGger:EDGE:SLOPe POSitive"
Debug.Print "Trigger edge slope: " + _
    DoQueryString(":TRIGger:EDGE:SLOPe?")

' Save oscilloscope configuration.
' -----
Dim lngSetupStringSize As Long
lngSetupStringSize = DoQueryIIEEEBlock_Bytes(":SYSTem:SETup?")
Debug.Print "Setup bytes saved: " + CStr(lngSetupStringSize)

' Output setup string to a file:
Dim strPath As String
strPath = "c:\scope\config\setup.dat"
If Len(Dir(strPath)) Then
    Kill strPath ' Remove file if it exists.
End If
```



```

' Open file for output.
Dim hFile As Long
hFile = FreeFile
Open strPath For Binary Access Write Lock Write As hFile
Dim lngI As Long
For lngI = 0 To lngSetupStringSize - 1
  Put hFile, , byteArray(lngI) ' Write data.
Next lngI
Close hFile ' Close file.

' Change settings with individual commands:
' -----

' Set vertical scale and offset.
DoCommand ":CHANnel1:SCALE 0.05"
Debug.Print "Channel 1 vertical scale: " + _
  DoQueryString(":CHANnel1:SCALE?")

DoCommand ":CHANnel1:OFFSet -1.5"
Debug.Print "Channel 1 vertical offset: " + _
  DoQueryString(":CHANnel1:OFFSet?")

' Set horizontal scale and offset.
DoCommand ":TIMEbase:SCALE 0.0002"
Debug.Print "Timebase scale: " + _
  DoQueryString(":TIMEbase:SCALE?")

DoCommand ":TIMEbase:POSition 0.0"
Debug.Print "Timebase position: " + _
  DoQueryString(":TIMEbase:POSition?")

' Set the acquisition type to NORMAL.
DoCommand ":ACQuire:TYPE NORMAL"
Debug.Print "Acquire type: " + _
  DoQueryString(":ACQuire:TYPE?")

' Or, configure by loading a previously saved setup.
' -----
strPath = "c:\scope\config\setup.dat"
Open strPath For Binary Access Read As hFile ' Open file for input.
Dim lngSetupFileSize As Long
lngSetupFileSize = LOF(hFile) ' Length of file.
Get hFile, , byteArray ' Read data.
Close hFile ' Close file.
' Write learn string back to oscilloscope using ":SYSTEM:SETup"
' command:
Dim lngRestored As Long
lngRestored = DoCommandIEEEBlock(":SYSTEM:SETup", lngSetupFileSize)
Debug.Print "Setup bytes restored: " + CStr(lngRestored)

' Capture data using :DIGitize.
' -----
DoCommand ":DIGitize"

End Sub

```

12 Programming Examples

```
' Analyze the captured waveform.
' -----

Private Sub Analyze()

    ' Make a couple of measurements.
    ' -----
    DoCommand ":MEASure:SOURce CHANnel1"
    Debug.Print "Measure source: " + _
        DoQueryString(":MEASure:SOURce?")

    DoCommand ":MEASure:VAMPlitude"
    dblQueryResult = DoQueryNumber(":MEASure:VAMPlitude?")
    MsgBox "Vertial amplitude:" + vbCrLf + _
        FormatNumber(dblQueryResult, 4) + " V"

    DoCommand ":MEASure:FREQuency"
    dblQueryResult = DoQueryNumber(":MEASure:FREQuency?")
    MsgBox "Frequency:" + vbCrLf + _
        FormatNumber(dblQueryResult / 1000, 4) + " kHz"

    ' Download the screen image.
    ' -----
    ' Get screen image.
    Dim lngBlockSize As Long
    lngBlockSize = _
        DoQueryIEEEBlock_Bytes(":DISPlay:DATA? PNG, SCREEN, COLOR")
    Debug.Print "Screen image bytes: " + CStr(lngBlockSize)

    ' Save screen image to a file:
    Dim strPath As String
    strPath = "c:\scope\data\screen.png"
    If Len(Dir(strPath)) Then
        Kill strPath ' Remove file if it exists.
    End If
    Dim hFile As Long
    hFile = FreeFile
    Open strPath For Binary Access Write Lock Write As hFile
    Dim lngI As Long
    For lngI = 0 To lngBlockSize - 1
        Put hFile, , byteArray(lngI) ' Write data.
    Next lngI
    Close hFile ' Close file.
    MsgBox "Screen image written to " + strPath

    ' Download waveform data.
    ' -----

    ' Set the waveform points mode.
    DoCommand ":WAVEform:POINts:MODE RAW"
    Debug.Print "Waveform points mode: " + _
        DoQueryString(":WAVEform:POINts:MODE?")

    ' Set the desired number of waveform points.
    DoCommand ":WAVEform:POINts 1000"
```

```

Debug.Print "Waveform points desired: " + _
    DoQueryString(":WAVEform:POINTs?")

' Set the waveform source.
DoCommand ":WAVEform:SOURce CHANnel1"
Debug.Print "Waveform source: " + _
    DoQueryString(":WAVEform:SOURce?")

' Choose the format of the data returned (WORD, BYTE, ASCII):
DoCommand ":WAVEform:FORMat BYTE"
Debug.Print "Waveform format: " + _
    DoQueryString(":WAVEform:FORMat?")

' Display the waveform settings:
Dim intFormat As Integer
Dim intType As Integer
Dim lngPoints As Long
Dim lngCount As Long
Dim dblXIncrement As Double
Dim dblXOrigin As Double
Dim lngXReference As Long
Dim sngYIncrement As Single
Dim sngYOrigin As Single
Dim lngYReference As Long
Dim strOutput As String

Dim lngNumNumbers As Long
lngNumNumbers = DoQueryNumbers(":WAVEform:PREAmble?")

intFormat = dblArray(0)
intType = dblArray(1)
lngPoints = dblArray(2)
lngCount = dblArray(3)
dblXIncrement = dblArray(4)
dblXOrigin = dblArray(5)
lngXReference = dblArray(6)
sngYIncrement = dblArray(7)
sngYOrigin = dblArray(8)
lngYReference = dblArray(9)

If intFormat = 0 Then
    Debug.Print "Waveform format: BYTE"
ElseIf intFormat = 1 Then
    Debug.Print "Waveform format: WORD"
ElseIf intFormat = 4 Then
    Debug.Print "Waveform format: ASCii"
End If

If intType = 0 Then
    Debug.Print "Acquisition type: NORMAL"
ElseIf intType = 1 Then
    Debug.Print "Acquisition type: PEAK"
ElseIf intType = 2 Then
    Debug.Print "Acquisition type: AVERAGE"
End If

Debug.Print "Waveform points desired: " + _

```

12 Programming Examples

```
        FormatNumber(lngPoints, 0)

Debug.Print "Waveform average count: " + _
    FormatNumber(lngCount, 0)

Debug.Print "Waveform X increment: " + _
    Format(dblXIncrement, "Scientific")

Debug.Print "Waveform X origin: " + _
    Format(dblXOrigin, "Scientific")

Debug.Print "Waveform X reference: " + _
    FormatNumber(lngXReference, 0)

Debug.Print "Waveform Y increment: " + _
    Format(sngYIncrement, "Scientific")

Debug.Print "Waveform Y origin: " + _
    Format(sngYOrigin, "Scientific")

Debug.Print "Waveform Y reference: " + _
    FormatNumber(lngYReference, 0)

' Get the waveform data
Dim lngNumBytes As Long
lngNumBytes = DoQueryIEEEBlock_Bytes(":WAVEform:DATA?")
Debug.Print "Number of data values: " + CStr(lngNumBytes)

' Set up output file:
strPath = "c:\scope\data\waveform_data.csv"

' Open file for output.
Open strPath For Output Access Write Lock Write As hFile

' Output waveform data in CSV format.
Dim lngDataValue As Long

For lngI = 0 To lngNumBytes - 1
    lngDataValue = CLng(byteArray(lngI))

    ' Write time value, voltage value.
    Print #hFile, _
        Format((lngI - lngXReference) * dblXIncrement + _
            dblXOrigin, "Scientific") + ", " + _
        FormatNumber((lngDataValue - lngYReference) * _
            sngYIncrement + sngYOrigin)

Next lngI

' Close output file.
Close hFile ' Close file.
MsgBox "Waveform format BYTE data written to " + _
    "c:\scope\data\waveform_data.csv."

End Sub

Private Sub DoCommand(command As String)
```

```

err = viVPrintf(vi, command + vbLf, 0)
If (err <> VI_SUCCESS) Then HandleVISAError vi

CheckInstrumentErrors

End Sub

Private Function DoCommandIEEEBlock(command As String, _
    lngBlockSize As Long)

retCount = lngBlockSize

Dim strCommandAndLength As String
strCommandAndLength = command + " %#" + _
    Format(lngBlockSize) + "b"

err = viVPrintf(vi, strCommandAndLength + vbLf, paramsArray(1))
If (err <> VI_SUCCESS) Then HandleVISAError vi

DoCommandIEEEBlock = retCount

CheckInstrumentErrors

End Function

Private Function DoQueryString(query As String) As String

Dim strResult As String * 200

err = viVPrintf(vi, query + vbLf, 0)
If (err <> VI_SUCCESS) Then HandleVISAError vi

err = viVScanf(vi, "%t", strResult)
If (err <> VI_SUCCESS) Then HandleVISAError vi

DoQueryString = strResult

CheckInstrumentErrors

End Function

Private Function DoQueryNumber(query As String) As Variant

Dim dblResult As Double

err = viVPrintf(vi, query + vbLf, 0)
If (err <> VI_SUCCESS) Then HandleVISAError vi

err = viVScanf(vi, "%lf" + vbLf, VarPtr(dblResult))
If (err <> VI_SUCCESS) Then HandleVISAError vi

DoQueryNumber = dblResult

CheckInstrumentErrors

End Function

```

12 Programming Examples

```
Private Function DoQueryNumbers(query As String) As Long

    Dim dblResult As Double

    ' Send query.
    err = viVPrintf(vi, query + vbLf, 0)
    If (err <> VI_SUCCESS) Then HandleVISAError vi

    ' Set up paramsArray for multiple parameter query returning array.
    paramsArray(0) = VarPtr(retCount)
    paramsArray(1) = VarPtr(dblArray(0))

    ' Set retCount to max number of elements array can hold.
    retCount = DblArraySize

    ' Read numbers.
    err = viVScanf(vi, "%,#lf" + vbLf, paramsArray(0))
    If (err <> VI_SUCCESS) Then HandleVISAError vi

    ' retCount is now actual number of values returned by query.
    DoQueryNumbers = retCount

    CheckInstrumentErrors

End Function
```

```
Private Function DoQueryIEEEBlock_Bytes(query As String) As Long

    ' Send query.
    err = viVPrintf(vi, query + vbLf, 0)
    If (err <> VI_SUCCESS) Then HandleVISAError vi

    ' Set up paramsArray for multiple parameter query returning array.
    paramsArray(0) = VarPtr(retCount)
    paramsArray(1) = VarPtr(byteArray(0))

    ' Set retCount to max number of elements array can hold.
    retCount = ByteArraySize

    ' Get unsigned integer bytes.
    Sleep 2000 ' Delay before reading data.
    err = viVScanf(vi, "%#b" + vbLf, paramsArray(0))
    If (err <> VI_SUCCESS) Then HandleVISAError vi

    err = viFlush(vi, VI_READ_BUF)
    If (err <> VI_SUCCESS) Then HandleVISAError vi

    err = viFlush(vi, VI_WRITE_BUF)
    If (err <> VI_SUCCESS) Then HandleVISAError vi

    ' retCount is now actual number of bytes returned by query.
    DoQueryIEEEBlock_Bytes = retCount

    CheckInstrumentErrors

End Function
```

```

Private Sub CheckInstrumentErrors()

    On Error GoTo ErrorHandler

    Dim strErrVal As String * 200
    Dim strOut As String

    err = viVPrintf(vi, ":SYSTem:ERRor?" + vbLf, 0) ' Query any errors.
    If (err <> VI_SUCCESS) Then HandleVISAError vi

    err = viVScanf(vi, "%t", strErrVal) ' Read: Errnum,"Error String".
    If (err <> VI_SUCCESS) Then HandleVISAError vi

    While Val(strErrVal) <> 0 ' End if find: 0,"No Error".
        strOut = strOut + "INST Error: " + strErrVal

        err = viVPrintf(vi, ":SYSTem:ERRor?" + vbLf, 0) ' Request error.
        If (err <> VI_SUCCESS) Then HandleVISAError vi

        err = viVScanf(vi, "%t", strErrVal) ' Read error message.
        If (err <> VI_SUCCESS) Then HandleVISAError vi

    Wend

    If Not strOut = "" Then
        MsgBox strOut, vbExclamation, "INST Error Messages"

        err = viFlush(vi, VI_READ_BUF)
        If (err <> VI_SUCCESS) Then HandleVISAError vi

        err = viFlush(vi, VI_WRITE_BUF)
        If (err <> VI_SUCCESS) Then HandleVISAError vi

    End If

    Exit Sub

ErrorHandler:

    MsgBox "*** Error : " + Error, vbExclamation
    End

End Sub

Private Sub HandleVISAError(session As Long)

    Dim strVisaErr As String * 200
    Call viStatusDesc(session, err, strVisaErr)
    MsgBox "*** VISA Error : " + strVisaErr, vbExclamation

    ' If the error is not a warning, close the session.
    If err < VI_SUCCESS Then
        If session <> 0 Then Call viClose(session)
        End
    End If
End Sub

```

End Sub

VISA Example in C#

To compile and run this example in Microsoft Visual Studio 2005:

- 1 Open Visual Studio.
- 2 Create a new Visual C#, Windows, Console Application project.
- 3 Cut-and-paste the code that follows into the C# source file.
- 4 Edit the program to use the VISA address of your oscilloscope.
- 5 Add Agilent's VISA header file to your project:
 - a Right-click the project you wish to modify (not the solution) in the Solution Explorer window of the Microsoft Visual Studio environment.
 - b Click **Add** and then click **Add Existing Item...**
 - c Navigate to the header file, visa32.cs (installed with Agilent IO Libraries Suite and found in the Program Files\VISA\winnt\include directory), select it, but *do not click the Open button*.
 - d Click the down arrow to the right of the **Add** button, and choose **Add as Link**.

You should now see the file underneath your project in the Solution Explorer. It will have a little arrow icon in its lower left corner, indicating that it is a link.

- 6 Build and run the program.

For more information, see the tutorial on using VISA in Microsoft .NET in the VISA Help that comes with Agilent IO Libraries Suite 15.

```
/*
 * Agilent VISA Example in C#
 * -----
 * This program illustrates most of the commonly used programming
 * features of your Agilent oscilloscopes.
 * -----
 */

using System;
using System.IO;
using System.Text;

namespace InfiniiVision
{
    class VisaInstrumentApp
    {
        private static VisaInstrument oscp;

        public static void Main(string[] args)
```



```

{
    try
    {
        oscp = new
            VisaInstrument("USB0::2391::5957::MY47250010::0::INSTR");

        Initialize();

        /* The extras function contains miscellaneous commands that
         * do not need to be executed for the proper operation of
         * this example. The commands in the extras function are
         * shown for reference purposes only.
         */
        /*
        // Extra();    // Uncomment to execute the extra function.
        Capture();
        Analyze();
        */
    }
    catch (System.ApplicationException err)
    {
        Console.WriteLine("*** VISA Error Message : " + err.Message);
    }
    catch (System.SystemException err)
    {
        Console.WriteLine("*** System Error Message : " + err.Message);
    }
    catch (System.Exception err)
    {
        System.Diagnostics.Debug.Fail("Unexpected Error");
        Console.WriteLine("*** Unexpected Error : " + err.Message);
    }
    finally
    {
        oscp.Close();
    }
}

/*
 * Initialize()
 * -----
 * This function initializes both the interface and the
 * oscilloscope to a known state.
 */
private static void Initialize()
{
    StringBuilder strResults;

    /* RESET - This command puts the oscilloscope into a known
     * state. This statement is very important for programs to
     * work as expected. Most of the following initialization
     * commands are initialized by *RST. It is not necessary to
     * reinitialize them unless the default setting is not suitable
     * for your application.
     */
    oscp.DoCommand("*RST");    // Reset the to the defaults.
    oscp.DoCommand("*CLS");    // Clear the status data structures.

    /* IDN - Ask for the device's *IDN string.

```

12 Programming Examples

```
*/
strResults = oscp.DoQueryString("*IDN?");

// Display results.
Console.WriteLine("Result is: {0}", strResults);

/* AUTOSCALE - This command evaluates all the input signals
 * and sets the correct conditions to display all of the
 * active signals.
 */
oscp.DoCommand(":AUToscale");

/* CHANNEL_PROBE - Sets the probe attenuation factor for the
 * selected channel. The probe attenuation factor may be from
 * 0.1 to 1000.
 */
oscp.DoCommand(":CHANnel1:PROBe 10");

/* CHANNEL_RANGE - Sets the full scale vertical range in volts.
 * The range value is eight times the volts per division.
 */
oscp.DoCommand(":CHANnel1:RANGE 8");

/* TIME_RANGE - Sets the full scale horizontal time in seconds.
 * The range value is ten times the time per division.
 */
oscp.DoCommand(":TIMEbase:RANGE 2e-3");

/* TIME_REFERENCE - Possible values are LEFT and CENTER:
 * - LEFT sets the display reference one time division from
 *   the left.
 * - CENTER sets the display reference to the center of the
 *   screen.
 */
oscp.DoCommand(":TIMEbase:REFerence CENTER");

/* TRIGGER_SOURCE - Selects the channel that actually produces
 * the TV trigger. Any channel can be selected.
 */
oscp.DoCommand(":TRIGger:TV:SOURCe CHANnel1");

/* TRIGGER_MODE - Set the trigger mode to, EDGE, GLITCh,
 * PATTErn, CAN, DURation, IIC, LIN, SEQUence, SPI, TV,
 * UART, or USB.
 */
oscp.DoCommand(":TRIGger:MODE EDGE");

/* TRIGGER_EDGE_SLOPE - Set the slope of the edge for the
 * trigger to either POSITIVE or NEGATIVE.
 */
oscp.DoCommand(":TRIGger:EDGE:SLOPe POSitive");
}

/*
 * Extra()
 * -----
 * The commands in this function are not executed and are shown
```

```

* for reference purposes only. To execute these commands, call
* this function from main.
*/
private static void Extra()
{
    /* RUN_STOP (not executed in this example):
    * - RUN starts the acquisition of data for the active
    *   waveform display.
    * - STOP stops the data acquisition and turns off AUTOSTORE.
    */
    oscp.DoCommand(":RUN");
    oscp.DoCommand(":STOP");

    /* VIEW_BLANK (not executed in this example):
    * - VIEW turns on (starts displaying) an active channel or
    *   pixel memory.
    * - BLANK turns off (stops displaying) a specified channel or
    *   pixel memory.
    */
    oscp.DoCommand(":BLANK CHANnel1");
    oscp.DoCommand(":VIEW CHANnel1");

    /* TIME_MODE (not executed in this example) - Set the time base
    * mode to MAIN, DELAYED, XY or ROLL.
    */
    oscp.DoCommand(":TIMEbase:MODE MAIN");
}

/*
* Capture()
* -----
* This function prepares the scope for data acquisition and then
* uses the DIGITIZE MACRO to capture some data.
*/
private static void Capture()
{
    /* ACQUIRE_TYPE - Sets the acquisition mode. There are three
    * acquisition types NORMAL, PEAK, or AVERAGE.
    */
    oscp.DoCommand(":ACquire:TYPE NORMal");

    /* ACQUIRE_COMPLETE - Specifies the minimum completion criteria
    * for an acquisition. The parameter determines the percentage
    * of time buckets needed to be "full" before an acquisition is
    * considered to be complete.
    */
    oscp.DoCommand(":ACquire:COMPLETE 100");

    /* DIGITIZE - Used to acquire the waveform data for transfer
    * over the interface. Sending this command causes an
    * acquisition to take place with the resulting data being
    * placed in the buffer.
    */

    /* NOTE! The use of the DIGITIZE command is highly recommended
    * as it will ensure that sufficient data is available for
    * measurement. Keep in mind when the oscilloscope is running,

```

```

    * communication with the computer interrupts data acquisition.
    * Setting up the oscilloscope over the bus causes the data
    * buffers to be cleared and internal hardware to be
    * reconfigured.
    * If a measurement is immediately requested there may not have
    * been enough time for the data acquisition process to collect
    * data and the results may not be accurate. An error value of
    * 9.9E+37 may be returned over the bus in this situation.
    */
    oscp.DoCommand(":DIGitize CHANnel1");
}

/*
 * Analyze()
 * -----
 * In this example we will do the following:
 * - Save the system setup to a file for restoration at a later
 *   time.
 * - Save the oscilloscope display to a file which can be
 *   printed.
 * - Make single channel measurements.
 */
private static void Analyze()
{
    byte[] ResultsArray; // Results array.
    int nLength; // Number of bytes returned from instrument.

    /* SAVE_SYSTEM_SETUP - The :SYSTEM:SETup? query returns a
     * program message that contains the current state of the
     * instrument. Its format is a definite-length binary block,
     * for example,
     * #800002204<setup string><NL>
     * where the setup string is 2204 bytes in length.
     */
    Console.WriteLine("Saving oscilloscope setup to " +
        "c:\\scope\\config\\setup.dat");
    if (File.Exists("c:\\scope\\config\\setup.dat"))
        File.Delete("c:\\scope\\config\\setup.dat");

    // Query and read setup string.
    nLength = oscp.DoQueryIEEEBlock(":SYSTEM:SETup?",
        out ResultsArray);
    Console.WriteLine("Read oscilloscope setup ({0} bytes).",
        nLength);

    // Write setup string to file.
    File.WriteAllBytes("c:\\scope\\config\\setup.dat",
        ResultsArray);
    Console.WriteLine("Wrote setup string ({0} bytes) to file.",
        nLength);

    /* RESTORE_SYSTEM_SETUP - Uploads a previously saved setup
     * string to the oscilloscope.
     */
    byte[] DataArray;
    int nBytesWritten;

```

```

// Read setup string from file.
dataArray = File.ReadAllBytes("c:\\scope\\config\\setup.dat");
Console.WriteLine("Read setup string ({0} bytes) from file.",
    dataArray.Length);

// Restore setup string.
nBytesWritten = oscp.DoCommandIEEEBlock(":SYSTEM:SETup",
    dataArray);
Console.WriteLine("Restored setup string ({0} bytes).",
    nBytesWritten);

/* IMAGE_TRANSFER - In this example, we query for the screen
 * data with the ":DISPLAY:DATA?" query. The .png format
 * data is saved to a file in the local file system.
 */
Console.WriteLine("Transferring screen image to " +
    "c:\\scope\\data\\screen.png");
if (File.Exists("c:\\scope\\data\\screen.png"))
    File.Delete("c:\\scope\\data\\screen.png");

// Increase I/O timeout to fifteen seconds.
oscp.SetTimeoutSeconds(15);

// Get the screen data in PNG format.
nLength = oscp.DoQueryIEEEBlock(
    ":DISPlay:DATA? PNG, SCReen, COLOr", out ResultsArray);
Console.WriteLine("Read screen image ({0} bytes).", nLength);

// Store the screen data in a file.
File.WriteAllBytes("c:\\scope\\data\\screen.png",
    ResultsArray);
Console.WriteLine("Wrote screen image ({0} bytes) to file.",
    nLength);

// Return I/O timeout to five seconds.
oscp.SetTimeoutSeconds(5);

/* MEASURE - The commands in the MEASURE subsystem are used to
 * make measurements on displayed waveforms.
 */

// Set source to measure.
oscp.DoCommand(":MEASure:SOURce CHANnel1");

// Query for frequency.
double fResults;
fResults = oscp.DoQueryValue(":MEASure:FREQuency?");
Console.WriteLine("The frequency is: {0:F4} kHz",
    fResults / 1000);

// Query for peak to peak voltage.
fResults = oscp.DoQueryValue(":MEASure:VPP?");
Console.WriteLine("The peak to peak voltage is: {0:F2} V",
    fResults);

/* WAVEFORM_DATA - Get waveform data from oscilloscope. To
 * obtain waveform data, you must specify the WAVEFORM

```

```

* parameters for the waveform data prior to sending the
* ":WAVEFORM:DATA?" query.
*
* Once these parameters have been sent, the
* ":WAVEFORM:PREAMBLE?" query provides information concerning
* the vertical and horizontal scaling of the waveform data.
*
* With the preamble information you can then use the
* ":WAVEFORM:DATA?" query and read the data block in the
* correct format.
*/

/* WAVE_FORMAT - Sets the data transmission mode for waveform
* data output. This command controls how the data is
* formatted when sent from the oscilloscope and can be set
* to WORD or BYTE format.
*/

// Set waveform format to BYTE.
oscp.DoCommand(":WAVEform:FORMat BYTE");

/* WAVE_POINTS - Sets the number of points to be transferred.
* The number of time points available is returned by the
* "ACQUIRE:POINTS?" query. This can be set to any binary
* fraction of the total time points available.
*/
oscp.DoCommand(":WAVEform:POINTs 1000");

/* GET_PREAMBLE - The preamble contains all of the current
* WAVEFORM settings returned in the form <preamble block><NL>
* where the <preamble block> is:
*   FORMAT      : int16 - 0 = BYTE, 1 = WORD, 4 = ASCII.
*   TYPE        : int16 - 0 = NORMAL, 1 = PEAK DETECT,
*               2 = AVERAGE.
*   POINTS      : int32 - number of data points transferred.
*   COUNT       : int32 - 1 and is always 1.
*   XINCREMENT  : float64 - time difference between data
*                       points.
*   XORIGIN     : float64 - always the first data point in
*                       memory.
*   XREFERENCE  : int32 - specifies the data point associated
*                       with the x-origin.
*   YINCREMENT  : float32 - voltage difference between data
*                       points.
*   YORIGIN     : float32 - value of the voltage at center
*                       screen.
*   YREFERENCE  : int32 - data point where y-origin occurs.
*/
Console.WriteLine("Reading preamble.");
double[] fResultsArray;
fResultsArray = oscp.DoQueryValues(":WAVEform:PREAmble?");

double fFormat = fResultsArray[0];
Console.WriteLine("Preamble FORMat: {0:e}", fFormat);

double fType = fResultsArray[1];
Console.WriteLine("Preamble TYPE: {0:e}", fType);

```

```

double fPoints = fResultsArray[2];
Console.WriteLine("Preamble POINTs: {0:e}", fPoints);

double fCount = fResultsArray[3];
Console.WriteLine("Preamble COUNT: {0:e}", fCount);

double fXincrement = fResultsArray[4];
Console.WriteLine("Preamble XINCrement: {0:e}", fXincrement);

double fXorigin = fResultsArray[5];
Console.WriteLine("Preamble XORigin: {0:e}", fXorigin);

double fXreference = fResultsArray[6];
Console.WriteLine("Preamble XREFerence: {0:e}", fXreference);

double fYincrement = fResultsArray[7];
Console.WriteLine("Preamble YINCrement: {0:e}", fYincrement);

double fYorigin = fResultsArray[8];
Console.WriteLine("Preamble YORigin: {0:e}", fYorigin);

double fYreference = fResultsArray[9];
Console.WriteLine("Preamble YREFerence: {0:e}", fYreference);

/* QUERY_WAVE_DATA - Outputs waveform records to the controller
 * over the interface that is stored in a buffer previously
 * specified with the ":WAVEform:SOURce" command.
 */

/* READ_WAVE_DATA - The wave data consists of two parts: the
 * header, and the actual waveform data followed by a
 * New Line (NL) character. The query data has the following
 * format:
 *
 * <header><waveform data block><NL>
 *
 * Where:
 *
 * <header> = #800002048 (this is an example header)
 *
 * The "#8" may be stripped off of the header and the remaining
 * numbers are the size, in bytes, of the waveform data block.
 * The size can vary depending on the number of points acquired
 * for the waveform which can be set using the
 * ":WAVEFORM:POINTS" command. You may then read that number
 * of bytes from the oscilloscope; then, read the following NL
 * character to terminate the query.
 */

// Read waveform data.
nLength = oscp.DoQueryIEEEBlock(":WAVEform:DATA?",
    out ResultsArray);
Console.WriteLine("Read waveform data ({0} bytes).", nLength);

// Make some calculations from the preamble data.
double fVdiv = 32 * fYincrement;

```

```

double fOffset = fYorigin;
double fSdiv = fPoints * fXincrement / 10;
double fDelay = (fPoints / 2) * fXincrement + fXorigin;

// Print them out...
Console.WriteLine("Scope Settings for Channel 1:");
Console.WriteLine("Volts per Division = {0:f}", fVdiv);
Console.WriteLine("Offset = {0:f}", fOffset);
Console.WriteLine("Seconds per Division = {0:e}", fSdiv);
Console.WriteLine("Delay = {0:e}", fDelay);

// Print the waveform voltage at selected points:
for (int i = 0; i < 1000; i = i + 50)
    Console.WriteLine("Data point {0:d} = {1:f2} Volts at "
        + "{2:f10} Seconds", i,
        ((float)ResultsArray[i] - fYreference) * fYincrement +
        fYorigin,
        ((float)i - fXreference) * fXincrement + fXorigin);

/* SAVE_WAVE_DATA - saves the waveform data to a CSV format
 * file named "waveform.csv".
 */
if (File.Exists("c:\\scope\\data\\waveform.csv"))
    File.Delete("c:\\scope\\data\\waveform.csv");

StreamWriter writer =
    File.CreateText("c:\\scope\\data\\waveform.csv");
for (int i = 0; i < 1000; i++)
    writer.WriteLine("{0:E}, {1:f6}",
        ((float)i - fXreference) * fXincrement + fXorigin,
        ((float)ResultsArray[i] - fYreference) * fYincrement +
        fYorigin);
writer.Close();
}
}

class VisaInstrument
{
    private int m_nResourceManager;
    private int m_nSession;
    private string m_strVisaAddress;

    // Constructor.
    public VisaInstrument(string strVisaAddress)
    {
        // Save VISA address in member variable.
        m_strVisaAddress = strVisaAddress;

        // Open the default VISA resource manager.
        OpenResourceManager();

        // Open a VISA resource session.
        OpenSession();

        // Clear the interface.
        int nViStatus;
        nViStatus = visa32.viClear(m_nSession);
    }
}

```



```

}

public void DoCommand(string strCommand)
{
    // Send the command.
    VisaSendCommandOrQuery(strCommand);

    // Check for instrument errors (another command and result).
    CheckForInstrumentErrors(strCommand);
}

public int DoCommandIEEEBlock(string strCommand,
    byte[] DataArray)
{
    // Send the command to the device.
    string strCommandAndLength;
    int nViStatus, nLength, nBytesWritten;

    nLength = DataArray.Length;
    strCommandAndLength = String.Format("{0} #8{1:D8}",
        strCommand, nLength);

    // Write first part of command to formatted I/O write buffer.
    nViStatus = visa32.viPrintf(m_nSession, strCommandAndLength);
    CheckVisaStatus(nViStatus);

    // Write the data to the formatted I/O write buffer.
    nViStatus = visa32.viBufWrite(m_nSession, DataArray, nLength,
        out nBytesWritten);
    CheckVisaStatus(nViStatus);

    // Write command termination character.
    nViStatus = visa32.viPrintf(m_nSession, "\n");
    CheckVisaStatus(nViStatus);

    // Check for instrument errors (another command and result).
    CheckForInstrumentErrors(strCommand);

    return nBytesWritten;
}

public StringBuilder DoQueryString(string strQuery)
{
    // Send the query.
    VisaSendCommandOrQuery(strQuery);

    // Get the result string.
    StringBuilder strResults = new StringBuilder(1000);
    strResults = VisaGetResultString();

    // Check for instrument errors (another command and result).
    CheckForInstrumentErrors(strQuery);

    // Return string results.
    return strResults;
}

```

```

public double DoQueryValue(string strQuery)
{
    // Send the query.
    VisaSendCommandOrQuery(strQuery);

    // Get the result string.
    double fResults;
    fResults = VisaGetResultValue();

    // Check for instrument errors (another command and result).
    CheckForInstrumentErrors(strQuery);

    // Return string results.
    return fResults;
}

public double[] DoQueryValues(string strQuery)
{
    // Send the query.
    VisaSendCommandOrQuery(strQuery);

    // Get the result string.
    double[] fResultsArray;
    fResultsArray = VisaGetResultValues();

    // Check for instrument errors (another command and result).
    CheckForInstrumentErrors(strQuery);

    // Return string results.
    return fResultsArray;
}

public int DoQueryIEEEBlock(string strQuery,
    out byte[] ResultsArray)
{
    // Send the query.
    VisaSendCommandOrQuery(strQuery);

    // Get the result string.
    int length; // Number of bytes returned from instrument.
    length = VisaGetResultIEEEBlock(out ResultsArray);

    // Check for instrument errors (another command and result).
    CheckForInstrumentErrors(strQuery);

    // Return string results.
    return length;
}

private void CheckForInstrumentErrors(string strCommand)
{
    // Check for instrument errors.
    StringBuilder strInstrumentError = new StringBuilder(1000);
    bool bFirstError = true;
    do
    {
        VisaSendCommandOrQuery(":SYSTem:ERRor?");
    }
}

```

```

        strInstrumentError = VisaGetResultString();

        if (strInstrumentError.ToString() != "+0,\"No error\"\n")
        {
            if (bFirstError)
            {
                Console.WriteLine("ERROR(s) for command '{0}': ",
                    strCommand);
                bFirstError = false;
            }
            Console.Write(strInstrumentError);
        }
    } while (strInstrumentError.ToString() != "+0,\"No error\"\n");
}

private void VisaSendCommandOrQuery(string strCommandOrQuery)
{
    // Send command or query to the device.
    string strWithNewline;
    strWithNewline = String.Format("{0}\n", strCommandOrQuery);
    int nViStatus;
    nViStatus = visa32.viPrintf(m_nSession, strWithNewline);
    CheckVisaStatus(nViStatus);
}

private StringBuilder VisaGetResultString()
{
    StringBuilder strResults = new StringBuilder(1000);

    // Read return value string from the device.
    int nViStatus;
    nViStatus = visa32.viScanf(m_nSession, "%1000t", strResults);
    CheckVisaStatus(nViStatus);

    return strResults;
}

private double VisaGetResultValue()
{
    double fResults = 0;

    // Read return value string from the device.
    int nViStatus;
    nViStatus = visa32.viScanf(m_nSession, "%lf", out fResults);
    CheckVisaStatus(nViStatus);

    return fResults;
}

private double[] VisaGetResultValues()
{
    double[] fResultsArray;
    fResultsArray = new double[10];

    // Read return value string from the device.
    int nViStatus;
    nViStatus = visa32.viScanf(m_nSession, "%,10lf\n",

```

12 Programming Examples

```
        fResultsArray);
    CheckVisaStatus(nViStatus);

    return fResultsArray;
}

private int VisaGetResultIEEEBlock(out byte[] ResultsArray)
{
    // Results array, big enough to hold a PNG.
    ResultsArray = new byte[300000];
    int length; // Number of bytes returned from instrument.

    // Set the default number of bytes that will be contained in
    // the ResultsArray to 300,000 (300kB).
    length = 300000;

    // Read return value string from the device.
    int nViStatus;
    nViStatus = visa32.viScanf(m_nSession, "%#b", ref length,
        ResultsArray);
    CheckVisaStatus(nViStatus);

    // Write and read buffers need to be flushed after IEEE block?
    nViStatus = visa32.viFlush(m_nSession, visa32.VI_WRITE_BUF);
    CheckVisaStatus(nViStatus);
    nViStatus = visa32.viFlush(m_nSession, visa32.VI_READ_BUF);
    CheckVisaStatus(nViStatus);

    return length;
}

private void OpenResourceManager()
{
    int nViStatus;
    nViStatus =
        visa32.viOpenDefaultRM(out this.m_nResourceManager);
    if (nViStatus < visa32.VI_SUCCESS)
        throw new
            ApplicationException("Failed to open Resource Manager");
}

private void OpenSession()
{
    int nViStatus;
    nViStatus = visa32.viOpen(this.m_nResourceManager,
        this.m_strVisaAddress, visa32.VI_NO_LOCK,
        visa32.VI_TMO_IMMEDIATE, out this.m_nSession);
    CheckVisaStatus(nViStatus);
}

public void SetTimeoutSeconds(int nSeconds)
{
    int nViStatus;
    nViStatus = visa32.viSetAttribute(this.m_nSession,
        visa32.VI_ATTR_TMO_VALUE, nSeconds * 1000);
    CheckVisaStatus(nViStatus);
}
```

```

public void CheckVisaStatus(int nViStatus)
{
    // If VISA error, throw exception.
    if (nViStatus < visa32.VI_SUCCESS)
    {
        StringBuilder strError = new StringBuilder(256);
        visa32.viStatusDesc(this.m_nResourceManager, nViStatus,
            strError);
        throw new ApplicationException(strError.ToString());
    }
}

public void Close()
{
    if (m_nSession != 0)
        visa32.viClose(m_nSession);
    if (m_nResourceManager != 0)
        visa32.viClose(m_nResourceManager);
}
}
}

```

VISA Example in Visual Basic .NET

To compile and run this example in Microsoft Visual Studio 2005:

- 1 Open Visual Studio.
- 2 Create a new Visual Basic, Windows, Console Application project.
- 3 Cut-and-paste the code that follows into the Visual Basic .NET source file.
- 4 Edit the program to use the VISA address of your oscilloscope.
- 5 Add Agilent's VISA header file to your project:
 - a Right-click the project you wish to modify (not the solution) in the Solution Explorer window of the Microsoft Visual Studio environment.
 - b Choose **Add** and then choose **Add Existing Item...**
 - c Navigate to the header file, visa32.vb (installed with Agilent IO Libraries Suite and found in the Program Files\VISA\winnt\include directory), select it, but *do not click the Open button*.
 - d Click the down arrow to the right of the **Add** button, and choose **Add as Link**.

You should now see the file underneath your project in the Solution Explorer. It will have a little arrow icon in its lower left corner, indicating that it is a link.

 - e Right-click the project again and choose **Properties**; then, select "InfiniiVision.VisaInstrumentApp" as the **Startup object**.

6 Build and run the program.

For more information, see the tutorial on using VISA in Microsoft .NET in the VISA Help that comes with Agilent IO Libraries Suite 15.

```
'
' Agilent VISA Example in Visual Basic .NET
' -----
' This program illustrates most of the commonly-used programming
' features of your Agilent oscilloscope.
' -----

Imports System
Imports System.IO
Imports System.Text

Namespace InfiniiVision
  Class VisaInstrumentApp
    Private Shared oscp As VisaInstrument

    Public Shared Sub Main(ByVal args As String())
      Try
        oscp = _
          New VisaInstrument("USB0::2391::5957::MY47250010::0::INSTR")

        Initialize()

        ' The extras function contains miscellaneous commands that
        ' do not need to be executed for the proper operation of
        ' this example. The commands in the extras function are
        ' shown for reference purposes only.

        ' Extra() ' Uncomment to execute the extra function.
        Capture()
        Analyze()
      Catch err As System.ApplicationException
        MsgBox("*** Error : " & err.Message, vbExclamation, _
          "VISA Error Message")
        Exit Sub
      Catch err As System.SystemException
        MsgBox("*** Error : " & err.Message, vbExclamation, _
          "System Error Message")
        Exit Sub
      Catch err As System.Exception
        Debug.Fail("Unexpected Error")
        MsgBox("*** Error : " & err.Message, vbExclamation, _
          "Unexpected Error")
        Exit Sub
      Finally
        oscp.Close()
      End Try
    End Sub

    ' Initialize()
    ' -----
    ' This function initializes both the interface and the
    ' oscilloscope to a known state.
```

```

Private Shared Sub Initialize()
    Dim strResults As StringBuilder

    ' RESET - This command puts the oscilloscope into a known
    ' state. This statement is very important for programs to
    ' work as expected. Most of the following initialization
    ' commands are initialized by *RST. It is not necessary to
    ' reinitialize them unless the default setting is not suitable
    ' for your application.

    ' Reset the to the defaults.
    oscp.DoCommand("*RST")
    ' Clear the status data structures.
    oscp.DoCommand("*CLS")

    ' IDN - Ask for the device's *IDN string.
    strResults = oscp.DoQueryString("*IDN?")
    ' Display results.
    Console.WriteLine("Result is: {0}", strResults)

    ' AUTOSCALE - This command evaluates all the input signals
    ' and sets the correct conditions to display all of the
    ' active signals.
    oscp.DoCommand(":AUToscale")

    ' CHANNEL_PROBE - Sets the probe attenuation factor for the
    ' selected channel. The probe attenuation factor may be from
    ' 0.1 to 1000.
    oscp.DoCommand(":CHANnel1:PROBe 10")

    ' CHANNEL_RANGE - Sets the full scale vertical range in volts.
    ' The range value is eight times the volts per division.
    oscp.DoCommand(":CHANnel1:RANGe 8")

    ' TIME_RANGE - Sets the full scale horizontal time in seconds.
    ' The range value is ten times the time per division.
    oscp.DoCommand(":TIMEbase:RANGe 2e-3")

    ' TIME_REFERENCE - Possible values are LEFT and CENTER:
    ' - LEFT sets the display reference one time division from
    ' the left.
    ' - CENTER sets the display reference to the center of the
    ' screen.
    oscp.DoCommand(":TIMEbase:REFerence CENTer")

    ' TRIGGER_SOURCE - Selects the channel that actually produces
    ' the TV trigger. Any channel can be selected.
    oscp.DoCommand(":TRIGger:TV:SOURCe CHANnel1")

    ' TRIGGER_MODE - Set the trigger mode to, EDGE, GLITCh,
    ' PATTern, CAN, DURation, IIC, LIN, SEQuence, SPI, TV,
    ' UART, or USB.
    oscp.DoCommand(":TRIGger:MODE EDGE")

    ' TRIGGER_EDGE_SLOPE - Set the slope of the edge for the
    ' trigger to either POSITIVE or NEGATIVE.

```

12 Programming Examples

```
    oscp.DoCommand(":TRIGger:EDGE:SLOPe POSitive")

End Sub

' Extra()
' -----
' The commands in this function are not executed and are shown
' for reference purposes only. To execute these commands, call
' this function from main.

Private Shared Sub Extra()

    ' RUN_STOP (not executed in this example):
    ' - RUN starts the acquisition of data for the active
    '   waveform display.
    ' - STOP stops the data acquisition and turns off AUTOSTORE.
    oscp.DoCommand(":RUN")
    oscp.DoCommand(":STOP")

    ' VIEW_BLANK (not executed in this example):
    ' - VIEW turns on (starts displaying) an active channel or
    '   pixel memory.
    ' - BLANK turns off (stops displaying) a specified channel or
    '   pixel memory.
    oscp.DoCommand(":BLANK CHANnel1")
    oscp.DoCommand(":VIEW CHANnel1")

    ' TIME_MODE (not executed in this example) - Set the time base
    ' mode to MAIN, DELAYED, XY or ROLL.
    oscp.DoCommand(":TIMEbase:MODE MAIN")

End Sub

' Capture()
' -----
' This function prepares the scope for data acquisition and then
' uses the DIGITIZE MACRO to capture some data.

Private Shared Sub Capture()

    ' ACQUIRE_TYPE - Sets the acquisition mode. There are three
    ' acquisition types NORMAL, PEAK, or AVERAGE.
    oscp.DoCommand(":ACQuire:TYPE NORMal")

    ' ACQUIRE_COMPLETE - Specifies the minimum completion criteria
    ' for an acquisition. The parameter determines the percentage
    ' of time buckets needed to be "full" before an acquisition is
    ' considered to be complete.
    oscp.DoCommand(":ACQuire:COMplete 100")

    ' DIGITIZE - Used to acquire the waveform data for transfer
    ' over the interface. Sending this command causes an
    ' acquisition to take place with the resulting data being
    ' placed in the buffer.

    ' NOTE! The use of the DIGITIZE command is highly recommended
```



```

' as it will ensure that sufficient data is available for
' measurement. Keep in mind when the oscilloscope is running,
' communication with the computer interrupts data acquisition.
' Setting up the oscilloscope over the bus causes the data
' buffers to be cleared and internal hardware to be
' reconfigured.
' If a measurement is immediately requested there may not have
' been enough time for the data acquisition process to collect
' data and the results may not be accurate. An error value of
' 9.9E+37 may be returned over the bus in this situation.
'
'
' oscp.DoCommand(":DIGitize CHANnel1")
End Sub

' Analyze()
' -----
' In this example we will do the following:
' - Save the system setup to a file for restoration at a later
'   time.
' - Save the oscilloscope display to a file which can be
'   printed.
' - Make single channel measurements.

Private Shared Sub Analyze()

' Results array.
Dim ResultsArray As Byte()
' Number of bytes returned from instrument.
Dim nLength As Integer

' SAVE_SYSTEM_SETUP - The :SYSTEM:SETup? query returns a
' program message that contains the current state of the
' instrument. Its format is a definite-length binary block,
' for example,
' #800002204<setup string><NL>
' where the setup string is 2204 bytes in length.
Console.WriteLine("Saving oscilloscope setup to " & _
    + "c:\scope\config\setup.dat")
If File.Exists("c:\scope\config\setup.dat") Then
    File.Delete("c:\scope\config\setup.dat")
End If

' Query and read setup string.
nLength = oscp.DoQueryIEEEBlock(":SYSTEM:SETup?", ResultsArray)
Console.WriteLine("Read oscilloscope setup ({0} bytes).", _
    nLength)

' Write setup string to file.
File.WriteAllBytes("c:\scope\config\setup.dat", ResultsArray)
Console.WriteLine("Wrote setup string ({0} bytes) to file.", _
    nLength)

' RESTORE_SYSTEM_SETUP - Uploads a previously saved setup
' string to the oscilloscope.
Dim dataArray As Byte()
Dim nBytesWritten As Integer

```

```

' Read setup string from file.
dataArray = File.ReadAllBytes("c:\scope\config\setup.dat")
Console.WriteLine("Read setup string ({0} bytes) from file.", _
    dataArray.Length)

' Restore setup string.
nBytesWritten = oscp.DoCommandIEEEBlock(":SYSTem:SETup", _
    dataArray)
Console.WriteLine("Restored setup string ({0} bytes).", _
    nBytesWritten)

' IMAGE_TRANSFER - In this example, we query for the screen
' data with the ":DISPLAY:DATA?" query. The .png format
' data is saved to a file in the local file system.
Console.WriteLine("Transferring screen image to " _
    + "c:\scope\data\screen.png")
If File.Exists("c:\scope\data\screen.png") Then
    File.Delete("c:\scope\data\screen.png")
End If

' Increase I/O timeout to fifteen seconds.
oscp.SetTimeoutSeconds(15)

' Get the screen data in PNG format.
nLength = _
    oscp.DoQueryIEEEBlock(":DISPlay:DATA? PNG, SCReen, COLor", _
        resultsArray)
Console.WriteLine("Read screen image ({0} bytes).", nLength)

' Store the screen data in a file.
File.WriteAllBytes("c:\scope\data\screen.png", resultsArray)
Console.WriteLine("Wrote screen image ({0} bytes) to file.", _
    nLength)

' Return I/O timeout to five seconds.
oscp.SetTimeoutSeconds(5)

' MEASURE - The commands in the MEASURE subsystem are used to
' make measurements on displayed waveforms.

' Set source to measure.
oscp.DoCommand(":MEASure:SOURce CHANnel1")

' Query for frequency.
Dim fResults As Double
fResults = oscp.DoQueryValue(":MEASure:FREQuency?")
Console.WriteLine("The frequency is: {0:F4} kHz", _
    fResults / 1000)

' Query for peak to peak voltage.
fResults = oscp.DoQueryValue(":MEASure:VPP?")
Console.WriteLine("The peak to peak voltage is: {0:F2} V", _
    fResults)

' WAVEFORM_DATA - Get waveform data from oscilloscope. To
' obtain waveform data, you must specify the WAVEFORM

```

```

' parameters for the waveform data prior to sending the
' ":WAVEFORM:DATA?" query.
'
' Once these parameters have been sent, the
' ":WAVEFORM:PREAMBLE?" query provides information concerning
' the vertical and horizontal scaling of the waveform data.
'
' With the preamble information you can then use the
' ":WAVEFORM:DATA?" query and read the data block in the
' correct format.

' WAVE_FORMAT - Sets the data transmission mode for waveform
' data output. This command controls how the data is
' formatted when sent from the oscilloscope and can be set
' to WORD or BYTE format.

' Set waveform format to BYTE.
oscp.DoCommand(":WAVEform:FORMat BYTE")

' WAVE_POINTS - Sets the number of points to be transferred.
' The number of time points available is returned by the
' "ACQUIRE:POINTS?" query. This can be set to any binary
' fraction of the total time points available.
oscp.DoCommand(":WAVEform:POINTs 1000")

' GET_PREAMBLE - The preamble contains all of the current
' WAVEFORM settings returned in the form <preamble block><NL>
' where the <preamble block> is:
'   FORMAT      : int16 - 0 = BYTE, 1 = WORD, 4 = ASCII.
'   TYPE        : int16 - 0 = NORMAL, 1 = PEAK DETECT,
'               :             2 = AVERAGE.
'   POINTS      : int32 - number of data points transferred.
'   COUNT       : int32 - 1 and is always 1.
'   XINCREMENT  : float64 - time difference between data
'                       points.
'   XORIGIN     : float64 - always the first data point in
'                       memory.
'   XREFERENCE  : int32 - specifies the data point associated
'                       with the x-origin.
'   YINCREMENT  : float32 - voltage difference between data
'                       points.
'   YORIGIN     : float32 - value of the voltage at center
'                       screen.
'   YREFERENCE  : int32 - data point where y-origin occurs.
Console.WriteLine("Reading preamble.")
Dim fResultsArray As Double()
fResultsArray = oscp.DoQueryValues(":WAVEform:PREAmble?")

Dim fFormat As Double = fResultsArray(0)
Console.WriteLine("Preamble FORMat: {0:e}", fFormat)

Dim fType As Double = fResultsArray(1)
Console.WriteLine("Preamble TYPE: {0:e}", fType)

Dim fPoints As Double = fResultsArray(2)
Console.WriteLine("Preamble POINTs: {0:e}", fPoints)

```

12 Programming Examples

```
Dim fCount As Double = fResultsArray(3)
Console.WriteLine("Preamble COUNT: {0:e}", fCount)

Dim fXincrement As Double = fResultsArray(4)
Console.WriteLine("Preamble XINcrement: {0:e}", fXincrement)

Dim fXorigin As Double = fResultsArray(5)
Console.WriteLine("Preamble XORigin: {0:e}", fXorigin)

Dim fXreference As Double = fResultsArray(6)
Console.WriteLine("Preamble XREFerence: {0:e}", fXreference)

Dim fYincrement As Double = fResultsArray(7)
Console.WriteLine("Preamble YINcrement: {0:e}", fYincrement)

Dim fYorigin As Double = fResultsArray(8)
Console.WriteLine("Preamble YORigin: {0:e}", fYorigin)

Dim fYreference As Double = fResultsArray(9)
Console.WriteLine("Preamble YREFerence: {0:e}", fYreference)

' QUERY_WAVE_DATA - Outputs waveform records to the controller
' over the interface that is stored in a buffer previously
' specified with the ":WAVEform:SOURce" command.

' READ_WAVE_DATA - The wave data consists of two parts: the
' header, and the actual waveform data followed by a
' New Line (NL) character. The query data has the following
' format:
'
'     <header><waveform data block><NL>
'
' Where:
'
'     <header> = #800002048      (this is an example header)
'
' The "#8" may be stripped off of the header and the remaining
' numbers are the size, in bytes, of the waveform data block.
' The size can vary depending on the number of points acquired
' for the waveform which can be set using the
' ":WAVEFORM:POINTS" command. You may then read that number
' of bytes from the oscilloscope; then, read the following NL
' character to terminate the query.

' Read waveform data.
nLength = oscp.DoQueryIEEEBlock(":WAVEform:DATA?", ResultsArray)
Console.WriteLine("Read waveform data ({0} bytes).", nLength)

' Make some calculations from the preamble data.
Dim fVdiv As Double = 32 * fYincrement
Dim fOffset As Double = fYorigin
Dim fSdiv As Double = fPoints * fXincrement / 10
Dim fDelay As Double = (fPoints / 2) * fXincrement + fXorigin

' Print them out...
Console.WriteLine("Scope Settings for Channel 1:")
Console.WriteLine("Volts per Division = {0:f}", fVdiv)
```

```

Console.WriteLine("Offset = {0:f}", fOffset)
Console.WriteLine("Seconds per Division = {0:e}", fSdiv)
Console.WriteLine("Delay = {0:e}", fDelay)

' Print the waveform voltage at selected points:
Dim i As Integer = 0
While i < 1000
    Console.WriteLine("Data point {0:d} = {1:f2} Volts at " + _
        "{2:f10} Seconds", i, _
        (CSng(ResultsArray(i)) - fYreference) * fYincrement + _
        fYorigin, _
        (CSng(i) - fXreference) * fXincrement + fXorigin)
    i = i + 50
End While

' SAVE_WAVE_DATA - saves the waveform data to a CSV format
' file named "waveform.csv".
If File.Exists("c:\scope\data\waveform.csv") Then
    File.Delete("c:\scope\data\waveform.csv")
End If

Dim writer As StreamWriter = _
    File.CreateText("c:\scope\data\waveform.csv")
For index As Integer = 0 To 999
    writer.WriteLine("{0:E}, {1:f6}", _
        (CSng(index) - fXreference) * fXincrement + fXorigin, _
        (CSng(ResultsArray(index)) - fYreference) * fYincrement _
        + fYorigin)
Next
writer.Close()
End Sub
End Class

Class VisaInstrument
Private m_nResourceManager As Integer
Private m_nSession As Integer
Private m_strVisaAddress As String

' Constructor.
Public Sub New(ByVal strVisaAddress As String)
    ' Save VISA address in member variable.
    m_strVisaAddress = strVisaAddress

    ' Open the default VISA resource manager.
    OpenResourceManager()

    ' Open a VISA resource session.
    OpenSession()

    ' Clear the interface.
    Dim nViStatus As Integer
    nViStatus = visa32.viClear(m_nSession)
End Sub

Public Sub DoCommand(ByVal strCommand As String)
    ' Send the command.
    VisaSendCommandOrQuery(strCommand)

```

12 Programming Examples

```
' Check for instrument errors (another command and result).
CheckForInstrumentErrors(strCommand)
End Sub

Public Function DoCommandIEEEBlock(ByVal strCommand As String, _
    ByVal dataArray As Byte()) As Integer
    ' Send the command to the device.
    Dim strCommandAndLength As String
    Dim nViStatus As Integer
    Dim nLength As Integer
    Dim nBytesWritten As Integer

    nLength = dataArray.Length
    strCommandAndLength = [String].Format("{0} #8{1:D8}", _
        strCommand, nLength)

    ' Write first part of command to formatted I/O write buffer.
    nViStatus = visa32.viPrintf(m_nSession, strCommandAndLength)
    CheckVisaStatus(nViStatus)

    ' Write the data to the formatted I/O write buffer.
    nViStatus = visa32.viBufWrite(m_nSession, dataArray, nLength, _
        nBytesWritten)
    CheckVisaStatus(nViStatus)

    ' Write command termination character.
    nViStatus = visa32.viPrintf(m_nSession, "" & Chr(10) & "")
    CheckVisaStatus(nViStatus)

    ' Check for instrument errors (another command and result).
    CheckForInstrumentErrors(strCommand)

    Return nBytesWritten
End Function

Public Function DoQueryString(ByVal strQuery As String) _
    As StringBuilder
    ' Send the query.
    VisaSendCommandOrQuery(strQuery)

    ' Get the result string.
    Dim strResults As New StringBuilder(1000)
    strResults = VisaGetResultString()

    ' Check for instrument errors (another command and result).
    CheckForInstrumentErrors(strQuery)

    ' Return string results.
    Return strResults
End Function

Public Function DoQueryValue(ByVal strQuery As String) As Double
    ' Send the query.
    VisaSendCommandOrQuery(strQuery)

    ' Get the result string.
```

```

Dim fResults As Double
fResults = VisaGetResultValue()

' Check for instrument errors (another command and result).
CheckForInstrumentErrors(strQuery)

' Return string results.
Return fResults
End Function

Public Function DoQueryValues(ByVal strQuery As String) As Double()
' Send the query.
VisaSendCommandOrQuery(strQuery)

' Get the result string.
Dim fResultsArray As Double()
fResultsArray = VisaGetResultValues()

' Check for instrument errors (another command and result).
CheckForInstrumentErrors(strQuery)

' Return string results.
Return fResultsArray
End Function

Public Function DoQueryIEEEBlock(ByVal strQuery As String, _
    ByRef ResultsArray As Byte()) As Integer
' Send the query.
VisaSendCommandOrQuery(strQuery)

' Get the result string.
Dim length As Integer
' Number of bytes returned from instrument.
length = VisaGetResultIEEEBlock(ResultsArray)

' Check for instrument errors (another command and result).
CheckForInstrumentErrors(strQuery)

' Return string results.
Return length
End Function

Private Sub CheckForInstrumentErrors(ByVal strCommand As String)
' Check for instrument errors.
Dim strInstrumentError As New StringBuilder(1000)
Dim bFirstError As Boolean = True
Do
    VisaSendCommandOrQuery(":SYSTem:ERRor?")
    strInstrumentError = VisaGetResultString()

    If strInstrumentError.ToString() <> _
        "+0,""No error"" & Chr(10) & "" Then
        If bFirstError Then
            Console.WriteLine("ERROR(s) for command '{0}': ", _
                strCommand)
            bFirstError = False
        End If
    End If
End Sub

```

```

        Console.Write(strInstrumentError)
    End If
    Loop While strInstrumentError.ToString() <> _
        "+0,""No error"" & Chr(10) & ""
End Sub

Private Sub VisaSendCommandOrQuery(ByVal strCommandOrQuery _
    As String)
    ' Send command or query to the device.
    Dim strWithNewline As String
    strWithNewline = [String].Format("{0}" & Chr(10) & "", _
        strCommandOrQuery)
    Dim nViStatus As Integer
    nViStatus = visa32.viPrintf(m_nSession, strWithNewline)
    CheckVisaStatus(nViStatus)
End Sub

Private Function VisaGetResultString() As StringBuilder
    Dim strResults As New StringBuilder(1000)

    ' Read return value string from the device.
    Dim nViStatus As Integer
    nViStatus = visa32.viScanf(m_nSession, "%1000t", strResults)
    CheckVisaStatus(nViStatus)

    Return strResults
End Function

Private Function VisaGetResultValue() As Double
    Dim fResults As Double = 0

    ' Read return value string from the device.
    Dim nViStatus As Integer
    nViStatus = visa32.viScanf(m_nSession, "%lf", fResults)
    CheckVisaStatus(nViStatus)

    Return fResults
End Function

Private Function VisaGetResultValues() As Double()
    Dim fResultsArray As Double()
    fResultsArray = New Double(9) {}

    ' Read return value string from the device.
    Dim nViStatus As Integer
    nViStatus = visa32.viScanf(m_nSession, _
        "%,10lf" & Chr(10) & "", fResultsArray)
    CheckVisaStatus(nViStatus)

    Return fResultsArray
End Function

Private Function VisaGetResultIEEEBlock(ByRef ResultsArray _
    As Byte()) As Integer
    ' Results array, big enough to hold a PNG.
    ResultsArray = New Byte(299999) {}
    Dim length As Integer

```



```

' Number of bytes returned from instrument.
' Set the default number of bytes that will be contained in
' the ResultsArray to 300,000 (300kB).
length = 300000

' Read return value string from the device.
Dim nViStatus As Integer
nViStatus = visa32.viScanf(m_nSession, "%#b", length, _
    ResultsArray)
CheckVisaStatus(nViStatus)

' Write and read buffers need to be flushed after IEEE block?
nViStatus = visa32.viFlush(m_nSession, visa32.VI_WRITE_BUF)
CheckVisaStatus(nViStatus)
nViStatus = visa32.viFlush(m_nSession, visa32.VI_READ_BUF)
CheckVisaStatus(nViStatus)

Return length
End Function

Private Sub OpenResourceManager()
Dim nViStatus As Integer
nViStatus = visa32.viOpenDefaultRM(Me.m_nResourceManager)
If nViStatus < visa32.VI_SUCCESS Then
    Throw New _
        ApplicationException("Failed to open Resource Manager")
End If
End Sub

Private Sub OpenSession()
Dim nViStatus As Integer
nViStatus = visa32.viOpen(Me.m_nResourceManager, _
    Me.m_strVisaAddress, visa32.VI_NO_LOCK, _
    visa32.VI_TMO_IMMEDIATE, Me.m_nSession)
CheckVisaStatus(nViStatus)
End Sub

Public Sub SetTimeoutSeconds(ByVal nSeconds As Integer)
Dim nViStatus As Integer
nViStatus = visa32.viSetAttribute(Me.m_nSession, _
    visa32.VI_ATTR_TMO_VALUE, nSeconds * 1000)
CheckVisaStatus(nViStatus)
End Sub

Public Sub CheckVisaStatus(ByVal nViStatus As Integer)
' If VISA error, throw exception.
If nViStatus < visa32.VI_SUCCESS Then
    Dim strError As New StringBuilder(256)
    visa32.viStatusDesc(Me.m_nResourceManager, nViStatus, strError)
    Throw New ApplicationException(strError.ToString())
End If
End Sub

Public Sub Close()
If m_nSession <> 0 Then
    visa32.viClose(m_nSession)
End If

```

12 Programming Examples

```
    If m_nResourceManager <> 0 Then
        visa32.viClose(m_nResourceManager)
    End If
End Sub
End Class
End Namespace
```

SICL Examples

- "SICL Example in C" on page 891
- "SICL Example in Visual Basic" on page 900

SICL Example in C

To compile and run this example in Microsoft Visual Studio 2005:

- 1 Open Visual Studio.
- 2 Create a new Visual C++, Win32, Win32 Console Application project.
- 3 In the Win32 Application Wizard, click **Next >**. Then, check **Empty project**, and click **Finish**.
- 4 Cut-and-paste the code that follows into a file named "example.c" in the project directory.
- 5 In Visual Studio 2005, right-click the Source Files folder, choose **Add > Add Existing Item...**, select the example.c file, and click **Add**.
- 6 Edit the program to use the SICL address of your oscilloscope.
- 7 Choose **Project > Properties...** In the Property Pages dialog, update these project settings:
 - a Under Configuration Properties, Linker, Input, add "sicl32.lib" to the Additional Dependencies field.
 - b Under Configuration Properties, C/C++, Code Generation, select Multi-threaded DLL for the Runtime Library field.
 - c Click **OK** to close the Property Pages dialog.
- 8 Add the include files and library files search paths:
 - a Choose **Tools > Options...**
 - b In the Options dialog, select **VC++ Directories** under Projects and Solutions.
 - c Show directories for **Include files**, and add the include directory (for example, Program Files\Agilent\ IO Libraries Suite\include).
 - d Show directories for **Library files**, and add the library files directory (for example, Program Files\Agilent\IO Libraries Suite\lib).
 - e Click **OK** to close the Options dialog.
- 9 Build and run the program.

```

/*
 * Agilent SICL Example in C
 * -----
 * This program illustrates most of the commonly-used programming
 * features of your Agilent oscilloscope.
 * This program is to be built as a WIN32 console application.

```

12 Programming Examples

```
* Edit the DEVICE_ADDRESS line to specify the address of the
* applicable device.
*/

#include <stdio.h>          /* For printf(). */
#include "sicl.h"          /* SICL routines. */

/* #define DEVICE_ADDRESS "gpib0,7" */          /* GPIB */
/* #define DEVICE_ADDRESS "lan[a-mso6102-90541]:inst0" */ /* LAN */
#define DEVICE_ADDRESS "usb0[2391::5970::30D3090541::0]" /* USB */

#define WAVE_DATA_SIZE 5000
#define TIMEOUT 5000
#define SETUP_STR_SIZE 3000
#define IMG_SIZE 300000

/* Function prototypes */
void initialize(void); /* Initialize the oscilloscope. */
void extra(void); /* Miscellaneous commands not executed,
                  shown for reference purposes. */
void capture(void); /* Digitize data from oscilloscope. */
void analyze(void); /* Make some measurements. */
void get_waveform(void); /* Download waveform data from
                        oscilloscope. */
void save_waveform(void); /* Save waveform data to a file. */
void retrieve_waveform(void); /* Load waveform data from a file. */

/* Global variables */
INST id; /* Device session ID. */
char buf[256] = { 0 }; /* Buffer for IDN string. */

/* Array for waveform data. */
unsigned char waveform_data[WAVE_DATA_SIZE];
double preamble[10]; /* Array for preamble. */

void main(void)
{
    /* Install a default SICL error handler that logs an error message
    * and exits. On Windows 98SE or Windows Me, view messages with
    * the SICL Message Viewer. For Windows 2000 or XP, use the Event
    * Viewer.
    */
    ionerror(I_ERROR_EXIT);

    /* Open a device session using the DEVICE_ADDRESS */
    id = iopen(DEVICE_ADDRESS);

    if (id == 0)
    {
        printf ("Oscilloscope iopen failed!\n");
    }
    else
    {
        printf ("Oscilloscope session initialized!\n");

        /* Set the I/O timeout value for this session to 5 seconds. */
        itimeout(id, TIMEOUT);
    }
}
```

```

        /* Clear the interface. */
        iclear(id);
        iremote(id);
    }

    initialize();

    /* The extras function contains miscellaneous commands that do not
    * need to be executed for the proper operation of this example.
    * The commands in the extras function are shown for reference
    * purposes only.
    */
    /* extra(); */ /* <-- Uncomment to execute the extra function */

    capture();

    analyze();

    /* Close the device session to the instrument. */
    iclose(id);
    printf ("Program execution is complete...\n");

    /* For WIN16 programs, call _siclcleanup before exiting to release
    * resources allocated by SICL for this application. This call is
    * a no-op for WIN32 programs.
    */
    _siclcleanup();
}

/*
 * initialize
 * -----
 * This function initializes both the interface and the oscilloscope
 * to a known state.
 */

void initialize (void)
{
    /* RESET - This command puts the oscilloscope in a known state.
    * Without this command, the oscilloscope settings are unknown.
    * This command is very important for program control.
    *
    * Many of the following initialization commands are initialized
    * by this command. It is not necessary to reinitialize them
    * unless you want to change the default setting.
    */
    fprintf(id, "RST\n");

    /* Write the *IDN? string and send an EOI indicator, then read
    * the response into buf.
    */
    ipromptf(id, "*IDN?\n", "%t", buf);
    printf("%s\n", buf);

    /* AUTOSCALE - This command evaluates all the input signals and
    * sets the correct conditions to display all of the active signals.
    */

```

12 Programming Examples

```
    */
    fprintf(id, ":AUTOSCALE\n");

    /* CHANNEL_PROBE - Sets the probe attenuation factor for the
     * selected channel. The probe attenuation factor may be from
     * 0.1 to 1000.
     */
    fprintf(id, ":CHAN1:PROBE 10\n");

    /* CHANNEL_RANGE - Sets the full scale vertical range in volts.
     * The range value is eight times the volts per division.
     */
    fprintf(id, ":CHANNEL1:RANGE 8\n");

    /* TIME_RANGE - Sets the full scale horizontal time in seconds.
     * The range value is ten times the time per division.
     */
    fprintf(id, ":TIM:RANG 2e-3\n");

    /* TIME_REFERENCE - Possible values are LEFT and CENTER:
     * - LEFT sets the display reference one time division from the
     * left.
     * - CENTER sets the display reference to the center of the screen.
     */
    fprintf(id, ":TIMEBASE:REFERENCE CENTER\n");

    /* TRIGGER_SOURCE - Selects the channel that actually produces the
     * TV trigger. Any channel can be selected.
     */
    fprintf(id, ":TRIGGER:TV:SOURCE CHANNEL1\n");

    /* TRIGGER_MODE - Set the trigger mode to, EDGE, GLITCh, PATtern,
     * CAN, DURation, IIC, LIN, SEQuence, SPI, TV, or USB.
     */
    fprintf(id, ":TRIGGER:MODE EDGE\n");

    /* TRIGGER_EDGE_SLOPE - Set the slope of the edge for the trigger
     * to either POSITIVE or NEGATIVE.
     */
    fprintf(id, ":TRIGGER:EDGE:SLOPE POSITIVE\n");
}

/*
 * extra
 * -----
 * The commands in this function are not executed and are shown for
 * reference purposes only. To execute these commands, call this
 * function from main.
 */

void extra (void)
{
    /* RUN_STOP (not executed in this example):
     * - RUN starts the acquisition of data for the active waveform
     * display.
     * - STOP stops the data acquisition and turns off AUTOSTORE.
     */
}
```

```

iprintf(id, ":RUN\n");
iprintf(id, ":STOP\n");

/* VIEW_BLANK (not executed in this example):
 * - VIEW turns on (starts displaying) an active channel or pixel
 *   memory.
 * - BLANK turns off (stops displaying) a specified channel or
 *   pixel memory.
 */
iprintf(id, ":BLANK CHANNEL1\n");
iprintf(id, ":VIEW CHANNEL1\n");

/* TIME_MODE (not executed in this example) - Set the time base
 * mode to MAIN, DELAYED, XY or ROLL.
 */
iprintf(id, ":TIMEBASE:MODE MAIN\n");
}

/*
 * capture
 * -----
 * This function prepares the scope for data acquisition and then
 * uses the DIGITIZE MACRO to capture some data.
 */

void capture (void)
{
    /* ACQUIRE_TYPE - Sets the acquisition mode. There are three
     * acquisition types NORMAL, PEAK, or AVERAGE.
     */
    iprintf(id, ":ACQUIRE:TYPE NORMAL\n");

    /* ACQUIRE_COMPLETE - Specifies the minimum completion criteria
     * for an acquisition. The parameter determines the percentage
     * of time buckets needed to be "full" before an acquisition is
     * considered to be complete.
     */
    iprintf(id, ":ACQUIRE:COMPLETE 100\n");

    /* DIGITIZE - Used to acquire the waveform data for transfer over
     * the interface. Sending this command causes an acquisition to
     * take place with the resulting data being placed in the buffer.
     */

    /* NOTE! The use of the DIGITIZE command is highly recommended
     * as it will ensure that sufficient data is available for
     * measurement. Keep in mind when the oscilloscope is running,
     * communication with the computer interrupts data acquisition.
     * Setting up the oscilloscope over the bus causes the data
     * buffers to be cleared and internal hardware to be reconfigured.
     * If a measurement is immediately requested there may not have
     * been enough time for the data acquisition process to collect
     * data and the results may not be accurate. An error value of
     * 9.9E+37 may be returned over the bus in this situation.
     */
    iprintf(id, ":DIGITIZE CHAN1\n");
}

```

```

/*
 * analyze
 * -----
 * In this example we will do the following:
 * - Save the system setup to a file for restoration at a later time.
 * - Save the oscilloscope display to a file which can be printed.
 * - Make single channel measurements.
 */

void analyze (void)
{
    double frequency, vpp;          /* Measurements. */
    double vdiv, off, sdiv, delay;  /* Calculated from preamble data. */
    int i;                          /* Loop counter. */
    /* Array for setup string. */
    unsigned char setup_string[SETUP_STR_SIZE];
    int setup_size;
    FILE *fp;
    unsigned char image_data[IMG_SIZE]; /* Array for image data. */
    int img_size;

    /* SAVE_SYSTEM_SETUP - The :SYSTEM:SETUP? query returns a program
     * message that contains the current state of the instrument. Its
     * format is a definite-length binary block, for example,
     * #800002204<setup string><NL>
     * where the setup string is 2204 bytes in length.
     */
    setup_size = SETUP_STR_SIZE;
    /* Query and read setup string. */
    ipromptf(id, ":SYSTEM:SETUP?\n", "%#b\n", &setup_size, setup_string);
    printf("Read setup string query (%d bytes).\n", setup_size);
    /* Write setup string to file. */
    fp = fopen ("c:\\scope\\config\\setup.dat", "wb");
    setup_size = fwrite(setup_string, sizeof(unsigned char), setup_size,
        fp);
    fclose (fp);
    printf("Wrote setup string (%d bytes) to file.\n", setup_size);

    /* RESTORE_SYSTEM_SETUP - Uploads a previously saved setup string
     * to the oscilloscope.
     */
    /* Read setup string from file. */
    fp = fopen ("c:\\scope\\config\\setup.dat", "rb");
    setup_size = fread (setup_string, sizeof(unsigned char),
        SETUP_STR_SIZE, fp);
    fclose (fp);
    printf("Read setup string (%d bytes) from file.\n", setup_size);
    /* Restore setup string. */
    iprintf(id, ":SYSTEM:SETUP #8%08d", setup_size);
    ifwrite(id, setup_string, setup_size, 1, &setup_size);
    printf("Restored setup string (%d bytes).\n", setup_size);

    /* IMAGE_TRANSFER - In this example we will query for the image
     * data with ":DISPLAY:DATA?" to read the data and save the data
     * to the file "image.dat" which you can then send to a printer.
     */
}

```



```

ittimeout(id, 30000);
printf("Transferring image to c:\\scope\\data\\screen.bmp\\n");
img_size = IMG_SIZE;
ipromptf(id, ":DISPLAY:DATA? BMP8bit, SCREEN, COLOR\\n", "%#b\\n",
    &img_size, image_data);
printf("Read display data query (%d bytes).\\n", img_size);
/* Write image data to file. */
fp = fopen ("c:\\scope\\data\\screen.bmp", "wb");
img_size = fwrite(image_data, sizeof(unsigned char), img_size, fp);
fclose (fp);
printf("Wrote image data (%d bytes) to file.\\n", img_size);
ittimeout(id, 5000);

/* MEASURE - The commands in the MEASURE subsystem are used to
 * make measurements on displayed waveforms.
 */

/* Set source to measure. */
iprintf(id, ":MEASURE:SOURCE CHANNEL1\\n");

/* Query for frequency. */
ipromptf(id, ":MEASURE:FREQUENCY?\\n", "%lf", &frequency);
printf("The frequency is: %.4f kHz\\n", frequency / 1000);

/* Query for peak to peak voltage. */
ipromptf(id, ":MEASURE:VPP?\\n", "%lf", &vpp);
printf("The peak to peak voltage is: %.2f V\\n", vpp);

/* WAVEFORM_DATA - Get waveform data from oscilloscope.
 */
get_waveform();

/* Make some calculations from the preamble data. */
vdiv = 32 * preamble [7];
off = preamble [8];
sdiv = preamble [2] * preamble [4] / 10;
delay = (preamble [2] / 2) * preamble [4] + preamble [5];

/* Print them out... */
printf ("Scope Settings for Channel 1:\\n");
printf ("Volts per Division = %f\\n", vdiv);
printf ("Offset = %f\\n", off);
printf ("Seconds per Division = %f\\n", sdiv);
printf ("Delay = %f\\n", delay);

/* print out the waveform voltage at selected points */
for (i = 0; i < 1000; i = i + 50)
    printf ("Data Point %4d = %6.2f Volts at %10f Seconds\\n", i,
        ((float)waveform_data[i] - preamble[9]) * preamble[7] +
        preamble[8],
        ((float)i - preamble[6]) * preamble[4] + preamble[5]);

save_waveform();          /* Save waveform data to disk. */
retrieve_waveform();     /* Load waveform data from disk. */
}

/*

```

12 Programming Examples

```
* get_waveform
* -----
* This function transfers the data displayed on the oscilloscope to
* the computer for storage, plotting, or further analysis.
*/

void get_waveform (void)
{
    int waveform_size;

    /* WAVEFORM_DATA - To obtain waveform data, you must specify the
    * WAVEFORM parameters for the waveform data prior to sending the
    * ":WAVEFORM:DATA?" query.
    *
    * Once these parameters have been sent, the ":WAVEFORM:PREAMBLE?"
    * query provides information concerning the vertical and horizontal
    * scaling of the waveform data.
    *
    * With the preamble information you can then use the
    * ":WAVEFORM:DATA?" query and read the data block in the
    * correct format.
    */

    /* WAVE_FORMAT - Sets the data transmission mode for waveform data
    * output. This command controls how the data is formatted when
    * sent from the oscilloscope and can be set to WORD or BYTE format.
    */

    /* Set waveform format to BYTE. */
    fprintf(id, ":WAVEFORM:FORMAT BYTE\n");

    /* WAVE_POINTS - Sets the number of points to be transferred.
    * The number of time points available is returned by the
    * "ACQUIRE:POINTS?" query. This can be set to any binary
    * fraction of the total time points available.
    */
    fprintf(id, ":WAVEFORM:POINTS 1000\n");

    /* GET_PREAMBLE - The preamble contains all of the current WAVEFORM
    * settings returned in the form <preamble block><NL> where the
    * <preamble block> is:
    *   FORMAT      : int16 - 0 = BYTE, 1 = WORD, 4 = ASCII.
    *   TYPE        : int16 - 0 = NORMAL, 1 = PEAK DETECT, 2 = AVERAGE.
    *   POINTS      : int32 - number of data points transferred.
    *   COUNT       : int32 - 1 and is always 1.
    *   XINCREMENT  : float64 - time difference between data points.
    *   XORIGIN     : float64 - always the first data point in memory.
    *   XREFERENCE  : int32 - specifies the data point associated
    *                       with the x-origin.
    *   YINCREMENT  : float32 - voltage difference between data points.
    *   YORIGIN     : float32 - value of the voltage at center screen.
    *   YREFERENCE  : int32 - data point where y-origin occurs.
    */
    printf("Reading preamble\n");
    ipromptf(id, ":WAVEFORM:PREAMBLE?\n", "%,10lf\n", preamble);
    /*
    printf("Preamble FORMAT: %e\n", preamble[0]);
    */
}
```

```

printf("Preamble TYPE: %e\n", preamble[1]);
printf("Preamble POINTS: %e\n", preamble[2]);
printf("Preamble COUNT: %e\n", preamble[3]);
printf("Preamble XINCREMENT: %e\n", preamble[4]);
printf("Preamble XORIGIN: %e\n", preamble[5]);
printf("Preamble XREFERENCE: %e\n", preamble[6]);
printf("Preamble YINCREMENT: %e\n", preamble[7]);
printf("Preamble YORIGIN: %e\n", preamble[8]);
printf("Preamble YREFERENCE: %e\n", preamble[9]);
*/

/* QUERY_WAVE_DATA - Outputs waveform records to the controller
 * over the interface that is stored in a buffer previously
 * specified with the ":WAVEFORM:SOURCE" command.
 */
iprintf(id, ":WAVEFORM:DATA?\n"); /* Query waveform data. */

/* READ_WAVE_DATA - The wave data consists of two parts: the header,
 * and the actual waveform data followed by an New Line (NL)
 * character. The query data has the following format:
 *
 * <header><waveform data block><NL>
 *
 * Where:
 *
 * <header> = #800002048 (this is an example header)
 *
 * The "#8" may be stripped off of the header and the remaining
 * numbers are the size, in bytes, of the waveform data block.
 * The size can vary depending on the number of points acquired
 * for the waveform which can be set using the ":WAVEFORM:POINTS"
 * command. You may then read that number of bytes from the
 * oscilloscope; then, read the following NL character to
 * terminate the query.
 */
waveform_size = WAVE_DATA_SIZE;
/* Read waveform data. */
iscanf(id, "%#b\n", &waveform_size, waveform_data);
if ( waveform_size == WAVE_DATA_SIZE )
{
    printf("Waveform data buffer full: ");
    printf("May not have received all points.\n");
}
else
{
    printf("Reading waveform data... size = %d\n", waveform_size);
}
}

/*
 * save_waveform
 * -----
 * This function saves the waveform data from the get_waveform
 * function to disk. The data is saved to a file called "wave.dat".
 */

void save_waveform(void)

```

```
{
    FILE *fp;

    fp = fopen("c:\\scope\\data\\wave.dat", "wb");
    /* Write preamble. */
    fwrite(preamble, sizeof(preamble[0]), 10, fp);
    /* Write actually waveform data. */
    fwrite(waveform_data, sizeof(waveform_data[0]),
           (int)preamble[2], fp);
    fclose (fp);
}

/*
 * retrieve_waveform
 * -----
 * This function retrieves previously saved waveform data from a
 * file called "wave.dat".
 */

void retrieve_waveform(void)
{
    FILE *fp;

    fp = fopen("c:\\scope\\data\\wave.dat", "rb");
    /* Read preamble. */
    fread (preamble, sizeof(preamble[0]), 10, fp);
    /* Read the waveform data. */
    fread (waveform_data, sizeof(waveform_data[0]),
           (int)preamble[2], fp);
    fclose (fp);
}
```

SICL Example in Visual Basic

To run this example in Visual Basic for Applications:

- 1 Start the application that provides Visual Basic for Applications (for example, Microsoft Excel).
- 2 Press ALT+F11 to launch the Visual Basic editor.
- 3 Add the sicl32.bas file to your project:
 - a Choose **File>Import File....**
 - b Navigate to the header file, sicl32.bas (installed with Agilent IO Libraries Suite and found in the Program Files\Agilent\IO Libraries Suite\include directory), select it, and click **Open**.
- 4 Choose **Insert>Module**.
- 5 Cut-and-paste the code that follows into the editor.
- 6 Edit the program to use the SICL address of your oscilloscope, and save the changes.
- 7 Run the program.

```

'
' Agilent SICL Example in Visual Basic
' -----
' This program illustrates a few commonly-used programming
' features of your Agilent oscilloscope.
' -----

Option Explicit

Public id As Integer ' Session to instrument.

' Declare variables to hold numeric values returned by
' ivscanf/ifread.
Public dblQueryResult As Double
Public Const ByteArraySize = 5000000
Public retCount As Long
Public byteArray(ByteArraySize) As Byte

' Declare fixed length string variable to hold string value returned
' by ivscanf.
Public strQueryResult As String * 200

'
' Main Program
' -----

Sub Main()

    On Error GoTo ErrorHandler

    ' Open a device session using the SICL_ADDRESS.
    id = iopen("lan[130.29.69.12]:inst0")
    Call itimeout(id, 5000)

    ' Initialize - start from a known state.
    Initialize

    ' Capture data.
    Capture

    ' Analyze the captured waveform.
    Analyze

    ' Close the vi session and the resource manager session.
    Call iclose(id)

    Exit Sub

ErrorHandler:

    MsgBox "*** Error : " + Error, vbExclamation
    End

End Sub

'
' Initialize the oscilloscope to a known state.

```

12 Programming Examples

```
' -----  
  
Private Sub Initialize()  
  
    On Error GoTo ErrorHandler  
  
    ' Clear the interface.  
    Call iclear(id)  
  
    ' Get and display the device's *IDN? string.  
    strQueryResult = DoQueryString("*IDN?")  
    MsgBox "Result is: " + RTrim(strQueryResult), vbOKOnly, "*IDN? Result"  
  
    ' Clear status and load the default setup.  
    DoCommand "*CLS"  
    DoCommand "*RST"  
  
    Exit Sub  
  
ErrorHandler:  
  
    MsgBox "*** Error : " + Error, vbExclamation  
    End  
  
End Sub  
  
'  
' Capture the waveform.  
' -----  
  
Private Sub Capture()  
  
    On Error GoTo ErrorHandler  
  
    ' Use auto-scale to automatically configure oscilloscope.  
    ' -----  
    DoCommand ":AUToscale"  
  
    ' Save oscilloscope configuration.  
    ' -----  
    Dim lngSetupStringSize As Long  
    lngSetupStringSize = DoQueryIEEEBlock_Bytes(":SYSTem:SETup?")  
    Debug.Print "Setup bytes saved: " + CStr(lngSetupStringSize)  
  
    ' Output setup string to a file:  
    Dim strPath As String  
    strPath = "c:\scope\config\setup.dat"  
  
    ' Open file for output.  
    Dim hFile As Long  
    hFile = FreeFile  
    Open strPath For Binary Access Write Lock Write As hFile  
    Dim lngI As Long  
    For lngI = 0 To lngSetupStringSize - 1  
        Put hFile, , byteArray(lngI) ' Write data.  
    Next lngI  
    Close hFile ' Close file.
```

```

' Or, configure the settings with individual commands:
' -----

' Set trigger mode and input source.
DoCommand ":TRIGger:MODE EDGE"
Debug.Print "Trigger mode: " + _
    DoQueryString(":TRIGger:MODE?")

' Set EDGE trigger parameters.
DoCommand ":TRIGger:EDGE:SOURCe CHANnel1"
Debug.Print "Trigger edge source: " + _
    DoQueryString(":TRIGger:EDGE:SOURce?")

DoCommand ":TRIGger:EDGE:LEVel 1.5"
Debug.Print "Trigger edge level: " + _
    DoQueryString(":TRIGger:EDGE:LEVel?")

DoCommand ":TRIGger:EDGE:SLOPe POSitive"
Debug.Print "Trigger edge slope: " + _
    DoQueryString(":TRIGger:EDGE:SLOPe?")

' Set vertical scale and offset.
DoCommand ":CHANnel1:SCALe 0.5"
Debug.Print "Channel 1 vertical scale: " + _
    DoQueryString(":CHANnel1:SCALe?")

DoCommand ":CHANnel1:OFFSet 1.5"
Debug.Print "Channel 1 vertical offset: " + _
    DoQueryString(":CHANnel1:OFFSet?")

' Set horizontal scale and offset.
DoCommand ":TIMEbase:SCALe 0.0002"
Debug.Print "Timebase scale: " + _
    DoQueryString(":TIMEbase:SCALe?")

DoCommand ":TIMEbase:POSition 0.0"
Debug.Print "Timebase position: " + _
    DoQueryString(":TIMEbase:POSition?")

' Set the acquisition type (NORMAL, PEAK, AVERage, or HRESolution).
DoCommand ":ACQuire:TYPE NORMAL"
Debug.Print "Acquire type: " + _
    DoQueryString(":ACQuire:TYPE?")

' Or, configure by loading a previously saved setup.
' -----
strPath = "c:\scope\config\setup.dat"
Open strPath For Binary Access Read As hFile ' Open file for input.
Dim lngSetupFileSize As Long
lngSetupFileSize = LOF(hFile) ' Length of file.
Get hFile, , byteArray ' Read data.
Close hFile ' Close file.
' Write learn string back to oscilloscope using ":SYSTem:SETup"
' command:
Dim lngRestored As Long
lngRestored = DoCommandIEEEBlock(":SYSTem:SETup", lngSetupFileSize)

```

12 Programming Examples

```
Debug.Print "Setup bytes restored: " + CStr(lngRestored)

' Acquire data.
' -----
DoCommand ":DIGitize"

Exit Sub

ErrorHandler:

MsgBox "*** Error : " + Error, vbExclamation
End

End Sub

'
' Analyze the captured waveform.
' -----

Private Sub Analyze()

On Error GoTo ErrorHandler

' Make a couple of measurements.
' -----
DoCommand ":MEASure:SOURce CHANnel1"
Debug.Print "Measure source: " + _
    DoQueryString(":MEASure:SOURce?")

DoCommand ":MEASure:VAMPlitude"
dblQueryResult = DoQueryNumber(":MEASure:VAMPlitude?")
MsgBox "Vertical amplitude:" + vbCrLf + _
    FormatNumber(dblQueryResult, 4) + " V"

DoCommand ":MEASure:FREQuency"
dblQueryResult = DoQueryNumber(":MEASure:FREQuency?")
MsgBox "Frequency:" + vbCrLf + _
    FormatNumber(dblQueryResult / 1000, 4) + " kHz"

' Download the screen image.
' -----
' Get screen image.
Dim lngBlockSize As Long
lngBlockSize = _
    DoQueryIEEEBlock_Bytes(":DISPlay:DATA? PNG, SCReen, COLOr")
Debug.Print "Image IEEEBlock bytes: " + CStr(lngBlockSize)

' Save screen image to a file:
Dim strPath As String
strPath = "c:\scope\data\screen.png"
Dim hFile As Long
hFile = FreeFile
Open strPath For Binary Access Write Lock Write As hFile
Dim lngI As Long
For lngI = 10 To lngBlockSize - 1 ' Skip past 10-byte header.
    Put hFile, , byteArray(lngI) ' Write data.
Next lngI
```



```

Close hFile ' Close file.
MsgBox "Screen image written to " + strPath

' Download waveform data.
' -----
Dim lngPoints As Long
Dim dblXIncrement As Double
Dim dblXOrigin As Double
Dim dblYIncrement As Double
Dim dblYOrigin As Double
Dim dblYReference As Double

' Set the waveform source.
DoCommand ":WAVEform:SOURce CHANnel1"
Debug.Print "Waveform source: " + _
    DoQueryString(":WAVEform:SOURce?")

' Get the number of waveform points:
' How do you get max depth like when saving CSV from front panel?
dblQueryResult = DoQueryNumber(":WAVEform:POINTs?")
lngPoints = dblQueryResult
Debug.Print "Waveform points, channel 1: " + _
    CStr(lngPoints)

' Display the waveform settings:
dblXIncrement = DoQueryNumber(":WAVEform:XINCrement?")
Debug.Print "Waveform X increment, channel 1: " + _
    Format(dblXIncrement, "Scientific")
dblXOrigin = DoQueryNumber(":WAVEform:XORigin?")
Debug.Print "Waveform X origin, channel 1: " + _
    Format(dblXOrigin, "Scientific")

dblYIncrement = DoQueryNumber(":WAVEform:YINCrement?")
Debug.Print "Waveform Y increment, channel 1: " + _
    Format(dblYIncrement, "Scientific")
dblYOrigin = DoQueryNumber(":WAVEform:YORigin?")
Debug.Print "Waveform Y origin, channel 1: " + _
    Format(dblYOrigin, "Scientific")
dblYReference = DoQueryNumber(":WAVEform:YREFerence?")
Debug.Print "Waveform Y reference, channel 1: " + _
    Format(dblYReference, "Scientific")

' Choose the format of the data returned (WORD, BYTE, ASCII):
DoCommand ":WAVEform:FORMat BYTE"
Debug.Print "Waveform format: " + _
    DoQueryString(":WAVEform:FORMat?")
' Data in range 0 to 255.
Dim lngVSteps As Long
Dim intBytesPerData As Integer
lngVSteps = 256
intBytesPerData = 1

' Get the waveform data
Dim lngNumBytes As Long
lngNumBytes = DoQueryIEEEBlock_Bytes(":WAVEform:DATA?")
Debug.Print "Waveform data IEEEBlock bytes: " + CStr(lngNumBytes)

```

12 Programming Examples

```
' Set up output file:
strPath = "c:\scope\data\waveform_data.csv"

' Open file for output.
Open strPath For Output Access Write Lock Write As hFile

' Output waveform data in CSV format.
Dim lngDataValue As Long

For lngI = 10 To lngNumBytes - 2 ' Skip past 10-byte header.
    lngDataValue = CLng(byteArray(lngI))

    ' Write time value, voltage value.
    Print #hFile, _
        Format(dblXOrigin + lngI * dblXIncrement, "Scientific") + _
        ", " + _
        FormatNumber((lngDataValue - dblyReference) * dblyIncrement + _
            dblyOrigin)

Next lngI

' Close output file.
Close hFile ' Close file.
MsgBox "Waveform format BYTE data written to " + _
    "c:\scope\data\waveform_data.csv."

Exit Sub

ErrorHandler:

    MsgBox "*** Error : " + Error, vbExclamation
End

End Sub

Private Sub DoCommand(command As String)

    On Error GoTo ErrorHandler

    Call ivprintf(id, command + vbLf)
    CheckForInstrumentErrors command

    Exit Sub

ErrorHandler:

    MsgBox "*** Error : " + Error, vbExclamation
End

End Sub

Private Function DoCommandIEEEBlock(command As String, _
    lngBlockSize As Long)

    On Error GoTo ErrorHandler

    ' Send command part.
```

```

Call ivprintf(id, command + " ")
' Write definite-length block bytes.
Call ifwrite(id, byteArray(), lngBlockSize, vbNull, retCount)
' retCount is now actual number of bytes written.
CheckForInstrumentErrors command
DoCommandIEEEBlock = retCount

```

```
Exit Function
```

```
ErrorHandler:
```

```
MsgBox "*** Error : " + Error, vbExclamation
End
```

```
End Function
```

```
Private Function DoQueryString(query As String) As String
```

```
Dim actual As Long
```

```
On Error GoTo ErrorHandler
```

```
Dim ret_val As Integer
```

```
Dim strResult As String * 200
```

```
Call ivprintf(id, query + vbLf)
Call ivscanf(id, "%200t", strResult)
CheckForInstrumentErrors query
DoQueryString = strResult

```

```
Exit Function
```

```
ErrorHandler:
```

```
MsgBox "*** Error : " + Error, vbExclamation
End
```

```
End Function
```

```
Private Function DoQueryNumber(query As String) As Double
```

```
On Error GoTo ErrorHandler
```

```
Dim dblResult As Double
```

```
Call ivprintf(id, query + vbLf)
Call ivscanf(id, "%lf" + vbLf, dblResult)
CheckForInstrumentErrors query
DoQueryNumber = dblResult

```

```
Exit Function
```

```
ErrorHandler:
```

```
MsgBox "*** Error : " + Error, vbExclamation
End
```

12 Programming Examples

```
End Function

Private Function DoQueryIEEEBlock_Bytes(query As String) As Long

    On Error GoTo ErrorHandler

    ' Send query.
    Call ivprintf(id, query + vbCrLf)
    ' Read definite-length block bytes.
    Call ifread(id, byteArray(), ByVal byteArraySize, ByVal retCount)
    ' retCount is now actual number of bytes returned by read.
    CheckForInstrumentErrors query
    DoQueryIEEEBlock_Bytes = retCount

Exit Function

ErrorHandler:

    MsgBox "*** Error : " + Error, vbExclamation
End

End Function

Private Sub CheckForInstrumentErrors(strCmdOrQuery As String)

    On Error GoTo ErrorHandler

    Dim strErrVal As String * 200
    Dim strOut As String

    Do
        Call ivprintf(id, "SYSTEM:ERROR?" + vbCrLf) ' Request error message.
        Call ivscanf(id, "%200t", strErrVal) ' Read: Errno,"Error String".
        If Val(strErrVal) <> 0 Then
            strOut = strOut + "INST Error: " + RTrim(strErrVal) + vbCrLf
        End If
    Loop While Val(strErrVal) <> 0 ' End if find: 0,"No Error".

    If Not strOut = "" Then
        MsgBox strOut, vbExclamation, "INST Error Messages, " + _
            strCmdOrQuery
        Call iflush(id, I_BUF_DISCARD_READ Or I_BUF_DISCARD_WRITE)
    End If

Exit Sub

ErrorHandler:

    MsgBox "*** Error: " + Error, vbExclamation

End Sub
```

Index

Symbols

+9.9E+37, infinity representation, [808](#)
+9.9E+37, measurement error, [312](#)

Numerics

0 (zero) values in waveform data, [626](#)
1 (one) values in waveform data, [626](#)
10 MHz REF BNC, enabling/disabling, [460](#)
10 MHz reference signal, [189](#)
82350A GPIB interface, [4](#)

A

AC coupling, trigger edge, [500](#)
AC input coupling for specified channel, [221](#)
accumulate activity, [142](#)
acknowledge, [738](#)
ACQuire commands, [181](#)
acquire data, [150, 196](#)
acquire mode on autoscale, [146](#)
acquire reset conditions, [128](#)
acquire sample rate, [195](#)
ACQuire subsystem, [51](#)
acquired data points, [188](#)
acquisition anti-alias control, [183](#)
acquisition count, [185](#)
acquisition mode, [181, 187, 643](#)
acquisition type, [181, 196](#)
acquisition types, [618](#)
active edges, [142](#)
active printer, [284](#)
activity logic levels, [142](#)
activity on digital channels, [142](#)
add function, [638](#)
add math function, [273](#)
add math function as g(t) source, [269](#)
address field size, IIC serial decode, [433](#)
address, IIC trigger pattern, [545](#)
Addresses softkey, [38](#)
AER (Arm Event Register), [143, 165, 167, 768](#)
Agilent Connection Expert, [39](#)
Agilent Interactive IO application, [43](#)
Agilent IO Control icon, [39](#)
Agilent IO Libraries Suite, [4, 35, 48, 50](#)
Agilent IO Libraries Suite, installing, [36](#)
ALB waveform data format, [417](#)
alignment, I2S trigger, [528](#)
ALL segments waveform save option, [419](#)
alphabetical list of commands, [653](#)
AMASk commands, [654](#)
amplitude, vertical, [346](#)

analog channel coupling, [221](#)
analog channel display, [222](#)
analog channel impedance, [223](#)
analog channel input, [697](#)
analog channel inversion, [224](#)
analog channel labels, [225, 250](#)
analog channel offset, [226](#)
analog channel protection lock, [451](#)
analog channel range, [233](#)
analog channel scale, [234](#)
analog channel source for glitch, [525](#)
analog channel units, [235](#)
analog channels only oscilloscopes, [4](#)
analog probe attenuation, [227](#)
analog probe head type, [228](#)
analog probe sensing, [698](#)
analog probe skew, [230, 696](#)
analyzing captured data, [47](#)
angle brackets, [109](#)
annotate channels, [225](#)
anti-alias control, [183](#)
AREA commands, [654](#)
area for hardcopy print, [283](#)
area for saved image, [407](#)
Arm Event Register (AER), [143, 165, 167, 768](#)
arrange waveforms, [700](#)
ASCII format, [628](#)
ASCII format for data transfer, [622](#)
ASCII string, quoted, [109](#)
ASCIixy waveform data format, [417](#)
assign channel names, [225](#)
attenuation factor (external trigger) probe, [258](#)
attenuation for oscilloscope probe, [227](#)
audio channel, I2S trigger, [529](#)
AUT option for probe sense, [698, 703](#)
auto setup for M1553 trigger, [567](#)
auto trigger sweep mode, [467](#)
automask create, [363](#)
automask source, [364](#)
automask units, [365](#)
automatic measurements constants, [227](#)
automatic probe type detection, [698, 703](#)
Automation-Ready CD, [36](#)
autoscale, [144](#)
autoscale acquire mode, [146](#)
autoscale channels, [147](#)
AUToscale command, [50](#)
AUTosetup commands, [654](#)
autosetup for FLEXray trigger, [506](#)
AVERage commands, [654](#)
average value measurement, [347](#)
averaging acquisition type, [182, 620](#)
averaging, synchronizing with, [782](#)

B

bandwidth filter limits, [256](#)
bandwidth filter limits to 20 MHz, [220](#)
BASE commands, [655](#)
base value measurement, [348](#)
base, I2S serial decode, [432](#)
base, MIL-STD 1553 serial decode, [435](#)
base, UART trigger, [598](#)
basic instrument functions, [116](#)
Bat On bit, [154, 156](#)
baud rate, [485, 561, 599](#)
BAUDrate commands, [655](#)
begin acquisition, [150, 174, 176](#)
BHARris window for minimal spectral leakage, [280](#)
binary block data, [109, 452, 626](#)
BINary waveform data format, [417](#)
bind levels for masks, [385](#)
bit order, [600](#)
bit order, SPI decode, [437](#)
bit selection command, bus, [200](#)
bit weights, [120](#)
bitmap display, [247](#)
BITorder commands, [655](#)
bits in Service Request Enable Register, [133](#)
bits in Standard Event Status Enable Register, [119](#)
bits in Status Byte Register, [135](#)
bits selection command, bus, [201](#)
blank, [148](#)
block data, [109, 123, 247, 452](#)
block response data, [54](#)
blocking synchronization, [777](#)
blocking wait, [776](#)
BMP (bitmap) hardcopy format, [709](#)
braces, [108](#)
built-in measurements, [47](#)
burst, minimum time before next, [497](#)
bus bit selection command, [200](#)
bus bits selection commands, [201](#)
bus clear command, [203](#)
bus commands, [199](#)
BUS data format, [623](#)
bus display, [204](#)
bus label command, [205](#)
bus mask command, [206](#)
BUS<n> commands, [198](#)
button disable, [449](#)
BWLimit commands, [655](#)
byte format for data transfer, [622, 628](#)
BYTeorder, [624](#)

C

- C, SICL library example, 891
- C, VISA library example, 845
- C#, VISA COM example, 822
- C#, VISA example, 864
- CAL PROTECT switch, 207, 214
- calculating preshoot of waveform, 329
- calculating the waveform overshoot, 325
- calibrate, 209, 210, 214, 216
- CALibrate commands, 207
- calibrate date, 209
- calibrate introduction, 207
- calibrate label, 210
- calibrate output, 211
- calibrate start, 212
- calibrate status, 213
- calibrate switch, 214
- calibrate temperature, 215
- calibrate time, 216
- CAN, 480
- CAN acknowledge, 484, 738
- CAN baud rate, 485
- CAN commands, 656
- CAN frame counters, reset, 424
- CAN id pattern, 482
- CAN signal definition, 739
- CAN source, 486
- CAN trigger, 481, 487
- CAN trigger commands, 478
- CAN trigger pattern id mode, 483
- CAN triggering, 468
- capture data, 150
- capturing data, 46
- CDISplay, 149
- center frequency set, 266, 267
- center of screen, 651
- center reference, 461
- center screen, vertical value at, 272, 275
- channel, 180, 225, 693, 695
- channel coupling, 221
- channel display, 222
- channel input impedance, 223
- channel inversion, 224
- channel label, 225, 694
- channel labels, 249, 250
- channel numbers, 700
- channel overload, 232
- channel probe ID, 259
- channel protection, 232
- channel reset conditions, 128
- channel selected to produce trigger, 525, 594
- channel signal type, 231
- channel skew for oscilloscope probe, 230, 696
- channel status, 177, 700
- channel threshold, 695
- channel vernier, 236
- channel, stop displaying, 148
- CHANnel<n> commands, 217, 218
- channels to autoscale, 147
- channels, how autoscale affects, 144
- characters to display, 447
- classes of input signals, 280
- classifications, command, 786
- clear, 246
- clear bus command, 203
- CLEar commands, 657
- clear cumulative edge variables, 693
- clear display, 149
- clear markers, 314, 714
- clear measurement, 314, 714
- clear message queue, 117
- Clear method, 49
- clear screen, 701
- clear status, 117
- clear waveform area, 244
- clipped high waveform data value, 626
- clipped low waveform data value, 626
- clock, 548, 582, 583, 587
- CLOCK commands, 657
- clock slope, I2S, 530
- CLOCK source, I2S, 537
- CLS (Clear Status), 117
- CME (Command Error) status bit, 119, 121
- CMOS threshold voltage for digital channels, 243, 695
- CMOS trigger threshold voltage, 741
- code, :ACQUIRE:COMPLETE, 184
- code, :ACQUIRE:SEGMENTED, 192
- code, :ACQUIRE:TYPE, 197
- code, :AUTOSCALE, 145
- code, :CHANNEL<n>:LABEL, 225
- code, :CHANNEL<n>:PROBE, 227
- code, :CHANNEL<n>:RANGE, 233
- code, :DIGITIZE, 150
- code, :DISPLAY:DATA, 248
- code, :DISPLAY:LABEL, 249
- code, :DISPLAY:ORDER, 700
- code, :MEASURE:PERIOD, 338
- code, :MEASURE:RESULTS, 331
- code, :MEASURE:TEDGE, 343
- code, :MTEST, 360
- code, :POD<n>:THRESHOLD, 395
- code, :RUN/STOP, 174
- code, :SYSTEM:SETUP, 452
- code, :TIMEBASE:DELAY, 737
- code, :TIMEBASE:MODE, 457
- code, :TIMEBASE:RANGE, 459
- code, :TIMEBASE:REFERENCE, 461
- code, :TRIGGER:MODE, 473
- code, :TRIGGER:SLOPE, 503
- code, :TRIGGER:SOURCE, 504
- code, :VIEW and :BLANK, 180
- code, :WAVEFORM, 639
- code, :WAVEFORM:DATA, 626
- code, :WAVEFORM:POINTS, 630
- code, :WAVEFORM:PREAMBLE, 634
- code, :WAVEFORM:SEGMENTED, 192
- code, *RST, 130
- code, SICL library example in C, 891
- code, SICL library example in Visual Basic, 900
- code, VISA COM library example in C#, 822
- code, VISA COM library example in Visual Basic, 812
- code, VISA COM library example in Visual Basic .NET, 834
- code, VISA library example in C, 845
- code, VISA library example in C#, 864
- code, VISA library example in Visual Basic, 854
- code, VISA library example in Visual Basic .NET, 877
- colon, root commands prefixed by, 141
- color palette for hardcopy, 289
- color palette for image, 411
- Comma Separated Values (CSV) hardcopy format, 709
- Comma Separated Values (CSV) waveform data format, 417
- command classifications, 786
- command errors detected in Standard Event Status, 121
- command header, 788
- command headers, common, 790
- command headers, compound, 789
- command headers, simple, 789
- command strings, valid, 787
- command tree, 791
- commands by subsystem, 111
- commands in alphabetical order, 653
- commands quick reference, 59
- commands sent over interface, 116
- commands, more about, 785
- commands, obsolete and discontinued, 687
- common (*) commands, 112, 113, 116
- common command headers, 790
- completion criteria for an acquisition, 184, 185
- compound command headers, 789
- compound header, 806
- computer control examples, 811
- conditions for external trigger, 254
- conditions, reset, 128
- configurations, oscilloscope, 123, 127, 131, 452
- Configure softkey, 38
- connect oscilloscope, 37
- connect sampled data points, 699
- constants for making automatic measurements, 227
- constants for scaling display factors, 227
- constants for setting trigger levels, 227
- Control softkey, 37, 38
- controller initialization, 46
- copy display, 173
- core commands, 786
- count, 574, 625
- COUNT commands, 657
- count values, 185
- count, Nth edge of burst, 496
- counter, 315
- coupling, 500
- COUPLing commands, 658
- coupling for channels, 221
- create automask, 363
- CSV (Comma Separated Values) hardcopy format, 709

CSV (Comma Separated Values) waveform data format, [417](#)
 cumulative edge activity, [693](#)
 current logic levels on digital channels, [142](#)
 current oscilloscope configuration, [123](#), [127](#), [131](#), [452](#)
 current probe, [235](#), [263](#)
 CURRent segment waveform save option, [419](#)
 cursor mode, [297](#)
 cursor position, [298](#), [300](#), [302](#), [303](#), [305](#)
 cursor readout, [715](#), [719](#), [720](#)
 cursor reset conditions, [128](#)
 cursor source, [299](#), [301](#)
 cursor time, [715](#), [719](#), [720](#)
 cursors track measurements, [336](#)
 cursors, how autoscale affects, [144](#)
 cursors, X1, X2, Y1, Y2, [296](#)
 cycle count base, FLEXray frame trigger, [511](#)
 cycle count repetition, FLEXray frame trigger, [512](#)
 cycle measured, [321](#)
 cycle time, [327](#)

D

D- source, [612](#)
 D+ source, [613](#)
 data, [480](#), [546](#), [549](#), [585](#), [588](#), [626](#)
 data 2, [547](#)
 data acquisition types, [618](#)
 DATA commands, [658](#)
 data conversion, [620](#)
 data displayed, [247](#)
 data format for transfer, [621](#)
 data output order, [624](#)
 data pattern length, [481](#), [558](#)
 data pattern width, [586](#)
 data point index, [648](#)
 data points, [188](#)
 data record, deep analysis, [450](#)
 data record, measurement, [450](#), [631](#)
 data record, precision analysis, [631](#)
 data record, raw acquisition, [631](#)
 data required to fill time buckets, [184](#)
 DATA source, I2S, [538](#)
 data structures, status reporting, [754](#)
 data transfer, [247](#)
 data, erasing, [149](#)
 data, saving and recalling, [244](#)
 DATE commands, [658](#)
 date, calibration, [209](#)
 date, system, [446](#)
 dB versus frequency, [266](#)
 DC coupling for edge trigger, [500](#)
 DC input coupling for specified channel, [221](#)
 dc RMS measured on waveform, [353](#)
 DDE (Device Dependent Error) status bit, [119](#), [121](#)
 decision chart, status reporting, [774](#)
 deep analysis record, [450](#)
 default conditions, [128](#)
 define channel labels, [225](#)

define glitch trigger, [523](#)
 define logic thresholds, [695](#)
 define measurement, [317](#)
 define measurement source, [337](#)
 define trigger, [475](#), [490](#), [491](#), [492](#), [494](#), [524](#), [575](#)
 defined as, [108](#)
 definite-length block query response, [54](#)
 definite-length block response data, [109](#)
 DEFinition commands, [658](#)
 DELay commands, [659](#)
 delay measured to calculate phase, [328](#)
 delay measurement, [317](#)
 delay measurements, [342](#)
 delay parameters for measurement, [319](#)
 delay, how autoscale affects, [144](#)
 delayed time base, [457](#)
 delayed time base mode, how autoscale affects, [144](#)
 delayed window horizontal scale, [466](#)
 delete mask, [373](#)
 delta time, [715](#)
 delta voltage measurement, [724](#)
 delta X cursor, [296](#)
 delta Y cursor, [296](#)
 DeskJet, [707](#)
 destination, [252](#)
 detecting probe types, [698](#), [703](#)
 device for hardcopy, [707](#)
 device-defined error queue clear, [117](#)
 differential probe heads, [228](#)
 differential signal type, [231](#), [260](#)
 differentiate math function, [186](#), [266](#), [273](#), [638](#)
 DIFFerentiate source for function, [278](#), [704](#)
 digital channel commands, [237](#), [239](#), [240](#), [241](#), [243](#)
 digital channel data, [623](#)
 digital channel labels, [250](#)
 digital channel order, [700](#)
 digital channel source for glitch trigger, [525](#)
 digital channels, [4](#)
 digital channels, activity and logic levels on, [142](#)
 digital channels, groups of, [392](#), [393](#), [395](#)
 digital pod, stop displaying, [148](#)
 digital reset conditions, [128](#)
 DIGital<n> commands, [237](#)
 digitize channels, [150](#)
 DIGitize command, [47](#), [51](#), [619](#)
 digits, [109](#)
 disable anti-alias mode, [186](#)
 disable front panel, [449](#)
 disable function, [705](#)
 disabling calibration, [214](#)
 disabling channel display, [222](#)
 disabling status register bits, [118](#), [132](#)
 discontinued and obsolete commands, [687](#)
 display channel labels, [249](#)
 display clear, [246](#)
 DISPLAY commands, [244](#), [659](#)
 display commands introduction, [244](#)
 display connect, [699](#)

display data, [247](#)
 display date, [446](#)
 display factors scaling, [227](#)
 display for channels, [222](#)
 display frequency span, [279](#)
 display measurements, [312](#), [336](#)
 display order, [700](#)
 display persistence, [251](#)
 display reference, [458](#), [461](#)
 display reset conditions, [128](#)
 display serial number, [175](#)
 display source, [252](#)
 display vectors, [253](#)
 display wave position, [700](#)
 display, clearing, [149](#)
 display, lister, [294](#)
 display, oscilloscope, [239](#), [251](#), [252](#), [253](#), [268](#), [393](#), [447](#)
 display, serial decode bus, [427](#)
 displaying a baseline, [477](#)
 displaying unsynchronized signal, [477](#)
 DNS IP, [37](#)
 domain, [37](#)
 Domain softkey, [38](#)
 driver, printer, [712](#)
 DSO models, [4](#)
 duplicate mnemonics, [805](#)
 duration, [490](#), [491](#), [494](#)
 duration for glitch trigger, [519](#), [520](#), [524](#)
 duration pattern, [492](#)
 duration qualifier, trigger, [490](#), [491](#), [493](#)
 DURation trigger commands, [489](#)
 duration triggering, [468](#)
 duty cycle measurement, [47](#), [312](#), [321](#)

E

EBURst trigger commands, [495](#)
 ECL channel threshold, [695](#)
 ECL threshold voltage for digital channels, [243](#)
 ECL trigger threshold voltage, [741](#)
 edge, [575](#)
 edge activity, [693](#)
 EDGE commands, [660](#)
 edge counter, [574](#)
 edge counter, Nth edge of burst, [496](#)
 edge coupling, [500](#)
 edge define, [475](#), [575](#)
 edge fall time, [322](#)
 edge parameter for delay measurement, [319](#)
 edge preshoot measured, [329](#)
 edge rise time, [334](#)
 edge slope, [503](#)
 edge source, [504](#)
 EDGE trigger commands, [499](#)
 edge triggering, [468](#)
 edges (activity) on digital channels, [142](#)
 edges in measurement, [317](#)
 elapsed time in mask test, [370](#)
 ellipsis, [109](#)
 enable channel labels, [249](#)
 enabling calibration, [214](#)

enabling channel display, 222
 enabling status register bits, 118, 132
 end of string (EOS) terminator, 788
 end of text (EOT) terminator, 788
 end or identify (EOI), 788
 enter pattern, 475
 EOI (end or identify), 788
 EOS (end of string) terminator, 788
 EOT (end of text) terminator, 788
 Epson, 707
 equivalent-time acquisition mode, 182, 187
 erase data, 149, 246
 erase functions, 149
 erase measurements, 714
 erase screen, 701
 ERRor commands, 660
 error frame count (CAN), 422
 error frame count (UART), 440
 error messages, 448, 743
 error number, 448
 error queue, 448, 765
 error, measurement, 312
 ESB (Event Status Bit), 133, 135
 ESE (Standard Event Status Enable Register), 118, 764
 ESR (Standard Event Status Register), 120, 763
 EVENT commands, 660
 event status conditions occurred, 135
 Event Status Enable Register (ESE), 118, 764
 Event Status Register (ESR), 120, 179, 763
 example code, :ACQuire:COMPLete, 184
 example code, :ACQuire:SEGmented, 192
 example code, :ACQuire:TYPE, 197
 example code, :AUToscale, 145
 example code, :CHANnel<n>:LABel, 225
 example code, :CHANnel<n>:PROBe, 227
 example code, :CHANnel<n>:RANGe, 233
 example code, :DIGitize, 150
 example code, :DISPlay:DATA, 248
 example code, :DISPlay:LABel, 249
 example code, :DISPlay:ORDer, 700
 example code, :MEASure:PERiod, 338
 example code, :MEASure:RESults, 331
 example code, :MEASure:TEDGe, 343
 example code, :MTESt, 360
 example code, :POD<n>:THReshold, 395
 example code, :RUN/:STOP, 174
 example code, :SYSTem:SEtUp, 452
 example code, :TIMebase:DElay, 737
 example code, :TIMebase:MODE, 457
 example code, :TIMebase:RANGe, 459
 example code, :TIMebase:REFerence, 461
 example code, :TRIGger:MODE, 473
 example code, :TRIGger:SLOPe, 503
 example code, :TRIGger:SOURce, 504
 example code, :VIEW and :BLANK, 180
 example code, :WAVEform, 639
 example code, :WAVEform:DATA, 626
 example code, :WAVEform:POINts, 630
 example code, :WAVEform:PREAmble, 634
 example code, :WAVEform:SEGmented, 192
 example code, *RST, 130

example programs, 4, 811
 EXE (Execution Error) status bit, 119, 121
 execution error detected in Standard Event Status, 121
 exponential notation, 108
 external glitch trigger source, 525
 external range, 262
 external trigger, 254, 257, 258, 504, 702
 EXternal trigger commands, 254
 external trigger input impedance, 257, 702
 EXternal trigger level, 501
 external trigger overload, 261
 external trigger probe attenuation factor, 258
 external trigger probe ID, 259
 external trigger probe sensing, 703
 external trigger protection, 261
 external trigger signal type, 260
 EXternal trigger source, 504
 external trigger units, 263

F

FAcTION commands, 660
 FAcTors commands, 660
 fail (mask test) output, 376
 failed waveforms in mask test, 368
 failure, self test, 137
 fall time measurement, 312, 322
 falling edge, 475, 575
 Fast Fourier Transform (FFT) functions, 266, 267, 278, 279, 280, 704
 FF values in waveform data, 626
 FFT (Fast Fourier Transform) functions, 266, 267, 278, 279, 280, 704
 FFT (Fast Fourier Transform) operation, 273, 638
 FFT math function, 186
 fifty ohm impedance, disable setting, 451
 FILEname commands, 661
 filename for hardcopy, 708
 filename for recall, 398
 filename for save, 405
 filter for frequency reject, 502
 filter for high frequency reject, 471
 filter for noise reject, 474
 filter used to limit bandwidth, 220, 256
 filters to Fast Fourier Transforms, 280
 find stage in sequence trigger, 576
 fine horizontal adjustment (vernier), 463
 fine vertical adjustment (vernier), 236
 finish pending device operations, 124
 first point displayed, 648
 FLATop window for amplitude measurements, 280
 FLEXRy commands, 661
 FlexRay frame counters, reset, 429
 FLEXRy source, 515
 FLEXRy trigger, 516
 FLEXRy trigger autoseup, 506
 FLEXRy trigger commands, 505
 FlexRay triggering, 468
 format, 628, 633
 FORMat commands, 661
 format for block data, 123
 format for generic video, 591, 595
 format for hardcopy, 706, 709
 format for image, 409
 format for waveform data, 417
 FormattedIO488 object, 49
 formfeed for hardcopy, 282, 286
 formulas for data conversion, 620
 frame, 589
 FRAMe commands, 661
 frame counters (CAN), error, 422
 frame counters (CAN), overload, 423
 frame counters (CAN), reset, 424
 frame counters (CAN), total, 425
 frame counters (FlexRay), null, 428, 430
 frame counters (FlexRay), reset, 429
 frame counters (FlexRay), total, 431
 frame counters (UART), error, 440
 frame counters (UART), reset, 441
 frame counters (UART), Rx frames, 442
 frame counters (UART), Tx frames, 443
 frame ID, FLEXRy frame trigger, 513
 frame type, FLEXRy frame trigger, 514
 framing, 584
 FRAMing commands, 662
 frequency measurement, 47, 312, 323
 frequency resolution, 280
 frequency span of display, 279
 frequency versus dB, 266
 front panel mode, 477
 front panel Single key, 176
 front panel Stop key, 178
 front-panel lock, 449
 full-scale horizontal time, 459, 465
 full-scale vertical axis defined, 274
 function, 180, 267, 268, 272, 273, 274, 275, 276, 278, 279, 280, 704, 705
 FUNCTION commands, 264
 function memory, 177
 function turned on or off, 705
 functions, 638
 functions, erasing, 149

G

g(t) source, first input channel, 270
 g(t) source, math operation, 269
 g(t) source, second input channel, 271
 gateway IP, 37
 general trigger commands, 470
 GENeric, 591, 595
 generic video format, 591, 595
 glitch duration, 524
 glitch qualifier, 523
 glitch source, 525
 GLITCh trigger commands, 517
 glitch trigger duration, 519
 glitch trigger polarity, 522
 glitch trigger source, 519
 GOFT commands, 662
 graphics, 247

graticule area for hardcopy print, [283](#)
 graticule area for saved image, [407](#)
 graticule colors, invert for hardcopy, [287, 711](#)
 graticule colors, invert for image, [410](#)
 graticule data, [247](#)
 grayscale palette for hardcopy, [289](#)
 grayscale palette for image, [411](#)
 grayscale on hardcopy, [710](#)
 greater than qualifier, [523](#)
 greater than time, [490, 494, 519, 524](#)
 GREaterthan commands, [662](#)
 groups of digital channels, [392, 393, 395, 695](#)

H

HANNing window for frequency resolution, [280](#)
 hardcopy, [173, 282](#)
 HARDcopy commands, [281](#)
 hardcopy device, [707](#)
 hardcopy factors, [285, 408](#)
 hardcopy filename, [708](#)
 hardcopy format, [706, 709](#)
 hardcopy formfeed, [286](#)
 hardcopy grayscale, [710](#)
 hardcopy invert graticule colors, [287, 711](#)
 hardcopy layout, [288](#)
 hardcopy palette, [289](#)
 hardcopy print, area, [283](#)
 hardcopy printer driver, [712](#)
 hardware event condition register, [154](#)
 Hardware Event Condition Register (:HWERegister:CONDition), [154](#)
 Hardware Event Condition Register (:OPERRegister:CONDition), [771](#)
 Hardware Event Enable Register (HWEenable), [152](#)
 hardware event event register, [156](#)
 Hardware Event Event Register (:HWERegister[:EVENT]), [156, 770](#)
 head type, probe, [228](#)
 header, [788](#)
 high resolution acquisition type, [620](#)
 high-frequency reject filter, [471, 502](#)
 high-resolution acquisition type, [182](#)
 hold until operation complete, [124](#)
 holdoff time, [472](#)
 holes in waveform data, [626](#)
 horizontal adjustment, fine (vernier), [463](#)
 horizontal position, [464](#)
 horizontal scale, [462, 466](#)
 horizontal scaling, [633](#)
 horizontal time, [459, 465, 715](#)
 hostname, [37](#)
 HWEenable (Hardware Event Enable Register), [152](#)
 HWERegister:CONDition (Hardware Event Condition Register), [154, 771](#)
 HWERegister[:EVENT] (Hardware Event Event Register), [156, 770](#)
 I/O softkey, [37, 38](#)
 I1080L50HZ, [591, 595](#)
 I1080L60HZ, [591, 595](#)
 I2S alignment, [528](#)
 I2S audio channel, [529](#)
 I2S clock slope, [530](#)
 I2S CLOCk source, [537](#)
 I2S commands, [663](#)
 I2S DATA source, [538](#)
 I2S pattern data, [531](#)
 I2S pattern format, [533](#)
 I2S range, [534](#)
 I2S receiver width, [536](#)
 I2S serial decode base, [432](#)
 I2S transmit word size, [542](#)
 I2S trigger commands, [526](#)
 I2S trigger operator, [540](#)
 I2S triggering, [468](#)
 I2S word select (WS) low, [543](#)
 I2S word select (WS) source, [539](#)
 ID commands, [663](#)
 id mode, [483](#)
 identification number, [122](#)
 identification of options, [125](#)
 identifier, [482](#)
 identifier, LIN, [555](#)
 idle, [497](#)
 IDLE commands, [663](#)
 idle until operation complete, [124](#)
 IDN (Identification Number), [122](#)
 IEEE 488.2 standard, [116](#)
 IGCOLORS commands, [664](#)
 IIC address, [545](#)
 IIC clock, [548](#)
 IIC commands, [663](#)
 IIC data, [546, 549](#)
 IIC data 2, [547](#)
 IIC serial decode address field size, [433](#)
 IIC trigger commands, [544](#)
 IIC trigger qualifier, [550](#)
 IIC trigger type, [551](#)
 IIC triggering, [468](#)
 IMAGE commands, [664](#)
 image format, [409](#)
 image invert graticule colors, [410](#)
 image memory, [177, 252](#)
 image palette, [411](#)
 image, recall, [399](#)
 image, save, [406](#)
 image, save with inksaver, [410](#)
 impedance, [223](#)
 IMPedance commands, [664](#)
 impedance for external trigger input, [257, 702](#)
 infinity representation, [808](#)
 initialization, [46, 49](#)
 initialize, [128](#)
 initialize label list, [250](#)
 initiate acquisition, [150](#)
 inksaver, save image with, [410](#)
 input, [257, 702](#)
 input coupling for channels, [221](#)
 input impedance for channels, [223, 697](#)
 input impedance for external trigger, [257, 702](#)
 input inversion for specified channel, [224](#)
 insert label, [225](#)
 installed options identified, [125](#)
 instruction header, [788](#)
 instrument number, [122](#)
 instrument options identified, [125](#)
 instrument requests service, [135](#)
 instrument serial number, [175](#)
 instrument settings, [282](#)
 instrument status, [56](#)
 instrument type, [122](#)
 integrate math function, [266, 273, 638](#)
 INTEgrate source for function, [278, 704](#)
 INTERN files, [252](#)
 internal low-pass filter, [220, 256](#)
 introduction to :ACQuire commands, [181](#)
 introduction to :BUS<n> commands, [199](#)
 introduction to :CALibrate commands, [207](#)
 introduction to :CHANnel<n> commands, [218](#)
 introduction to :DIGital<n> commands, [237](#)
 introduction to :DISPlay commands, [244](#)
 introduction to :EXternal commands, [254](#)
 introduction to :FUNction commands, [266](#)
 introduction to :HARDcopy commands, [282](#)
 introduction to :LISTer commands, [292](#)
 introduction to :MARKer commands, [296](#)
 introduction to :MEASure commands, [312](#)
 introduction to :POD<n> commands, [392](#)
 introduction to :RECall commands, [397](#)
 introduction to :SAVE commands, [404](#)
 introduction to :SBUS commands, [421](#)
 introduction to :SYSTem commands, [445](#)
 introduction to :TIMEbase commands, [456](#)
 introduction to :TRIGger commands, [467](#)
 introduction to :WAVEform commands, [618](#)
 introduction to common (*) commands, [116](#)
 introduction to root (:): commands, [141](#)
 invert graticule colors for hardcopy, [287, 711](#)
 invert graticule colors for image, [410](#)
 inverted masks, bind levels, [385](#)
 inverting input for channels, [224](#)
 IO library, referencing, [48](#)
 IP address, [37](#)
 IP Options softkey, [38](#)

K

key disable, [449](#)
 key press detected in Standard Event Status Register, [121](#)
 knob disable, [449](#)
 known state, [128](#)

L

label, [240, 694](#)
 label command, bus, [205](#)
 LABEL commands, [664](#)

Index

label list, 225, 250
labels, 225, 249, 250
labels to store calibration information, 210
labels, specifying, 244
LAN interface, 37, 40
LAN Settings softkey, 38
landscape layout for hardcopy, 288
language for program examples, 45
LaserJet, 707
layout for hardcopy, 288
leakage into peak spectrum, 280
learn string, 123, 452
least significant byte first, 624
left reference, 461
legal values for channel offset, 226
legal values for frequency span, 279
legal values for offset, 272, 275
LENGth commands, 664
length for waveform data, 418
less than qualifier, 523
less than time, 491, 494, 520, 524
LESthan commands, 664
LEVel commands, 665
level for trigger voltage, 501, 521
LF coupling, 500
license information, 125
limits for line number, 591
LIN acknowledge, 560
LIN baud rate, 561
LIN identifier, 555
LIN pattern data, 556
LIN pattern format, 559
LIN serial decode bus parity bits, 434
LIN source, 562
LIN standard, 563
LIN sync break, 564
LIN trigger, 558, 565
LIN trigger commands, 553
LIN trigger definition, 740
LIN triggering, 468
line glitch trigger source, 525
line number for TV trigger, 591
line terminator, 108
LINE trigger level, 501
LINE trigger source, 504
list of channel labels, 250
LISTer commands, 292, 665
lister display, 294
load utilization (CAN), 426
local lockout, 449
lock, 449
LOCK commands, 665
lock mask to signal, 375
lock, analog channel protection, 451
lockout message, 449
logic level activity, 693
long form, 788
LOWer commands, 665
lower threshold, 327
lower threshold channel, M1553 trigger, 570
lower threshold voltage for measurement, 713
lowercase characters in commands, 787

low-frequency reject filter, 502
low-pass filter used to limit bandwidth, 220, 256
LRN (Learn Device Setup), 123
lsbfirst, 624

M

M1553 commands, 665
M1553 trigger commands, 566
M1553 trigger type, 572
magnitude of occurrence, 344
main sweep range, 464
main time base, 737
main time base mode, 457
making measurements, 312
MAN option for probe sense, 698, 703
manual cursor mode, 297
MARKer commands, 295
marker mode, 303
marker position, 304
marker readout, 719, 720
marker set for voltage measurement, 725, 726
marker sets start time, 716
marker time, 715
markers for delta voltage measurement, 724
markers track measurements, 336
markers, command overview, 296
markers, mode, 297
markers, time at start, 720
markers, time at stop, 719
markers, X delta, 302
markers, X1 position, 298
markers, X1Y1 source, 299
markers, X2 position, 300
markers, X2Y2 source, 301
markers, Y delta, 305
markers, Y1 position, 303
markers, Y2 position, 304
mask, 118, 132, 475, 492
mask command, bus, 206
MASK commands, 665
mask statistics, reset, 369
mask test commands, 358
Mask Test Event Enable Register (MTEenable), 159
mask test event event register, 161
Mask Test Event Event Register (:MTERegister[:EVENT]), 161, 772
mask test output, 376
mask test run mode, 377
mask test termination conditions, 377
mask test, enable/disable, 374
mask, delete, 373
mask, get as binary block data, 372
mask, load from binary block data, 372
mask, lock to signal, 375
mask, recall, 400
mask, save, 412, 413
masks, bind levels, 385
master summary status bit, 135
math function, stop displaying, 148
math operations, 266
MAV (Message Available), 117, 133, 135
maximum duration, 490, 491, 520
maximum position, 458
maximum range for zoomed window, 465
maximum scale for zoomed window, 466
maximum vertical value measurement, 349
maximum vertical value, time of, 356, 717
MEASure commands, 306
measure mask test failures, 378
measure overshoot, 325
measure period, 327
measure phase between channels, 328
measure preshoot, 329
measure start voltage, 725
measure stop voltage, 726
measure value at a specified time, 354
measure value at top of waveform, 355
measurement error, 312
measurement record, 450, 631
measurement setup, 312, 337
measurement source, 337
measurement statistics results, 331
measurements, average value, 347
measurements, base value, 348
measurements, built-in, 47
measurements, clear, 314, 714
measurements, command overview, 312
measurements, counter, 315
measurements, dc RMS, 353
measurements, definition setup, 317
measurements, delay, 319
measurements, duty cycle, 321
measurements, fall time, 322
measurements, frequency, 323
measurements, how autoscale affects, 144
measurements, lower threshold level, 713
measurements, maximum vertical value, 349
measurements, maximum vertical value, time of, 356, 717
measurements, minimum vertical value, 350
measurements, minimum vertical value, time of, 357, 718
measurements, overshoot, 325
measurements, period, 327
measurements, phase, 328
measurements, preshoot, 329
measurements, pulse width, negative, 324
measurements, pulse width, positive, 330
measurements, ratio of AC RMS values, 352
measurements, resetting, 149
measurements, rise time, 334
measurements, show, 336
measurements, source channel, 337
measurements, standard deviation, 335
measurements, start marker time, 719
measurements, stop marker time, 720
measurements, thresholds, 716
measurements, time between start and stop markers, 715
measurements, time between trigger and edge, 342

measurements, time between trigger and vertical value, [344](#)
 measurements, time between trigger and voltage level, [721](#)
 measurements, upper threshold value, [723](#)
 measurements, vertical amplitude, [346](#)
 measurements, vertical peak-to-peak, [351](#)
 measurements, voltage difference, [724](#)
 memory setup, [131, 452](#)
 merge, [158](#)
 message available bit, [135](#)
 message available bit clear, [117](#)
 message displayed, [135](#)
 message error, [743](#)
 message queue, [762](#)
 messages ready, [135](#)
 midpoint of thresholds, [327](#)
 MIL-STD 1553 serial decode base, [435](#)
 MIL-STD 1553 triggering, [468](#)
 minimum duration, [490, 491, 494, 519](#)
 minimum vertical value measurement, [350](#)
 minimum vertical value, time of, [357, 718](#)
 mixed-signal oscilloscopes, [4](#)
 mnemonics, duplicate, [805](#)
 mode, [187, 196, 297, 457, 592](#)
 MODE commands, [667](#)
 mode, serial decode, [436](#)
 model number, [122](#)
 models, oscilloscope, [3](#)
 modes for triggering, [473](#)
 Modify softkey, [38](#)
 monochrome palette for image, [411](#)
 most significant byte first, [624](#)
 move, [266](#)
 move cursors, [719, 720](#)
 msbfirst, [624](#)
 MSG (Message), [133, 135](#)
 MSO models, [4](#)
 MSS (Master Summary Status), [135](#)
 MTEEnable (Mask Test Event Enable Register), [159](#)
 MTERegister[:EVENT] (Mask Test Event Event Register), [161, 772](#)
 MTESt commands, [358](#)
 multiple commands, [806](#)
 multiple queries, [55](#)
 multiply math function, [266, 273, 638](#)
 multiply math function as g(t) source, [269](#)

N

name channels, [225](#)
 name list, [250](#)
 negative glitch trigger polarity, [522](#)
 negative pulse width, [324](#)
 negative pulse width measurement, [47](#)
 negative slope, [503, 582](#)
 negative slope, Nth edge in burst, [498](#)
 negative TV trigger polarity, [593](#)
 new line (NL) terminator, [108, 788](#)
 NL (new line) terminator, [108, 788](#)
 noise reject filter, [474](#)

non-core commands, [786](#)
 non-interlaced GENeric mode, [595](#)
 non-volatile memory, label list, [205, 240, 250](#)
 normal acquisition type, [182, 619](#)
 normal trigger sweep mode, [467](#)
 notices, [2](#)
 NR1 number format, [108](#)
 NR3 number format, [108](#)
 Nth edge burst triggering, [468](#)
 Nth edge in a burst idle, [497](#)
 Nth edge in burst slope, [498](#)
 Nth edge of burst counter, [496](#)
 NTSC, [591, 595](#)
 null frame count (FlexRay), [428](#)
 NULL string, [447](#)
 number format, [108](#)
 number of points, [188, 629, 631](#)
 number of time buckets, [629, 631](#)
 numeric variables, [54](#)
 numeric variables, reading query results into multiple, [56](#)
 nwidth, [324](#)

O

obsolete and discontinued commands, [687](#)
 obsolete commands, [786](#)
 occurrence reported by magnitude, [721](#)
 offset, [266](#)
 OFFSet commands, [668](#)
 offset value for channel voltage, [226](#)
 offset value for selected function, [272, 275](#)
 one values in waveform data, [626](#)
 OPC (Operation Complete) command, [124](#)
 OPC (Operation Complete) status bit, [119, 121](#)
 OPEE (Operation Status Enable Register), [163](#)
 Open method, [49](#)
 operating configuration, [123, 452](#)
 operating state, [131](#)
 OPERation commands, [669](#)
 operation complete, [124](#)
 operation status condition register, [165](#)
 Operation Status Condition Register (:OPERRegister:CONDition), [165, 767](#)
 operation status conditions occurred, [135](#)
 Operation Status Enable Register (OPEE), [163](#)
 operation status event register, [167](#)
 Operation Status Event Register (:OPERRegister[:EVENT]), [167, 766](#)
 operation, math, [266](#)
 operations for function, [273](#)
 OPERRegister:CONDition (Operation Status Condition Register), [165, 767](#)
 OPERRegister[:EVENT] (Operation Status Event Register), [167, 766](#)
 OPT (Option Identification), [125](#)
 optional syntax terms, [108](#)
 options, [125](#)
 order of digital channels on display, [700](#)
 order of output, [624](#)
 oscilloscope connection, opening, [49](#)
 oscilloscope connection, verifying, [39](#)

oscilloscope external trigger, [254](#)
 oscilloscope models, [3](#)
 oscilloscope rate, [195](#)
 oscilloscope, connecting, [37](#)
 oscilloscope, initialization, [46](#)
 oscilloscope, operation, [4](#)
 oscilloscope, program structure, [46](#)
 oscilloscope, setting up, [37](#)
 oscilloscope, setup, [50](#)
 OUTPut commands, [669](#)
 output messages ready, [135](#)
 output queue, [124, 761](#)
 output queue clear, [117](#)
 output sequence, [624](#)
 output, mask test, [376](#)
 overlapped commands, [809](#)
 overload, [232, 261](#)
 Overload Event Enable Register (OVL), [169](#)
 Overload Event Register (:OVLRegister), [769](#)
 Overload Event Register (OVLr), [171](#)
 overload frame count (CAN), [423](#)
 overload protection, [169, 171](#)
 overshoot of waveform, [325](#)
 overvoltage, [232, 261](#)
 OVL (Overload Event Enable Register), [169](#)
 OVLr (Overload Event Register), [171](#)
 OVLr bit, [156, 165, 167](#)
 OVLRegister (Overload Event Register), [769](#)

P

P1080L24HZ, [591, 595](#)
 P1080L25HZ, [591, 595](#)
 P1080L50HZ, [595](#)
 P1080L60HZ, [568, 595](#)
 P480L60HZ, [591, 595](#)
 P720L60HZ, [591, 595](#)
 PAL, [591, 595](#)
 PALette commands, [669](#)
 palette for hardcopy, [289](#)
 palette for image, [411](#)
 PAL-M, [591, 595](#)
 parameters for delay measurement, [319](#)
 parametric measurements, [312](#)
 parity, [604](#)
 parity bits, LIN serial decode bus, [434](#)
 PARity commands, [669](#)
 parser, [141, 806](#)
 pass (mask test) output, [376](#)
 pass, self test, [137](#)
 path information, recall, [401](#)
 path information, save, [414](#)
 pattern, [475, 480, 482, 492, 545, 546, 547, 577, 585](#)
 pattern and edge, [475](#)
 PATtern commands, [669](#)
 pattern data, I2S, [531](#)
 pattern data, LIN, [556](#)
 pattern duration, [490, 491, 519, 520](#)
 pattern format, I2S, [533](#)
 pattern format, LIN, [559](#)
 pattern length, [481, 558](#)

Index

pattern trigger, 475
pattern triggering, 468
pattern width, 586
peak data, 620
peak detect, 196
peak detect acquisition type, 182, 620
peaks, 266
peak-to-peak vertical value measurement, 351
pending operations, 124
percent of waveform overshoot, 325
percent thresholds, 317
period measured to calculate phase, 328
period measurement, 47, 312, 327
persistence, waveform, 244, 251
phase measured between channels, 328
phase measurements, 342
pixel memory, 252
pixel memory, saving display to, 158
PLL Locked bit, 154, 165
pod, 392, 393, 394, 395, 638, 695
POD commands, 392
POD data format, 623
pod, stop displaying, 148
points, 188, 629, 631
POINts commands, 670
points in waveform data, 619
polarity, 593, 605
POLarity commands, 670
polarity for glitch trigger, 522
polling synchronization with timeout, 778
polling wait, 776
PON (Power On) status bit, 119, 121
portrait layout for hardcopy, 288
position, 241, 300, 458, 464
POStion commands, 670
position cursors, 719, 720
position in zoomed view, 464
position waveforms, 700
positive glitch trigger polarity, 522
positive pulse width, 330
positive pulse width measurement, 47
positive slope, 503, 582
positive slope, Nth edge in burst, 498
positive TV trigger polarity, 593
positive width, 330
preamble data, 633
preamble metadata, 618
precision analysis, 450
precision analysis record, 631
predefined logic threshold, 695
predefined threshold voltages, 741
present working directory, recall operations, 401
present working directory, save operations, 414
preset conditions, 128
preshoot measured on waveform, 329
previously stored configuration, 127
print command, 173
print job, start, 291
print mask test failures, 379
print query, 735
printer, 707

printer driver for hardcopy, 712
printer hardcopy format, 709
printer, active, 284
printing, 282
printing in grayscale, 710
probe, 501
probe attenuation affects channel voltage range, 233
probe attenuation factor (external trigger), 258
probe attenuation factor for selected channel, 227
PROBe commands, 671
probe head type, 228
probe ID, 229, 259
probe sense for oscilloscope, 698, 703
probe skew value, 230, 696
process sigma, mask test run, 382
program data, 788
program data syntax rules, 790
program initialization, 46
program message, 49, 116
program message syntax, 787
program message terminator, 788
program structure, 46
programming examples, 4, 811
protecting against calibration, 214
protection, 169, 171, 232, 261
PROTection commands, 671
protection lock, 451
pulse width, 324, 330
pulse width duration trigger, 519, 520, 524
pulse width measurement, 47, 312
pulse width trigger, 474
pulse width trigger level, 521
pulse width triggering, 468
PWD commands, 671
pwidth, 330

Q

qualifier, 524
QUALifier commands, 671
qualifier, trigger duration, 490, 491, 493
queries, multiple, 55
query error detected in Standard Event Status, 121
query responses, block data, 54
query responses, reading, 53
query results, reading into numeric variables, 54
query results, reading into string variables, 54
query return values, 808
query setup, 282, 296, 312, 452
query subsystem, 199, 237, 266
querying setup, 219
querying the subsystem, 469
queues, clearing, 773
quick reference, commands, 59
quoted ASCII string, 109
QYE (Query Error) status bit, 119, 121

R

range, 266, 465
RANGe commands, 671
range for channels, 233
range for duration trigger, 494
range for external trigger, 262
range for full-scale vertical axis, 274
range for glitch trigger, 524
range for time base, 459
range of offset values, 226
range qualifier, 523
range, I2S, 534
ranges, value, 109
rate, 195
ratio of AC RMS values measured between channels, 352
raw acquisition record, 631
RCL (Recall), 127
read configuration, 123
read trace memory, 247
ReadIEEEBlock method, 49, 53, 55
ReadList method, 49, 53
ReadNumber method, 49, 53
readout, 715
ReadString method, 49, 53
real-time acquisition mode, 182, 187
recall, 127, 397, 452
RECall commands, 397
recall filename, 398
recall image, 399
recall mask, 400
recall path information, 401
recall setup, 402
recalling and saving data, 244
receiver width, I2S, 536
RECTangular window for transient signals, 280
reference, 266, 461
reference clock, 460
REFerence commands, 672
reference for time base, 737
reference signal (10 MHz), 189
reference signal mode, 460
registers, 120, 127, 131, 143, 152, 154, 156, 159, 161, 163, 165, 167, 169, 171
registers, clearing, 773
reject filter, 502
reject high frequency, 471
reject noise, 474
remote control examples, 811
Remote Terminal Address (RTA), M1553 trigger, 569
remove cursor information, 297
remove labels, 249
remove message from display, 447
reorder channels, 144
repetitive acquisitions, 174
report errors, 448
report transition, 342, 344
reporting status, 751
reporting the setup, 469
request service, 135

Request-for-OPC flag clear, 117
 reset, 128, 578
 RESet commands, 672
 reset conditions, 128
 reset mask statistics, 369
 reset measurements, 149, 246
 resolution of printed copy, 710
 resource session object, 49
 ResourceManager object, 49
 restore configurations, 123, 127, 131, 452
 restore labels, 249
 restore setup, 127
 return values, query, 808
 returning acquisition type, 196
 returning number of data points, 188
 right reference, 461
 rise time measurement, 312
 rise time of positive edge, 334
 rising edge, 475, 575
 RMODe commands, 672
 RMS value measurement, 353
 roll time base mode, 457
 root (:) commands, 139, 141
 root level commands, 112
 RQL (Request Control) status bit, 119, 121
 RQS (Request Service), 135
 RS-232/UART triggering, 469
 RST (Reset), 128
 rules, tree traversal, 806
 rules, truncation, 788
 RUMode commands, 672
 run, 136, 174
 Run bit, 165, 167
 run mode, mask test, 377
 running configuration, 131, 452
 Rx frame count (UART), 442
 Rx source, 607

S

sample rate, 195
 sampled data, 699
 sampled data points, 626
 SAMPlEpoint commands, 673
 SAV (Save), 131
 save, 131, 404
 SAVE commands, 403, 673
 save filename, 405
 save image, 406
 save image with inksaver, 410
 save mask, 412, 413
 save mask test failures, 380
 save path information, 414
 save setup, 415
 SAVE TO INTERN, 158
 save waveform data, 416
 save waveforms to pixel memory, 158
 saved image, area, 407
 saving and recalling data, 244
 SBUS commands, 420
 scale, 276, 462, 466
 SCALe commands, 674
 scale factors output on hardcopy, 285, 408
 scale for channels, 234
 scale units for channels, 235
 scale units for external trigger, 263
 scaling display factors, 227
 SCPI commands, 57
 scratch measurements, 714
 screen area for hardcopy print, 283
 screen area for saved image, 407
 screen data, 247
 SECAM, 591, 595
 seconds per division, 462
 SEGMeNted commands, 674
 segmented waveform save option, 419
 segments, analyze, 190
 segments, count of waveform, 636
 segments, setting number of memory, 191
 segments, setting the index, 192
 segments, time tag, 637
 select measurement channel, 337
 self-test, 137
 sensing a channel probe, 698
 sensing an external trigger probe, 703
 sensitivity of oscilloscope input, 227
 sequence, 576, 577, 578
 sequence trigger, 580
 SEQuence trigger commands, 573
 sequence triggering, 469
 sequencer edge counter, 574
 sequencer timer, 579
 sequential commands, 809
 serial clock, 548, 587
 serial data, 549, 588
 serial decode bus, 421
 serial decode bus display, 427
 serial decode mode, 436
 serial frame, 589
 serial number, 175
 service request, 135
 Service Request Enable Register (SRE), 133, 759
 set, 128
 set center frequency, 267
 set conditions, 144
 set cursors, 719, 720
 set date, 446
 set delay, 144
 set thresholds, 144
 set time, 454
 set time/div, 144
 set up oscilloscope, 37
 setting digital display, 239
 setting digital label, 205, 240
 setting digital position, 241
 setting digital threshold, 243
 setting display, 268
 setting external trigger level, 254
 setting impedance for channels, 223
 setting inversion for channels, 224
 setting pod display, 393
 setting pod size, 394
 setting pod threshold, 395
 settings, 127, 131
 settings, instrument, 282
 setup, 182, 199, 219, 237, 244, 266, 282, 452
 SETup commands, 674
 setup configuration, 127, 131, 452
 setup defaults, 128
 setup memory, 127
 setup reported, 469
 setup, recall, 402
 setup, save, 415
 short form, 4, 788
 show channel labels, 249
 show measurements, 312, 336
 SICL example in C, 891
 SICL example in Visual Basic, 900
 SICL examples, 891
 sigma, mask test run, 382
 SIGNal commands, 675
 signal type, 231, 260
 signed data, 622
 simple command headers, 789
 single acquisition, 176
 single-ended probe heads, 228
 single-ended signal type, 231, 260
 single-shot DUT, synchronizing with, 780
 size, 242, 394
 SIZE commands, 675
 skew, 230, 696
 slope, 503, 582
 slope (direction) of waveform, 721
 SLOPe commands, 675
 slope not valid in TV trigger mode, 503
 slope of edge, 575
 slope parameter for delay measurement, 319
 slope, Nth edge in burst, 498
 smoothing acquisition type, 620
 software version, 122
 source, 252, 266, 337, 486, 562, 638
 SOURce commands, 675
 source for function, 277, 278, 704
 source for trigger, 504
 source for TV trigger, 594
 source, automask, 364
 source, FLEXray, 515
 source, mask test, 390
 SOURce1 commands, 676
 SOURce2 commands, 676
 span, 266
 span of frequency on display, 279
 specify measurement, 337
 SPI, 582, 583, 585
 SPI commands, 676
 SPI decode bit order, 437
 SPI decode word width, 438
 SPI trigger, 584, 586
 SPI trigger clock, 587
 SPI trigger commands, 581
 SPI trigger data, 588
 SPI trigger frame, 589
 SPI triggering, 469
 square root math function, 273

Index

- SRE (Service Request Enable Register), [133](#), [759](#)
 - SRQ (Service Request interrupt), [152](#), [159](#), [163](#)
 - STANdard commands, [676](#)
 - standard deviation measured on waveform, [335](#)
 - Standard Event Status Enable Register (ESE), [118](#), [764](#)
 - Standard Event Status Register (ESR), [120](#), [763](#)
 - standard for video, [595](#)
 - standard, LIN, [563](#)
 - start acquisition, [136](#), [150](#), [174](#), [176](#)
 - start and stop edges, [317](#)
 - STARt commands, [676](#)
 - start cursor, [719](#)
 - start measurement, [312](#)
 - start print job, [291](#)
 - start time, [524](#), [719](#)
 - start time marker, [716](#)
 - state memory, [131](#)
 - state of instrument, [123](#), [452](#)
 - STATistics commands, [677](#)
 - statistics increment, [340](#)
 - statistics reset, [341](#)
 - statistics results, [331](#)
 - statistics, type of, [339](#)
 - status, [134](#), [177](#), [179](#)
 - Status Byte Register (STB), [132](#), [134](#), [135](#), [757](#)
 - STATus commands, [677](#)
 - status data structure clear, [117](#)
 - status registers, [56](#)
 - status reporting, [751](#)
 - STB (Status Byte Register), [132](#), [134](#), [135](#), [757](#)
 - step size for frequency span, [279](#)
 - stop, [150](#), [178](#)
 - stop acquisition, [178](#)
 - STOP commands, [677](#)
 - stop cursor, [720](#)
 - stop displaying channel, [148](#)
 - stop displaying math function, [148](#)
 - stop displaying pod, [148](#)
 - stop on mask test failure, [381](#)
 - stop time, [524](#), [720](#)
 - storage, [131](#)
 - store instrument setup, [123](#), [131](#)
 - store setup, [131](#)
 - store waveforms to pixel memory, [158](#)
 - storing calibration information, [210](#)
 - string variables, [54](#)
 - string variables, reading multiple query results into, [55](#)
 - string variables, reading query results into multiple, [55](#)
 - string, quoted ASCII, [109](#)
 - subnet mask, [37](#)
 - subsource, waveform source, [642](#)
 - subsystem commands, [112](#), [806](#)
 - subtract math function, [266](#), [273](#), [638](#)
 - subtract math function as g(t) source, [269](#)
 - sweep mode, trigger, [467](#), [477](#)
 - sweep speed set to fast to measure fall time, [322](#)
 - sweep speed set to fast to measure rise time, [334](#)
 - switch disable, [449](#)
 - switch, calibration protect, [214](#)
 - sync break, LIN, [564](#)
 - sync frame count (FlexRay), [430](#)
 - syntax elements, [108](#)
 - syntax rules, program data, [790](#)
 - syntax, optional terms, [108](#)
 - syntax, program message, [787](#)
 - SYSTem commands, [445](#)
 - system commands, [446](#), [447](#), [448](#), [449](#), [452](#), [454](#)
 - system commands introduction, [445](#)
- ## T
- tdelta, [715](#)
 - tedge, [342](#)
 - telnet ports 5024 and 5025, [626](#)
 - Telnet sockets, [57](#)
 - temporary message, [447](#)
 - TER (Trigger Event Register), [179](#), [760](#)
 - termination conditions, mask test, [377](#)
 - test sigma, mask test run, [382](#)
 - test, self, [137](#)
 - text, writing to display, [447](#)
 - threshold, [243](#), [395](#), [695](#), [741](#)
 - THReshold commands, [678](#)
 - threshold voltage (lower) for measurement, [713](#)
 - threshold voltage (upper) for measurement, [723](#)
 - thresholds, [317](#), [716](#)
 - thresholds used to measure period, [327](#)
 - thresholds, how autoscale affects, [144](#)
 - TIFF image format, [409](#)
 - time base, [457](#), [458](#), [459](#), [461](#), [462](#), [737](#)
 - time base commands introduction, [456](#)
 - time base reset conditions, [128](#)
 - time base window, [464](#), [465](#), [466](#)
 - time between points, [715](#)
 - time buckets, [184](#), [185](#)
 - TIME commands, [678](#)
 - time delay, [737](#)
 - time delta, [715](#)
 - time difference between data points, [646](#)
 - time duration, [490](#), [491](#), [494](#), [524](#)
 - time holdoff for trigger, [472](#)
 - time interval, [342](#), [344](#), [715](#)
 - time interval between trigger and occurrence, [721](#)
 - time marker sets start time, [716](#)
 - time per division, [459](#)
 - time record, [280](#)
 - time specified, [354](#)
 - time, calibration, [216](#)
 - time, mask test run, [383](#)
 - time, start marker, [719](#)
 - time, stop marker, [720](#)
 - time, system, [454](#)
 - time/div, how autoscale affects, [144](#)
 - time-at-max measurement, [717](#)
 - time-at-min measurement, [718](#)
 - TIMEbase commands, [455](#)
 - timebase vernier, [463](#)
 - TIMEbase:MODE, [52](#)
 - time-ordered label list, [250](#)
 - timeout, [583](#)
 - timer, [579](#)
 - timing measurement, [312](#)
 - title channels, [225](#)
 - title, mask test, [391](#)
 - tolerance, automask, [366](#), [367](#)
 - top of waveform value measured, [355](#)
 - TOTal commands, [678](#)
 - total frame count (CAN), [425](#)
 - total frame count (FlexRay), [431](#)
 - total waveforms in mask test, [371](#)
 - trace memories, how autoscale affects, [144](#)
 - trace memory, [177](#), [180](#)
 - trace memory data, [247](#)
 - track measurements, [336](#)
 - trademarks, [2](#)
 - transfer instrument state, [123](#), [452](#)
 - transmit, [247](#)
 - transmit word size, I2S, [542](#)
 - tree traversal rules, [806](#)
 - tree, command, [791](#)
 - TRG (Trigger), [133](#), [135](#), [136](#)
 - TRIG OUT BNC, [211](#)
 - trigger (external) input impedance, [257](#), [702](#)
 - trigger armed event register, [165](#), [167](#)
 - trigger burst, UART, [601](#)
 - TRIGger CAN commands, [478](#)
 - trigger channel source, [525](#), [594](#)
 - TRIGger commands, [467](#), [678](#)
 - TRIGger commands, general, [470](#)
 - trigger data, UART, [602](#)
 - trigger duration, [490](#), [491](#)
 - TRIGger DURation commands, [489](#)
 - TRIGger EBURst commands, [495](#)
 - trigger edge, [575](#)
 - TRIGger EDGE commands, [499](#)
 - trigger edge coupling, [500](#)
 - trigger edge slope, [503](#)
 - trigger event bit, [179](#)
 - Trigger Event Register (TER), [760](#)
 - TRIGger FLEXray commands, [505](#)
 - TRIGger GLITCh commands, [517](#)
 - trigger holdoff, [472](#)
 - TRIGger I2S commands, [526](#)
 - trigger idle, UART, [603](#)
 - TRIGger IIC commands, [544](#)
 - trigger level constants, [227](#)
 - trigger level voltage, [501](#)
 - TRIGger LIN commands, [553](#)
 - TRIGger M1553 commands, [566](#)
 - trigger occurred, [135](#)
 - trigger pattern, [475](#), [492](#)
 - trigger qualifier, [493](#)
 - trigger qualifier, UART, [606](#)
 - trigger reset conditions, [128](#)
 - TRIGger SEQuence commands, [573](#)

trigger SPI clock slope, [582](#)
 TRIGger SPI commands, [581](#)
 trigger status bit, [179](#)
 trigger sweep mode, [467](#)
 TRIGger TV commands, [590](#)
 trigger type, UART, [609](#)
 TRIGger UART commands, [596](#)
 TRIGger USB commands, [611](#)
 trigger, CAN, [487](#)
 trigger, CAN acknowledge, [738](#)
 trigger, CAN pattern data, [480](#)
 trigger, CAN pattern data length, [481](#)
 trigger, CAN pattern ID, [482](#)
 trigger, CAN pattern ID mode, [483](#)
 trigger, CAN sample point, [484](#)
 trigger, CAN signal baudrate, [485](#)
 trigger, CAN signal definition, [739](#)
 trigger, CAN source, [486](#)
 trigger, duration greater than, [490](#)
 trigger, duration less than, [491](#)
 trigger, duration pattern, [492](#)
 trigger, duration qualifier, [493](#)
 trigger, duration range, [494](#)
 trigger, edge coupling, [500](#)
 trigger, edge level, [501](#)
 trigger, edge reject, [502](#)
 trigger, edge slope, [503](#)
 trigger, edge source, [504](#)
 trigger, FLEXray, [516](#)
 trigger, FLEXray autoseup, [506](#)
 trigger, FLEXray error, [509](#)
 trigger, FLEXray event, [510](#)
 trigger, FLEXray source, [515](#)
 trigger, glitch greater than, [519](#)
 trigger, glitch less than, [520](#)
 trigger, glitch level, [521](#)
 trigger, glitch polarity, [522](#)
 trigger, glitch qualifier, [523](#)
 trigger, glitch range, [524](#)
 trigger, glitch source, [525](#)
 trigger, high frequency reject filter, [471](#)
 trigger, holdoff, [472](#)
 trigger, I2S, [540](#)
 trigger, I2S alignment, [528](#)
 trigger, I2S audio channel, [529](#)
 trigger, I2S clock slope, [530](#)
 trigger, I2S CLOcksource, [537](#)
 trigger, I2S DATA source, [538](#)
 trigger, I2S pattern data, [531](#)
 trigger, I2S pattern format, [533](#)
 trigger, I2S range, [534](#)
 trigger, I2S receiver width, [536](#)
 trigger, I2S transmit word size, [542](#)
 trigger, I2S word select (WS) low, [543](#)
 trigger, I2S word select (WS) source, [539](#)
 trigger, IIC clock source, [548](#)
 trigger, IIC data source, [549](#)
 trigger, IIC pattern address, [545](#)
 trigger, IIC pattern data, [546](#)
 trigger, IIC pattern data 2, [547](#)
 trigger, IIC qualifier, [550](#)
 trigger, IIC signal baudrate, [561](#)

trigger, IIC type, [551](#)
 trigger, LIN, [565](#)
 trigger, LIN pattern data, [556](#)
 trigger, LIN pattern data length, [558](#)
 trigger, LIN pattern format, [559](#)
 trigger, LIN sample point, [560](#)
 trigger, LIN signal definition, [740](#)
 trigger, LIN source, [562](#)
 trigger, mode, [473](#)
 trigger, noise reject filter, [474](#)
 trigger, Nth edge in burst slope, [498](#)
 trigger, Nth edge of burst count, [496](#)
 trigger, pattern, [475](#)
 trigger, sequence, [580](#)
 trigger, sequence count, [574](#)
 trigger, sequence edge, [575](#)
 trigger, sequence find, [576](#)
 trigger, sequence pattern, [577](#)
 trigger, sequence reset, [578](#)
 trigger, sequence timer, [579](#)
 trigger, SPI clock slope, [582](#)
 trigger, SPI clock source, [587](#)
 trigger, SPI clock timeout, [583](#)
 trigger, SPI data source, [588](#)
 trigger, SPI frame source, [589](#)
 trigger, SPI framing, [584](#)
 trigger, SPI pattern data, [585](#)
 trigger, SPI pattern width, [586](#)
 trigger, sweep, [477](#)
 trigger, threshold, [741](#)
 trigger, TV line, [591](#)
 trigger, TV mode, [592, 742](#)
 trigger, TV polarity, [593](#)
 trigger, TV source, [594](#)
 trigger, TV standard, [595](#)
 trigger, UART base, [598](#)
 trigger, UART baudrate, [599](#)
 trigger, UART bit order, [600](#)
 trigger, UART parity, [604](#)
 trigger, UART polarity, [605](#)
 trigger, UART Rx source, [607](#)
 trigger, UART trigger burst, [601](#)
 trigger, UART trigger commands, [596](#)
 trigger, UART trigger data, [602](#)
 trigger, UART trigger idle, [603](#)
 trigger, UART trigger qualifier, [606](#)
 trigger, UART trigger type, [609](#)
 trigger, UART Tx data, [642](#)
 trigger, UART Tx source, [608](#)
 trigger, UART width, [610](#)
 trigger, USB, [615](#)
 trigger, USB D- source, [612](#)
 trigger, USB D+ source, [613](#)
 trigger, USB speed, [614](#)
 truncation rules, [788](#)
 TST (Self Test), [137](#)
 tstart, [719](#)
 tstop, [720](#)
 TTL threshold voltage for digital channels, [243, 695](#)
 TTL trigger threshold voltage, [741](#)
 turn function on or off, [705](#)
 turn off channel, [148](#)
 turn off channel labels, [249](#)
 turn off cursors, [144](#)
 turn off digital pod, [148](#)
 turn off math function, [148](#)
 turn off measurements, [144](#)
 turn off trace memories, [144](#)

turn off zoomed time base mode, [144](#)
 turn on channel labels, [249](#)
 turn on channel number display, [700](#)
 turn on channels, [144](#)
 turning channel display on and off, [222](#)
 turning off/on function calculation, [268](#)
 turning vectors on or off, [699](#)
 TV mode, [592, 742](#)
 TV trigger commands, [590](#)
 TV trigger line number setting, [591](#)
 TV trigger mode, [594](#)
 TV trigger polarity, [593](#)
 TV trigger standard setting, [595](#)
 TV triggering, [469](#)
 tvmode, [742](#)
 Tx data, UART, [642](#)
 Tx frame count (UART), [443](#)
 Tx source, [608](#)
 type, [196, 643](#)
 TYPE commands, [683](#)

U

UART base, [598](#)
 UART baud rate, [599](#)
 UART bit order, [600](#)
 UART commands, [683](#)
 UART frame counters, reset, [441](#)
 UART parity, [604](#)
 UART polarity, [605](#)
 UART Rx source, [607](#)
 UART trigger burst, [601](#)
 UART trigger commands, [596](#)
 UART trigger data, [602](#)
 UART trigger idle, [603](#)
 UART trigger qualifier, [606](#)
 UART trigger type, [609](#)
 UART Tx data, [642](#)
 UART Tx source, [608](#)
 UART width, [610](#)
 UART/RS-232 triggering, [469](#)
 UNITS commands, [684](#)
 units per division, [234, 235, 263, 462](#)
 units per division (vertical) for function, [234, 276](#)
 units, automask, [365](#)
 unsigned data, [622](#)
 unsigned mode, [644](#)
 update rate, waveform, [450](#)
 UPPer commands, [684](#)
 upper threshold, [327](#)
 upper threshold channel, M1553 trigger, [571](#)
 upper threshold voltage for measurement, [723](#)
 uppercase characters in commands, [787](#)
 URQ (User Request) status bit, [119, 121](#)
 USB (Device) interface, [37](#)
 USB source, [612, 613](#)
 USB speed, [614](#)
 USB trigger, [615](#)
 USB trigger commands, [611](#)
 USB triggering, [469](#)
 user defined channel labels, [225](#)

Index

user defined threshold, [695](#)
user event conditions occurred, [135](#)
User's Guide, [4](#)
user-defined threshold voltage for digital channels, [243](#)
user-defined trigger threshold, [741](#)
USR (User Event bit), [133](#), [135](#)
Utility button, [37](#), [38](#)
utilization, CAN bus, [426](#)

V

valid command strings, [787](#)
valid pattern time, [490](#), [491](#)
value, [344](#)
value measured at base of waveform, [348](#)
value measured at specified time, [354](#)
value measured at top of waveform, [355](#)
value ranges, [109](#)
values required to fill time buckets, [185](#)
VBA, [48](#), [812](#)
vectors, [253](#)
vectors turned on or off, [699](#)
vectors, turning on or off, [244](#)
vernier, channel, [236](#)
vernier, horizontal, [463](#)
vertical adjustment, fine (vernier), [236](#)
vertical amplitude measurement, [346](#)
vertical axis defined by RANGE, [274](#)
vertical axis range for channels, [233](#)
vertical offset for channels, [226](#)
vertical peak-to-peak measured on waveform, [351](#)
vertical scale, [234](#), [276](#)
vertical scaling, [633](#)
vertical threshold, [695](#)
vertical value at center screen, [272](#), [275](#)
vertical value maximum measured on waveform, [349](#)
vertical value measurements to calculate overshoot, [325](#)
vertical value minimum measured on waveform, [350](#)
video line to trigger on, [591](#)
video standard selection, [595](#)
view, [180](#), [266](#), [645](#), [700](#)
view turns function on or off, [705](#)
VISA COM example in C#, [822](#)
VISA COM example in Visual Basic, [812](#)
VISA COM example in Visual Basic .NET, [834](#)
VISA example in C, [845](#)
VISA example in C#, [864](#)
VISA example in Visual Basic, [854](#)
VISA example in Visual Basic .NET, [877](#)
VISA examples, [812](#), [845](#)
Visual Basic .NET, VISA COM example, [834](#)
Visual Basic .NET, VISA example, [877](#)
Visual Basic 6.0, [49](#)
Visual Basic for Applications, [48](#), [812](#)
Visual Basic, SICL library example, [900](#)
Visual Basic, VISA COM example, [812](#)
Visual Basic, VISA example, [854](#)

voltage crossing reported or not found, [721](#)
voltage difference between data points, [649](#)
voltage difference measured, [724](#)
voltage level for active trigger, [501](#)
voltage marker used to measure waveform, [725](#), [726](#)
voltage offset value for channels, [226](#)
voltage probe, [235](#), [263](#)
voltage ranges for channels, [233](#)
voltage ranges for external trigger, [262](#)
voltage threshold, [317](#)

W

WAI (Wait To Continue), [138](#)
wait, [138](#)
wait for operation complete, [124](#)
Wait Trig bit, [165](#), [167](#)
waveform base value measured, [348](#)
WAVEform command, [47](#)
WAVEform commands, [616](#), [684](#)
waveform data, [618](#)
waveform data format, [417](#)
waveform data length, [418](#)
waveform data, save, [416](#)
waveform introduction, [618](#)
waveform maximum vertical value measured, [349](#)
waveform minimum vertical value measured, [350](#)
waveform must cross voltage level to be an occurrence, [721](#)
WAVEform parameters, [52](#)
waveform peak-to-peak vertical value measured, [351](#)
waveform period, [327](#)
waveform persistence, [244](#)
waveform RMS value measured, [353](#)
waveform save option for segments, [419](#)
waveform source channels, [638](#)
waveform source subsource, [642](#)
waveform standard deviation value measured, [335](#)
waveform update rate, [450](#)
waveform vertical amplitude, [346](#)
waveform voltage measured at marker, [725](#), [726](#)
waveform, byte order, [624](#)
waveform, count, [625](#)
waveform, data, [626](#)
waveform, format, [628](#)
waveform, points, [629](#), [631](#)
waveform, preamble, [633](#)
waveform, source, [638](#)
waveform, type, [643](#)
waveform, unsigned, [644](#)
waveform, view, [645](#)
waveform, X increment, [646](#)
waveform, X origin, [647](#)
waveform, X reference, [648](#)
waveform, Y increment, [649](#)
waveform, Y origin, [650](#)

waveform, Y reference, [651](#)
WAVEform:FORMat, [52](#)
WAVEforms commands, [685](#)
waveforms, mask test run, [384](#)
Web control, [57](#)
what's new, [21](#)
width, [524](#), [610](#)
WIDTh commands, [685](#)
window, [464](#), [465](#), [466](#)
window time, [459](#)
window time base mode, [457](#)
windows, [280](#)
windows as filters to Fast Fourier Transforms, [280](#)
windows for Fast Fourier Transform functions, [280](#)
word format, [628](#)
word format for data transfer, [622](#)
word select (WS) low, I2S trigger, [543](#)
word select (WS) source, I2S, [539](#)
word width, SPI decode, [438](#)
write text to display, [447](#)
write trace memory, [247](#)
WriteEEBlock method, [49](#), [55](#)
WriteList method, [49](#)
WriteNumber method, [49](#)
WriteString method, [49](#)

X

X axis markers, [296](#)
X delta, [302](#)
X delta, mask scaling, [387](#)
X1 and X2 cursor value difference, [302](#)
X1 cursor, [296](#), [298](#), [299](#)
X1, mask scaling, [386](#)
X2 cursor, [296](#), [300](#), [301](#)
X-axis functions, [456](#)
XDELta commands, [685](#)
X-increment, [646](#)
X-of-max measurement, [356](#)
X-of-min measurement, [357](#)
X-origin, [647](#)
X-reference, [648](#)
X-Y mode, [456](#), [457](#)

Y

Y axis markers, [296](#)
Y1 and Y2 cursor value difference, [305](#)
Y1 cursor, [296](#), [299](#), [303](#), [305](#)
Y1, mask scaling, [388](#)
Y2 cursor, [296](#), [301](#), [304](#), [305](#)
Y2, mask scaling, [389](#)
Y-axis value, [650](#)
YDELta commands, [686](#)
Y-increment, [649](#)
Y-origin, [650](#), [651](#)
Y-reference, [651](#)

Z

- zero values in waveform data, [626](#)
- zoomed time base, [457](#)
- zoomed time base mode, how autoscale affects, [144](#)
- zoomed window horizontal scale, [466](#)

